



Agricultural Equipment and Supplies 2021 / 2022



Dear customer,

Tras Following the conclusion of several highly successful years in partnership with the Kerbl Group, we are delighted to present another joint agricultural requirements catalogue to you this year.

Due to this cooperation with the Kerbl Group, we will now be able to offer you an even larger range of products: choose from over 10,000 additional items from our product range and continue to profit from products of the highest quality, distributed by the Kerbl Group as an experienced and reliable partner with excellent service.











GEA Farm Technologies, based in Bönen, provides farmers with integrated product and application solutions for milk production and animal husbandry, which range from the design and planning of stable and operating concepts to daily herd and operational management. With its combined technical expertise in the areas of milk production, manure technology, stable facilities, automatic feeding systems as well as up-to-date services, including hygiene services, the product range covers all herd sizes all over the world, as well as all customer requirements based on the various types of operations involved.

The parent company, GEA Group Aktiengesellschaft, is one of the largest system suppliers for the food processing industry as well as a wide range of other process industries. As an international technology group, it focusses on process technology and components for sophisticated production processes in various end markets.

See for yourself our extensive range of high-quality products with a balanced price-performance ratio in the new edition of our Agricultural Supplies catalogue.



GEA Farm Technologies GmbH & Kerbl Group

	GEA Exclusive Programme	04 - 17		Stable and Yard Essentials	167 - 192		Veterinary Equipment	202
				Scales and Measuring Devices Shovels and Forks Moisture Level Readers Stable and Yard Lighting Lashing and Lifting				
	Calf Rearing	18 - 65					Sheep Breeding and Farming	203 - 209
	Camera Surveillance Veterinary Obstetrics Dietary Supplements						Lamb Rearing Hoof Care Clippers	
	Dairy Farming	67 - 93		Pest Control	193 - 200			
	Udder Care and Milking Hygiene Milk Filters Milking Accessories			Electric Insect Control Chemical Insect Control Rat and Mouse Control				
	Cattle Breeding and Cattle Farming	94 - 166		Pig Breeding and Pig Farming	201		Safety in the workplace	210 - 230
	Dehorning Weaning Supplies Bandages and Bindings Hoof and Claw Care Grooming Marking Troughs and Hay Racks Drinking Bowls and Frost Protection						Protective Clothing Boots Gloves	

Explanation of our packaging and sales units.

OU	Items/pack unit	€
1 blister pack	Pack of 6	Price per pack
1 pouch	Pouch of 10	Price per pouch
12 items	Pouch of 12	Price per item
1 pack	Pack of 30	Price per pack
40 items	Pack of 40	Price per item
1 box	Box of 5	Price per box
8 items	Box of 8	Price per item
1 display	Display of 10	Price per display
6 items	Display of 6	Price per item

OU
Order unit for retail
Always order a multiple of the number stated (e.g. OU = 12 items, order in lots of 12).

Items/pack unit
No. of items per order unit/pack unit

Price/€
Price per OU
If the OU column is empty or missing, the price is per item. All prices provided are the manufacturer's recommended retail prices and are inclusive of VAT.



Pack units

Possible pack units for 1 OU.



Pallet

No. of order units (OU) per pallet.



Forwarder

All items marked with this icon must be shipped by freight carrier due to their scale/size or weight. This means that additional, separate freight costs are required! Optimise freight costs by ordering entire pallet units.

Professional product advice

Do you require specific advice on our products?

Our specially trained product experts are available for your questions and can provide detailed information at any time via phone or e-mail for the following product areas.

For more information about these product areas, please go to our website.

Service department	Telephone	E-mail
IP Camera		
Germany:	+49 8086 933-545	support_ipcam@kerbl.com
Austria:	+43 4224 81555-645	kamera@kerbl-austria.at
International:	+49 8086 933-545	support_ipcam@kerbl.com
LED Lighting		
Germany:	+49 8086 933-551	led@kerbl.com
Austria:	+43 4224 81555-646	led@kerbl-austria.at
International:	+49 8086 933-551	led@kerbl.com
Drinking Technology		
Germany:	+49 8086 933-520	traenketechnik@kerbl.com
Austria:	+43 4224 81555-647	traenketechnik@kerbl-austria.at
International:	+49 8086 933-520	drinkingbowls@kerbl.com
Clippers		
Germany:	+49 8086 933-552	schermaschinen@kerbl.com
Austria:	+43 4224 81555-648	schermaschinen@kerbl-austria.at
International:	+49 8086 933-552	clippers@kerbl.com
Pest Control		
Germany:	+49 8086 933-554	schaedlingsbekaempfung@kerbl.com
Austria:	+43 4224 81555-649	schaedlingsbekaempfung@kerbl-austria.at
International:	+49 8086 933-554	pestcontrol@kerbl.com
Fencing		
Germany:	+49 8086 933-577	weidezaun@kerbl.com
Austria:	+43 4224 81555-651	weidezaun@kerbl-austria.at
International:	+49 8086 933-577	fencing@kerbl.com
Hoof Care		
Germany:	+49 8086 933-541	klauenpflege@kerbl.com
Austria:	+43 4224 81555-653	klauenpflege@kerbl-austria.at
International:	+49 8086 933-541	clawcare@kerbl.com
Feed		
Germany:	+49 8086 933-321	futter@kerbl.com
Austria:	+43 4224 81555-652	futter@kerbl-austria.at
International:	+49 8086 933-321	supplementfeed@kerbl.com
Hobby Farming		
Germany:	+49 8086 933-323	hobbyfarming@kerbl.com
Austria:	+43 4224 81555-655	hobbyfarming@kerbl-austria.at
International:	+49 8086 933-323	hobbyfarming@kerbl.com
Smartfarming		
Germany:	+49 8086 993-301	smartfarming@kerbl.com
Austria:	+43 4224 81555-654	smartfarming@kerbl-austria.at
International:	+49 8086 993-301	smartfarming@kerbl.com



Discover our range of online services.

Just as we are constantly striving to improve our existing products and develop new ones, we are mindful too of our services that accompany our product portfolio.

With our free newsletter and news on our website, we pick out exclusive products and topics of seasonal interest for you and provide you with information on very special offers. We also endeavour to make your product experience more extensive and informative with videos, brochures and other information.

We'd like to give you a closer look at a few of our highlights here.

Browsing catalogue and service pages

If you don't have one of our catalogues to hand, or simply want to browse through our collection with the 'true' catalogue feeling, then our online browsing catalogue is exactly what you need. It combines the advantages of a catalogue and online browsing: a search function makes finding items easier and takes you direct from every page back to the website, which contains more detailed information.

The services pages on our website also contain generally useful forms such as repair requests, pick-up requests for dry batteries and return slips.

Better product presentation with videos, 360° photo player and downloads

Product videos

You can now find out even more about our products in appealing, informative and attractive product videos.



All features and functions are shown live in action. We also present areas of use that some people may previously have been unaware of. Explanatory and installation videos facilitate operation and clarify features. In this way, we are trying to answer questions on products in advance and also provide you with real added value.

360° photo player

We are also offering complete 360° views of selected products in addition to our high-resolution professional product photos.



This gives you the option of viewing the product in advance from all sides and in extreme close-up, in high resolution and in sharp focus. Although you still cannot touch it, you can get a much better, more realistic feel for the product.

Product images

While we can only show you basic illustrations of a product in our catalogue, we can also provide you with digital copies of further photos showing detailed views and usage, for example.



Downloads

Just on the right, next to the picture of the product, is the download box in which you can find further information such as brochures or operating instructions.



Kerbl goes Social Media

You too can find us on social media, on Facebook, Instagram and YouTube. This way, you won't miss out on Kerbl's latest news about our company, products and activities.

You can find an overview of all social media channels at:
<https://www.kerbl.de/socialmedia>

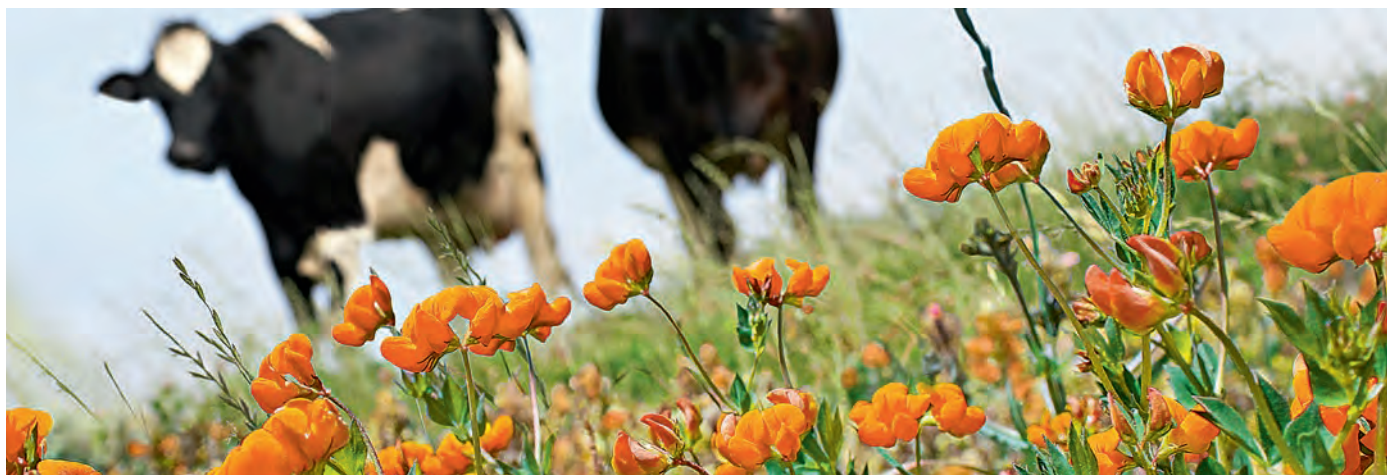

New GEA Products 2020

GEA Supplies Set Economy

Set consisting of: 1 x GEA Spray Oil WL-75, 500 ml, 1 x Original GEA Glide Silicone Spray, 400 ml, 1 x GEA Udder Paper ProfilacDermacel, 350 sheets/roll, 1 x Stainless Steel Wall Mount for Disposable Gloves, with Spring, 1 x IPCam 2.0 HD, 1 x black Disposable Nitrile Gloves, size XL, 100 pcs/pack



Ref. no.	GEA no.	Description		€
151200-GEA	7315-5153-000	GEA Supplies Set Economy	1	

GEA Supplies Set Premium

Set consisting of: 1 x GEA Cattle Clippers, 1 Battery, GT503/GT504, 1 x Udder Hair Remover with Curved Lance, 1.5 m Hose with Gas Cartridge Connector, 1 x Gas Cartridge for Udder Hair Remover, 340 g (600 ml), 1 x Electronic Fly Killer EcoKill Inox, 2 x 20 W, IPX4, 1 x Ultrasound Device Felix 400





Ref. no.	GEA no.	Description		€
151201-GEA	7315-5153-100	GEA Supplies Set Premium	1	

GEA Spray Oil WL-75

Versatile universal oil for various applications in agriculture.

Made in Germany



Ref. no.	GEA no.	Contents			€
151850-GEA	7315-4974-800	500 ml / Spray Can	1/12	840	

GEA Vacuum Pump Oil VCL 22

The original Vacuum Pump Oil VCL 22 is specially designed for lubricating GEA vacuum pumps. The reliability of your vacuum pump has been confirmed through extensive testing with VCL 22.

- for vacuum pump lubrication
- made from ultra-pure base oils
- contains anti-corrosion additive, ensuring your vacuum pump is resistant to ageing
- certified according to DIN 51 502 Class VCL

Made in Germany





151825-GEA

151826-GEA

151827-GEA

151823-GEA

Ref. no.	GEA no.	Contents	MOQ	Pieces / unit			€
151823-GEA	7315-0809-000	1 L / Bottle	6 pieces	6 / box	1/6	264	
151824-GEA	7315-0810-000	5 L / Canister	2 pieces	2 / box	1/2	96	
151825-GEA	7315-0811-000	10 L / Canister			1	20	
151826-GEA	7315-0812-000	200 L / Barrel			1	2	
151827-GEA	7315-0813-000	30 L / Canister			1	16	

GEA Vacuum Pump Oil for Miele

- tested for vacuum pumps from Miele

Made in Germany



Ref. no.	GEA no.	Contents			€
151822-GEA	7315-0808-000	5 L / Canister	1/4	96	



GEA Glide

Silicone and Rubber Care Spray

- reduced assembly time and effort
- maintains and protects long-term
- prevents premature ageing in the long term and increases longevity
- prevents seals freezing solid
- colour-refreshing effect, improves the aesthetics
- approved for silicone liners, silicone hoses and all rubber parts for milking machines

Made in Germany



Ref. no.	GEA no.	Contents	MOQ	Pieces / unit			€
291207-GEA	7315-2394-000	400 ml / Spray Can	6 pieces	6 / box	1/6	870	



GEA Milk Filter Sock

- for vacuum systems
- gentle passage during filtration
- high-quality, food-safe material

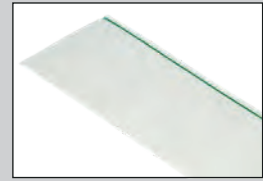

GEA Milk Filter Sock 70 g/m²

Our proven standard filter for everyday use

- 70 g/m² • food safe • sewn

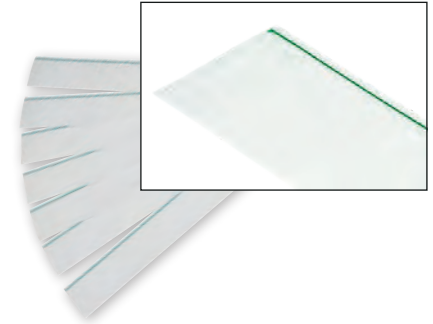

Ref. no.	GEA no.	Width	Length	Suitable for	MOQ	Pieces / unit		€
46278-GEA	7319-0001-000	57 mm / 60 mm	250 mm	GEA / Lister / Meltec / Lemmer Fullwood	4 pack	370 / box	1/4	
46192-GEA	7315-4976-000	57 mm / 60 mm	320 mm	DeLaval / Hand / Flaco / Utina / Gascoigne-Melotte	1 pack	370 / box	1/4	
46280-GEA	7319-0002-000	57 mm / 60 mm	455 mm	GEA / Meltec / Gascoigne-Melotte	4 pack	370 / box	1/4	
46283-GEA	7319-0004-000	57 mm / 60 mm	530 mm	Lemmer Fullwood / GEA (Mlone)	4 pack	370 / box	1/4	
46286-GEA	7319-0006-000	75 mm / 78 mm	605 mm	GEA / Boumatic / S.A.C.	8 pack	200 / box	1/8	
46197-GEA	7315-4976-100	57 mm / 60 mm	620 mm	DeLaval / Hand / Flaco / DEC / Gascoigne-Melotte	1 pack	370 / box	1/4	
46290-GEA	7319-0007-000	75 mm / 78 mm	800 mm	GEA / Impulsa / Meltec	1 pack	200 / box	1/10	
46534-GEA	7315-5062-100	124 mm	914 mm	AR Performer	1 pack	200 / box	1/4	
46535-GEA	7315-5062-200	124 mm	851 mm	Meltec / Westfalia Systemat	1 pack	200 / box	1/4	
46536-GEA	7315-5062-300	51 mm	610 mm	Meltec	1 pack	200 / box	1/10	

GEA Milk Filter Sock 100 g/m²

- 100 g/m² • food safe • sewn

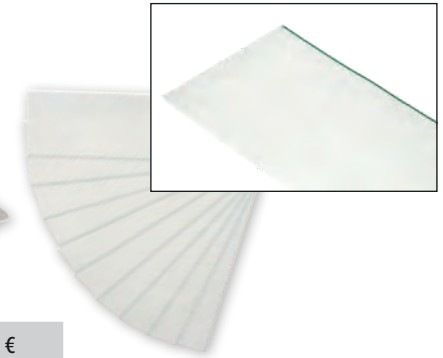

Ref. no.	GEA no.	Width	Length	MOQ	Pieces / unit		€
46289-GEA	7315-4936-000		790 mm	1 pack	200 / pack	1/4	
46293-GEA	7315-4934-000		850 mm	1 pack	50 / pack	1/9	

GEA Milk Filter Sock 120 g/m²

The sturdy one for continuous use and high wear recommended especially for milking robots

- 120 g/m² • food safe • sewn





Ref. no.	GEA no.	Width	Length	Suitable for	MOQ	Pieces / unit		€
46284-GEA	7319-0005-000	57 mm / 60 mm	530 mm	Lemmer Fullwood / GEA (Mlone) / GEA Monobox	1 pack	100 / pack	1/10	
46285-GEA	7315-4933-000	75 mm / 78 mm	605 mm	GEA / Boumatic / S.A.C. / Lely (Robotic Milker)	1 pack	100 / pack	1/8	
46281-GEA	7315-4931-000	57 mm / 60 mm	455 mm	GEA / Meltec / Gascoigne-Melotte	1 pack	100 / pack	1/10	
46287-GEA	7315-4932-000	57 mm / 60 mm	620 mm	DeLaval / Hand / Flaco / DEC / Gascoigne-Melotte	1 pack	100 / pack	1/10	
46291-GEA	7319-0008-000	75 mm / 78 mm	800 mm	GEA / Impulsa / Meltec	1 pack	100 / pack	1/10	
46292-GEA	7315-4935-000	125 mm	860 mm	Miscellaneous	1 pack	100 / pack	1/4	

GEA Milk Filter Sock 140 g/m²

The all-rounder for the highest requirements

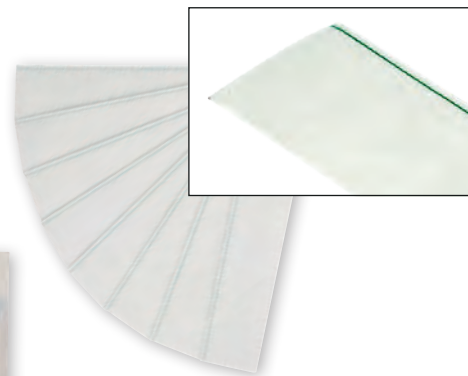
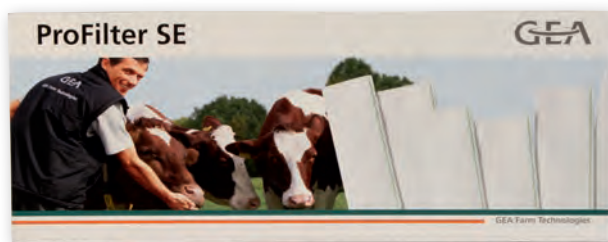
• 140 g/m² • food safe • sewn



Ref. no.	GEA no.	Width	Length	MOQ	Pieces / unit		€
46520-GEA	7315-4918-000	57 mm / 60 mm	455 mm	1 pack	100 / pack	1/10	
46521-GEA	7315-4919-000	57 mm / 60 mm	530 mm	1 pack	100 / pack	1/10	
46522-GEA	7315-4920-000	57 mm / 60 mm	620 mm	1 pack	100 / pack	1/10	
46523-GEA	7315-4921-000	75 mm / 78 mm	605 mm	1 pack	100 / pack	1/8	
46524-GEA	7315-4922-000	75 mm / 78 mm	800 mm	1 pack	100 / pack	1/10	

GEA Milk Filter Sock 55 g/m²

The slim one for use in milking machines for sheep and goats

• 55 g/m² • food safe • sewn

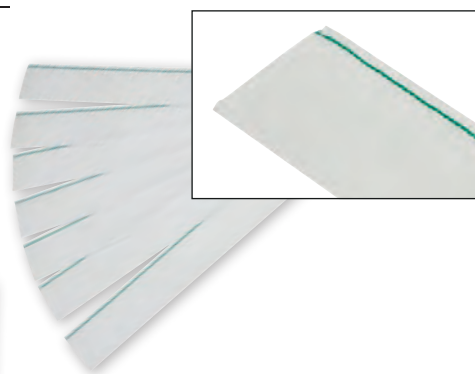

Ref. no.	GEA no.	Width	Length	Suitable for	MOQ	Pieces / unit		€
46282-GEA	7319-0003-000	57 mm / 60 mm	455 mm	GEA / Meltec / Gascoigne-Melotte	1 pack	250 / pack	1/4	

GEA Filter Disc

• suitable for GEA Pulsators



Ref. no.	GEA no.	Width	Length	Surface weight	Suitable for	MOQ	Pieces / unit		€
46274-GEA	7315-4106-000	50 mm	110 mm	38 g/m ²	Constand Pulsator (before 1987)	1 pack	12 / pack	1	
46275-GEA	7315-4107-000	50 mm	116 mm	38 g/m ²	Constand Pulsator (from 1987)	1 pack	12 / pack	1/1.000	
46276-GEA	7315-4108-000	46,5 mm	70 mm	80 g/m ²	Reversing valves, solenoid valves	1 pack	12 / pack	1	



GEA Milk Tube Cleaning Sponge

• for removing residue in milk tubes in vacuum systems • can be used multiple times, simply rinse out with warm water • reliable • compressed front surface • Material: polyurethane

white sponge:
after milking
grey sponge:
after rinsing

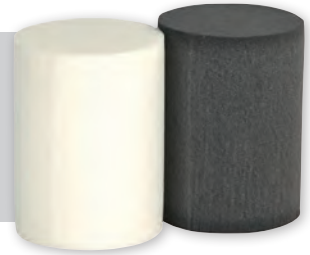

Ref. no.	GEA no.	Description	MOQ	Pieces / unit		€
46271-GEA	7315-4103-000	for Plexiglas lines diam. 40 mm	1 pack	12 / pack	1/10	
46272-GEA	7315-4104-000	for 40 mm diam. stainless steel pipes	1 pack	12 / pack	1/7	
46273-GEA	7315-4105-000	for Plexiglas and stainless steel lines diameter 50 mm	1 pack	12 / pack	1/6	

GEA Udder Paper Sowotaan 200

• high-quality single-use udder paper • extra strong wet strength • well-suited for moist udder cleaning with water or an udder cleaning solution



Made in Germany



Instructions for use:

Cleaning udders with udder paper should take place after pre-milking so that any germs in the pre-milk do not remain on the udder. Please use a clean udder cloth for each animal.





Ref. no.	GEA no.	Colour	Contents	MOQ	Pieces / unit			€
15831-GEA	7315-0742-000	white	200 sheet / Roll	1 pack	10 / pack	1	63	

GEA Udder Paper Sowotaan Jumbo

• high-quality single-use udder paper • extra strong wet strength
• well-suited for moist udder cleaning with water or an udder cleaning solution • can also be used when dry

Made in Germany



Ref. no.	GEA no.	Colour	Contents	MOQ	Pieces / unit			€
15833-GEA	7315-0744-000	white	1000 sheet / Roll	1 pack	6 / pack	1	36	



GEA Udder Paper ProfilacDermacel



- highly absorbent and stable udder paper in Airlaid quality • well-suited for dry udder cleaning • roughened surface removes dirt from the udder • teat-stimulating
- recommended for cleaning your robot's camera



Made in Germany



Recommended for GEA CameraCleanse AMS & GEA CameraCleanse descaler AMS



Ref. no.	GEA no.	Colour	Contents	MOQ	Pieces / unit			€
15832-GEA	7315-0743-000	white	350 sheet / Roll	1 pack	6 / pack	1	36	

GEA Udder Paper Sowotaan Wet

- wet single-use udder paper for wet-cleaning of udders • as a starter kit, we recommend ordering the Udder Paper (15837-GEA) and the bucket with lid (15786-GEA) together



Soaked in Original GEA Udder Cleaner!



Ref. no.	GEA no.	Colour	Contents	MOQ	Pieces / unit			€
15837-GEA	7315-4950-000	white	900 sheet / Roll	2 pack	2 / pieces	1/2	120	

Ref. no.	GEA no.	Description	Colour	Material		€
15823		Holder for udder cloth bucket		stainless steel	1/10	
15834-GEA	7315-4975-400	Bucket empty no lid	white		1	
15786-GEA	7315-4974-400	Bucket empty with lid	white		1	

GEA Udder Cloth ProfilacDermatex

- reusable fleece udder cloth • washable up to 300 x • best cleaning results thanks to surface with excellent grip • Material: Non-woven fabric





Ref. no.	GEA no.	Colour	Contents	Sheet dimensions (L x W)			€
15666-GEA	7315-4971-000	green	50 sheet / Pack	340 x 370 mm	1/6	72	
15667-GEA	7315-4972-000	green	50 sheet / Pack	270 x 290 mm	1/8	128	



GEA Dip Cup NonReturn

• a return flow protection prevents used dip material from flowing back into the bottle • clean dip material, full effect on the cow teats • specially developed splash guard with draining to an overflow chamber: less overflow, less waste • soft plastic bottle for low-fatigue working even for a large animal population • practical belt hook

Ref. no.	GEA no.	Colour	Capacity			€
15643-GEA	7315-4975-000	green	300 ml	1/132	792	

Ref. no.	GEA no.	Description	Colour		€
15646-GEA	7315-5066-300	Replacement Bottle	white transparent	1/200	





The ORIGINAL



GEA Dip Cup NonReturn Twin

• excellent for light applications of film-forming or „barrier dips“ with high viscosity • double hose accepts the same amount of dip medium, but only requires half the power for pressing • a return flow protection prevents used dip material from flowing back into the bottle • clean dip material, full effect on the cow teats • specially developed splash guard with draining to an overflow chamber: less overflow, less waste • soft plastic bottle for low-fatigue working even for a large animal population • practical belt hook

Ref. no.	GEA no.	Colour	Capacity			€
15647-GEA	7315-4975-100	green	300 ml	1/132	792	

Ref. no.	GEA no.	Description	Colour		€
15646-GEA	7315-5066-300	Replacement Bottle	white transparent	1/200	

for viscous media



GEA Dip Cup NonReturn Cross

• cross dip cup with return flow protection • suitable for cows, goats and sheep • dip loss is avoided due to the unique dip medium container with a drip guard edge • with a double hose so that viscous, film-forming media can be used • soft plastic bottle for low-fatigue working even for a large animal population • practical belt hook

Ref. no.	GEA no.	Colour	Capacity		€
15649-GEA	7315-4975-300	green	300 ml	1/150	

Ref. no.	GEA no.	Description	Colour		€
15646-GEA	7315-5066-300	Replacement Bottle	white transparent	1/200	

for viscous media



GEA Dip Cup FoamExpert+

• patented foaming system • suitable for various dip materials, several valve inserts are available • can be used with different foaming dip materials • quick, uniform foaming via just compression • extremely fine and uniform foaming • less dip consumption due to very effective wetting of the teats • hygienic, as side air inlet has a cover • easy to disassemble for cleaning • for pre-milking and post-milking disinfection

Ref. no.	GEA no.	Colour		€
15669-GEA	7315-5074-500	green	1/132	

Ref. no.	GEA no.	Description	Colour		€
15646-GEA	7315-5066-300	Replacement Bottle	white transparent	1/200	



foaming



GEA Dip Cup FoamExpert

- with special foaming sleeve insert in the container • practical belt hook

Ref. no.	GEA no.	Colour	Capacity			€
15648-GEA	7315-4975-200	green	300 ml	1/132	528	



Ref. no.	GEA no.	Description	Colour		€
15646-GEA	7315-5066-300	Replacement Bottle	white transparent	1/200	



foaming

GEA Dip Sprayer PortaSpray

- high-quality spray head with metal nozzle • specially angled spray nozzle for optimum teat cleaning and spot-accurate dipping • only use sprayable dipping agents

Ref. no.	GEA no.	Colour	Capacity			€
15642-GEA	7315-4974-900	green	600 ml	1/100	400	



GEA Teat Spraying System ProStream

teat spraying system with adjustable nozzle. Can be used as a mastitis prophylaxis with dip media or as a spraying system for interim disinfection of the milking cup. A self-regulating pressure valve always ensures an optimum spray mist. The supply of up to 50 spray guns is possible so that this system can grow as your business grows. No electrical connection required.

- with a tried and true spraying mechanism • with a vacuum-operated spray pump, supply hose, 3 flexible spiral hoses and 3 spray guns



Adjustable pressure

- Achieves the best spray results using any agents of your choice

Self-regulating pressure



- Ensures stable flow for up to 5 simultaneously active spray pistols

Relief valve

- De-pressurises the system via a valve when the vacuum is switched off and triggers a backwash of the filter in the dipping agent feed

Expandable up to 50 spray pistols

- Adjustable to the requirements of the largest herds

Ref. no.	GEA no.	Description			€
151846-GEA	7315-5084-000	Base device with 3 spray tubes	1	15	
151847-GEA	7315-5084-100	Base device	1	15	

Ref. no.	Description	Length		€
151845	Spray Gun ProStream with handle	30 cm	1/200	
151844	Spray Tube ProStream without handle	16 cm	1	
151843	Spiral Hose ProStream for teat spraying system		1/40	
151841	Extension Set ProStream with 1 m lance		1/40	
151840	Spare Parts Set ProStream		1	

GEA Disposable glove Nitril

- textured, therefore providing excellent grip • especially suitable as a milking glove: white flakes in the milk, a sign of mastitis, can be detected more easily on the black background • ambidextrous • non-sterile • complies with: EN 455 • tested according to: EN 374-1 • free from allergy inducing nitrosamines, thiurames, thiazoles and latex proteins, latex-free, Free of powder • 1.5 AQL (quality standard) • food safe



EN ISO 374-5:2016





EN ISO 374-1:2016
Type B



JKPT





Ref. no.	GEA no.	Colour	Size	Length	Material thickness	MOQ	Pieces / unit			€
15315-GEA	7315-5151-200	black	6.5-7 / S	24 cm	5,5 mil = 0,13 mm	1 pack	100 / pack	1/10	360	
15316-GEA	7315-5151-300	black	7.5-8 / M	24 cm	5,5 mil = 0,13 mm	1 pack	100 / pack	1/10	360	
15317-GEA	7315-5151-400	black	8.5-9 / L	24 cm	5,5 mil = 0,13 mm	1 pack	100 / pack	1/10	360	
15318-GEA	7315-5151-500	black	9.5-10 / XL	24 cm	5,5 mil = 0,13 mm	1 pack	100 / pack	1/10	360	
15319-GEA	7315-5151-600	black	10.5-11 / XXL	24 cm	5,5 mil = 0,13 mm	1 pack	100 / pack	1/10	360	

GEA Wall bracket for disposable gloves

- made from stainless steel: heavy-duty and rust-free, even in wet conditions (e.g. in the milking station) • screw-on fastening • can be affixed vertically and horizontally • stable position and suitable for all sizes thanks to spring that pushes the dispenser box to the front



Ref. no.	GEA no.	Material			€
15339-GEA	7315-5151-700	stainless steel	1/8	192	

GEA Hygiene Apron

This food-grade apron is made from particularly lightweight material, for low-fatigue working. Contaminants hardly stick to the aprons, as they are manufactured without seams or eyelets and feature a pore-free surface. The aprons are ideally suited for use in hygienic areas, as they are detectable. This ensures that no product particles remain in foods.

- made from high-quality, thermoplastic polyurethane (TPU) • Food safe as per (EU) No. 1935/2004 • detectable
- extremely tear- and abrasion-resistant with very high elasticity • especially pleasant wearing comfort for low-fatigue working • material resistant to cleaning agents • can be sterilised and disinfected • Temperature resistance: -20 °C
- food safe • machine washable at 95 °C



Ref. no.	GEA no.	Colour	Length	Width		€
15606-GEA	7315-5067-500	green	155 cm	90 cm	1/20	



GEA Milker Apron

• extra-durable Pro Milker Apron for working at the milking station and dairy room • extremely tear and kink-proof • washable and made from a durable, flexible material • limited acid resistance • Temperature resistance: -30 - 50 °C

Composition	
Textile	100 % Polyester
Coating	100 % PVC

Ref. no.	GEA no.	Colour	Size	Length	Width		€
15613-GEA	7315-0677-000	green	M	115 cm	100 cm	1/20	
15614-GEA	7315-0678-000	green	L	125 cm	118 cm	1/20	
15615-GEA	7315-0679-000	green	XL	140 cm	124 cm	1/20	



GEA Milker Apron

with pockets

• extra-durable Pro Milker Apron for working at the milking station and dairy room • with pockets for milking utensils • with shoulder straps and an additional strap for closing at the front and back • each pocket has 2 water drains • extremely tear and kink-proof • limited acid resistance • washable and made from a durable, flexible material • Temperature resistance: -30 - 50 °C

Composition	
Textile	100 % Polyester
Coating	100 % PVC

Ref. no.	GEA no.	Colour	Size	Length	Width		€
15616-GEA	7315-0680-000	green	S	110 cm	118 cm	1/40	
15617-GEA	7315-0681-000	green	L	125 cm	118 cm	1/20	



GEA Protective Sleeve

• adjustable on the upper strap • well-suited for working in side-by-side milking stations • waterproof milking sleeves • elasticated strap at both ends • in pairs

Composition	
Textile	100 % PVC

Ref. no.	GEA no.	Colour	Length	Pieces / unit		€
15398-GEA	7315-5075-000	green	50 cm	2 / pieces	1/100	



GEA Case for Dangerous Goods

Complies with GGVS and ADR guidelines

Personal protective equipment for use when transporting dangerous goods and in agriculture and industry when handling chemicals and cleaning products.

set includes: 1 x tightly fitting pair of goggles as per EN 166, 1 pair of nitrile gloves size 10 / XL as per EN 374, 1 x 250 ml eye wash bottle with 4.9 % phosphate buffer solution as per EN 15154-4, in a practical, dust-proof case 24 x 21 x 7.5 cm

Ref. no.	GEA no.		€
34508-GEA	7315-5314-300	1/16	

New product



NEW



GEA Milking Pail

- for daily use • can be used to check each individual cow's milk yield • also for mobile milking machines • suitable for GEA milking machines • suitable for GEA stainless steel covers • for colostrum or abnormal milk • Material: Polycarbonate
- with metal carry handle • with double fill scale (kg; lb) • food safe





Ref. no.	Colour	Capacity	Frame height			€
151052-GEA	green	30 L	14 cm	1	24	

Ref. no.	Description	Material	Ø		€
151058	Milking Pail Lid Supports ID 13 mm x AD 17 mm	Polycarbonate	205 mm	1/20	
151059	Milking Pail Lid Supports ID 16 mm x AD 20 mm	Polycarbonate	205 mm	1/20	
151060	Rubber Seal for milking pail covers			1/26	

GEA Udder Care Products SalvoCare Mint

- with peppermint oil • cares for stressed teats and udders • its nurturing ingredients keep the udder tissue supple • SalvoCare Mint also has a cooling effect that is pleasant for the animal • ensures a healthy udder and high-quality milk when used regularly • no waiting time



Ref. no.	GEA no.	Contents			€
15260-GEA	7315-0611-000	500 ml / Hanging Bottle	1/6	522	
15264-GEA	7315-0615-000	2500 ml / Dispenser bottle	1/3	144	
15310-GEA	7315-5074-000	1000 ml / Hanging Bottle	1/6	192	

Ref. no.	Description		€
15568	Dispenser for 2500 ml dispenser bottle	1/72	



GEA Cordless Clipper Cow

The GEA cordless clippers by Aesculap, fitted with lithium-ion batteries and a sleek and ergonomic design. The GEA clippers are also a perfect fit for women's hands and boast low weight, low noise and long battery life. The device is also fitted with an intelligent lithium-ion battery system. On the one hand, the battery technology protects the device from overheating and switches it off until it has cooled when the battery temperature reaches $>50^{\circ}\text{C}$. On the other hand, the charger provides information on the battery status with two LED displays.

- extremely light, just 900 g incl. batter and shaving blade
- just 40 mm diameter and 12.5 cm in circumference in the grip area, therefore also great for small hands
- very comfortable noise level
- very short and handy at 295 mm in length
- very well balanced
- Powerful and long-lasting
- lithium technology so no memory effect
- battery from tool professionals
- electronic push button recessed in the housing means no more accidental switching the machine on or off when handling
- Aesculap Clipper Blades Made in Germany

Included in delivery: 1 x cordless clippers, Li-ion Battery, 1 x charger, 1 x clipper blade set, 1 x small oil bottle, 1 x Durable plastic case



Green LED charge level indicator:
Flashing = battery charging / constant = battery full

Red LED battery indicator: Constant light = battery not being charged as temperature too high (above 50°C) / flashing = battery defective or foreign object between the charging contacts

Technical data	
Voltage	10,8 V
Clipper head system	Shearing Blade Set
Drive	DC motor
Stroke rate	approx. 2.500 strokes/min
Battery technology	Li-Ion
Battery capacity	2.000 mAh
Battery run time	80 min
Battery charge time	55 min
Sound pressure level	65 dB (A)
Dimensions	29,5 x 7,5 x 7,8 cm
Weight	900 g incl. battery and clipping head

Ref. no.	GEA no.		€
GT644-OG-GEA	7315-5151-800	1/8	

Ref. no.	Description	Weight		€
GT641	Spare Battery for Clippers	190 g	1/14	



- Calf blankets support the immune system during the first few days and prevent diarrhoea and other illnesses
- The risk of illness increases at temperatures below 10 °C
- Protection against sudden changes in the weather
- Avoids cold stress in new-born calves
- The calves generally wear the calf blankets for 3 to 4 weeks, and longer if necessary
- Calf blankets are not suitable for group housing

GEA Calf blanket

A high-quality calf blanket for optimum young animal protection. Great attention has been paid to the fit, the processing quality and material properties in order to meet the highest standards.

- durable and tearproof polyester 210D ripstop outer material
- thermo-insulating foam filling for maximum temperature control at a low weight
- technical material properties of the outer material: waterproof (5000 mm water column) and breathable (2000 g/m²)
- breathable and moisture-wicking fleece lining prevents excessive sweating and channels moisture away from the body
- tested and optimised fit
- flexible resizing by length-adjustable and elastic straps with snap fasteners on belly flap and leg straps, plus hook-and-loop fastener to the chest flap
- easy to clean
- breathable to 2000 g/m²/24 h
- machine washable at 30 °C



Ref. no.	GEA no.	Colour	Total length		€
14146-GEA	7315-5152-100	green	70 cm	1/30	
14147-GEA	7315-5152-200	green	80 cm	1/30	

GEA Calf Bucket with hygienic valve

... the one with the flap!

The newly developed hygienic valve with flap mechanism reduces germs and provides healthy growth for calves. The hygienic valve with flap was developed together with practitioners and uses a flap instead of a ball check valve, making it easy to clean with any kind of round brush. The removable intake manifold means no more inaccessible corners. The teat comes away from the valve in one movement. The bayonet fitting means the teat comes off and goes on again in no time. The drying aid is positioned on the side of the feeder handles, offering space to store the cleaned teat and bayonet ring. The bucket is transparent, allowing you to check the fill level from a distance.

- Easy to clean • food safe • with metal carry handle • acid-proof • with printed fill scale on the back, with additional embossed scale on the inside



The hygienic valve solves three problems with a single flap!

1. Easy to clean
2. Therefore fewer germs – healthier calves
3. Therefore lower veterinary costs



1441



1410



1454



Ref. no.	GEA no.	Colour	Capacity			€
14229-GEA	7315-5073-200	green transparent	8 L	1/5	180	

Ref. no.	GEA no.	Description	Colour	Material	Length	MOQ	Pieces / unit		€
1441		Cover for Feeding Bucket simply	grey					1/50	
1410		Mounting Bracket simply		metal galvanised		10 pieces	10 / pack	1/10/150	
1454		Calf Teat Latex	beige		100 mm	50 pieces	50 / pack	1/50/500	
1454/3		Calf Teat Latex	beige		100 mm	1 blister pack	3 / blister pack	1/120	
14230-G	7315-5305-800	Hygienic Valve						1/100	
14224/5-G	7315-5152-000	Butterfly Valve for hygienic valve				1 pouch	5 / pouch	1	



IPCam – incredibly simple installation thanks to 'plug & view': Connect the camera to the network and enable on your smartphone, tablet or PC. Now several users can access the live image on their smartphone, PC or tablet. Suitable for use in networks or the internet. Internet access via cable or wireless is essential! This means you can enjoy live images in under a minute.

IPCam 360 FHD

with 4x optical zoom

- the new hinge can pivot 90 ° and be fixed in place at any point: Ideal positioning on walls, slopes and ceilings for true all-round visibility
- quick swivelling outdoor IP camera with huge field of view (Pan / Tilt / Zoom): swivels horizontally by 355° and vertically by 90°
- excellent image quality with 2 megapixels
- weatherproof aluminium housing
- bright 4x zoom optics
- 30 metre night vision via 6 infrared LEDs
- WDR support (wide dynamic range) for a balanced image of both brighter as well as darker image areas
- remote control and access worldwide via app or browser, immediate connection using the app via a QR code
- WiFi-compatible and ONVIF compliant: compatibility according to an international standard
- free app (eyecloud) for iOS and Android, available in the AppStore and from Google Play
- Motion detection: automatically starts recording on SD(HC/XC) card, notification via email
- includes operating instructions



New product

NEW

supports ONVIF

Included in delivery: 1 x IPCam 360 FHD, 1 x power pack, 1 x Wi-Fi antenna, 1 x patch cable

Technical data	10809
Zoom	4x optical zoom
Image Sensor	2,7 CMOS
Video resolution supported	Full HD 1080 (1920 x 1080) / HD 720 (1280 x 720) / VGA (640 x 480) / QVGA (320 x 240)
Frame rate	15 fps (HD) / 25 fps (VGA)
Panel	f/1,6
horizontal visible range	355 °
Vertical visible range	90 °
Viewing angle	40 - 120 °
Number of LEDs	6
Night vision range	30 m
Transfer type	LAN / WLAN
Weight	1,9 kg
Voltage	12 V
Power	10 W
Protection class	IP66

Ref. no.	Length	Width	Height		€
10809	33 cm	25 cm	14 cm	1/8	



IPCam 360 FHD mini

- quick swivelling outdoor IP camera • excellent image quality with 2 megapixels • extensive viewing area (pan / tilt / zoom): swivels around 355° horizontally and 90° vertically, adjustable speed • remote control and access worldwide via app or browser, immediate connection using the app via a QR code • WiFi-compatible and ONVIF compliant: compatibility according to an international standard • free app (eyecloud) for iOS and Android, available in the AppStore and from Google Play • Motion detection: automatically starts recording on SD(HC/XC) card, notification via email • Recording to microSD(HC/XC) card up to 128 GB • weatherproof aluminium housing • includes operating instructions

New product

NEW

Included in delivery: 1 x IPCam 360 FHD mini, 1 x 230 Volt power pack, 1 x patch cable, 1 x Wi-Fi antenna

Technical data	10825
Image Sensor	2,7 CMOS
Video resolution supported	Full HD 1080 (1920 x 1080)
Frame rate	15 fps (HD) / 25 fps (VGA)
Night vision range	30 m
Weight	1 kg
Voltage	12 V
Power	10 W
Protection class	IP66

Ref. no.	Length	Width	Height		€
10825	21 cm	21 cm	12,5 cm	1/10	

IPCam 2.0 HD

The internet camera for everyone!

- remote control and access worldwide via app or browser, immediate connection using the app via a QR code • WiFi-compatible and ONVIF compliant: compatibility according to an international standard • free app (eyecloud) for iOS and Android, available in the AppStore and from Google Play • motion detection: recording starts automatically, alarm via e-mail, image upload to FTP server • recording to microSD(HC/XC) card up to 16 GB • weatherproof aluminium housing • includes operating instructions



supports ONVIF

Included in delivery: 1 x IPCam 2.0 HD, 1 x power pack, 1 x Wi-Fi antenna, 1 x patch cable

Technical data	10810
Zoom	Digital zoom
Image Sensor	1/4" CMOS
Video resolution supported	HD 720 (1280 x 720) / VGA (640 x 480) / QVGA (320 x 240)
Frame rate	15 fps (HD) / 25 fps (VGA)
Viewing angle	60 °
Number of LEDs	30
Night vision range	15 m
Antenna reach	50 m
Weight	620 g
Voltage	12 V
Power	10 W
Protection class	IP65

Ref. no.		€
10810	1/10	



Mocall Calving Alarm

The hour before/of birth!

Don't miss another birth! The tried and tested calving alarm by Mocall reliably informs you of an impending birth. You'll have enough time to make all the necessary provisions and notify the vet if required. The newborn calf will be well cared for and receive the vital colostrum dose right after birth. Give help in time and save both cow and calf!

- Attach 3 days before the calculated birthdate
- Alerts approx. one hour before birth via SMS, email or app
- sends to two phone numbers and three e-mail addresses (adjustable)
- free "Breed Manager by Mocall" app for iOS and Android
- Device can be used successively on all animals
- suitable for all cattle breeds (Limousin, Angus, Fleckvieh, Holstein Friesian, Jersey, etc.) thanks to flexibly adjustable ratchet closure
- 30 days battery time
- easy charging via USB interface
- built-in SIM – ready to use
- Data plans etc. included in the service fee – included in the first year after activation
- works worldwide via GSM, even with weak network coverage, and with any mobile phone/smartphone
- Plastic



with USB charging cable



Step by step:

1. Register the device online or by phone
2. Charge the device
3. Switch on and send a test message
4. Open the ratchet fastener
5. Adjust the rubber pad
6. Attach at crotch height
7. Finished!

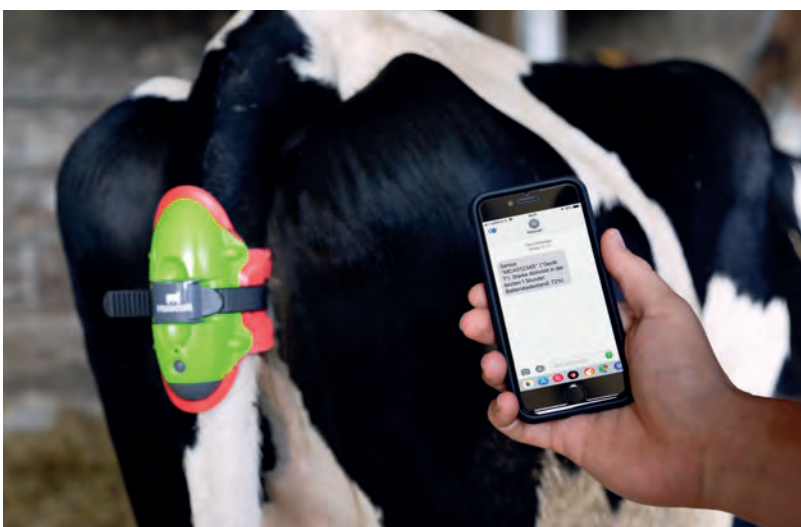

Mocall sends the following messages:

- Sensor has come off the cow's tail
- High activity in the last hour (advance warning)
- High activity in the two hours (birth alarm)
- After 4 days, remove the sensor for 4 hours
- Low battery (20 %)
- Test message

Ref. no.	Colour	Length			€
10500	green / red	19 cm	1/10	220	



Cows and heifers usually give birth without help. But if complications occur during the second stage, mechanical calf pullers are a life-saving aid. Alongside care and expertise, the use of a suitable calf puller is especially important. Otherwise, serious injury or stillbirth could result. An HK calf puller is the right tool to choose. Since Hermann Kaspar developed the HK calf puller more than 50 years ago, more than 1.5 million have been sold.

Made in Germany



3-year guarantee



What makes HK calf pullers unique?

Tie rod

- Stable, thick-walled steel tube, length 180 cm
- A unique, patented groove design gives the mechanism a secure hold
- The tie rod's geometry means the locking plates are applied all over the surface, rather than only at certain points. This improves force transfer and reduces wear
- The rounded edges of the grooves further minimise wear and tear
- The unique machining process lends the tube greater wall thickness and therefore greater stability
- The tube can be disassembled into three parts, for easy storage: HK Rheintech calf pullers are ideal for transporting in cars (e.g. for vets)



HK Plastic Attachment Support - The classic one

sturdy plastic heads with lateral angled clamps

- small, easy to handle, lightweight • ideal for recumbent births where larger heads can often not be positioned under the recumbent cow • 3-year guarantee

HK Plastic Attachment Support with adjustable side clamp

The steel frame is adjusted to the shape of the pelvis, which prevents the ischium and the long ischium muscles from slipping.



- Triple adjustment option means it can be adjusted to each individual animal, i.e. the frame is suitable for both dairy breed with a narrow pelvis and for beef breeds with a wide pelvis • wide, sturdy head for an even more non-slip fit • 3-year guarantee



HK Flexi Frames

The best protection against slipping. The frame surrounds the mother's pelvis and reliably prevents slipping down and to the side.

- tiltable, pulling motion possible both towards the tail and towards the udder • Frame made from galvanised steel tube with a smooth surface, making it both hygienic and easy to clean • 3-year guarantee

Ref. no.	Bowl width	Pipe diameter	Suitable for			€
106820	52 cm	26 mm	Dairy Breeds	1	20	
106821	58 cm	30 mm	Beef Breeds, Cows with wide pelvises	1	20	

Accessories for HK Calf Pullers

Ref. no.	Description	Length	suitable for		€
106908	Extension for HK calf puller	30 cm		1	
106907	Threaded Piece for attaching the extension		106908	1	



HK Calf Pullers with Mechanism 2020

Benefits of the Mechanism 2020

- low weight, as made entirely out of aluminium
- with 3 hooks for the calving ropes enabling both alternate and equal tension
- super easy to use quick release, even under load
- the mechanism can be moved 360° around the tube in all models, providing unlimited flexibility
- 3-year guarantee

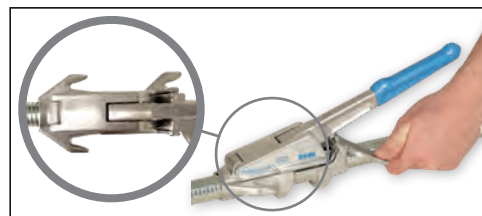



1012

10121

10126

10130,10131

Ref. no.	Description	Bowl width			€
1012	with plastic attachment support		1	50	
10121	with plastic attachment support and lateral angled clamps		1	50	
10126	with large plastic head and adjustable side clamp	49 - 63 cm	1	30	
10130	with HK Flexi Frames	52 cm	1	50	
10131	with HK Flexi Frames	58 cm	1	16	

HK Calf Pullers with Mechanism 2060

The tension limiter prevents pulling the calf with too much force. Without regulation, tensile forces of up to 600 kg can be achieved, representing a substantial risk of injury to the cow and calf. For normal births, forces of up to 160 kg are entirely sufficient. The HK Rheintechnik Mechanism 2060 is fitted with a freely adjustable tension control. The lever locks when the pre-set force is attained. The tension control can also be released in an emergency.

- low weight, as made entirely out of aluminium
- with 2 hooks for the calving ropes (equal tension)
- super easy to use quick release, even under load
- the mechanism can be moved 360° around the tube in all models, providing unlimited flexibility
- 3-year guarantee

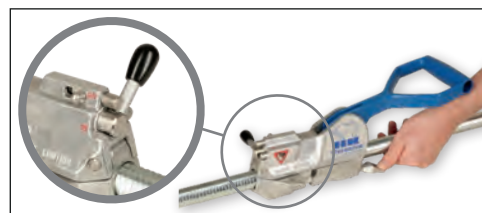



Adjustable tension limiter



102060

10140,10141

Ref. no.	Description	Bowl width			€
102060	with large plastic head and steel clamps	49 - 63 cm	1	30	
10140	with HK Flexi Frames	52 cm	1	48	
10141	with HK Flexi Frames	58 cm	1	16	

Spare Cord for HK calf puller

- does not absorb blood and does not become rigid • Material: PPMF • 3-strand • twisted • in pairs

PPMF only absorbs a maximum of 0.1 % moisture instead of 10 %, unlike the polyamide previously used. This means it doesn't shrink when drying, becomes rigid less rapidly and is longer lasting. The rope also absorbs hardly any blood and stays hygienic white.

Ref. no.	Colour	Length		€
103	white	80 cm	1/100	
103/1	white	80 cm	1	

Vink SECURPART Calf Puller

- Downwards, upwards and rearwards tensile force possible • sturdy and durable design
- the tension can be eased immediately in case of complications • Traction type: Equal Traction • stainless steel



Ref. no.	Length		€
1045	160 cm	1	
1046	180 cm	1	

Ref. no.	Description	packaged	suitable for		€
10451	Calving Cord for calf puller in pairs	in pairs	1045, 1046	1/200	

Vink SECURPART Calf Puller Modell A 800 Bayern

This birth aid can allow a single person to carry out difficult births, even if the foetus is the wrong way round. The strap goes around the hind quarters of the animal and prevents slipping off - suitable for all breeds. Tensile forces can be applied to all sides (bottom, top, back) and the tensile force can be released immediately in the event of complications. If required, the user can have both hands free.

- suitable for prone and standing births • with lever action for alternating tension • wear-resistant and made from non-rusting steel • Traction type: Alternate traction

Ref. no.	Length	Suitable for			€
1047	180 cm	Beef Breeds	1	13	

Ref. no.	Description	packaged	suitable for		€
10488	Calving Cord for calf puller in pairs	in pairs	1047	1/200	

Calving Cord

- 2 eyelets • Material: PPMF • flat braided
- per piece

Ref. no.	Colour	Length	MOQ	Pieces / unit		€
1036	white	125 cm			1/10/420	
1036/1	white	125 cm	1 blister pack	1 / blister pack	1	
1025	white	190 cm			1/100	

Calving Cord

- 2 eyelets • flat braided for gentle birth • soft quality • per piece

Ref. no.	Colour	Length		€
10259	yellow / red	130 cm	1/25/350	

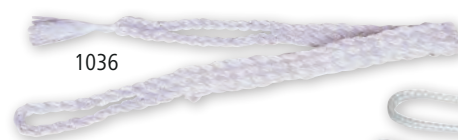
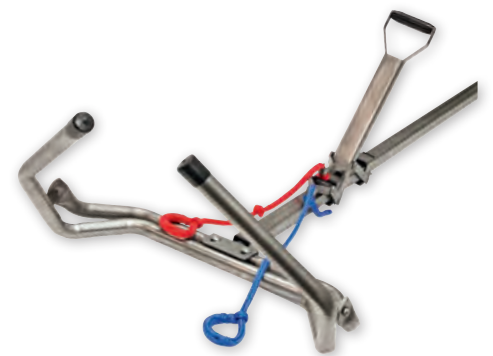

Pregnancy Tester for cows

- avoid unpleasant surprises such as false pregnancy or missed abortions thanks to fast, simple and reliable pregnancy detection from 90 days after insemination using sonar
- no previous expertise or training required
- in most cases, the test takes less than 30 seconds
- no unpleasant transrectal examination required for the animal and no risk at all
- the device is comfortably worn on the belt, leaving both hands free for measurement
- Supplied in a solid plastic case

Ref. no.		€
1060	1/10	



Estrus Detection for cattle

- for determining the optimum mating or insemination time
- the device monitors changes in the characteristics of vaginal discharge during the ovulation cycle by measuring its electrical resistance. The breeder is then able to determine the exact time of ovulation.
- it can also be used to confirm an early pregnancy from the 19th to the 23rd day after insemination.
- insemination or impregnation at the optimum time during estrus saves precious semen.
- reduction of the period of time between giving birth and the next pregnancy
- operated with: 1 x 9 V - Block PP3 Alkaline

Ref. no.		€
10250	1/10	

We recommend taking a reading once or twice a day over a period of a few consecutive days.



The first few minutes are decisive! The calf comes hind legs first or stays in the birth canal for too long. Breathing does not start, birth mucus closes the airways. Now is the time to act quickly! The calf is often pulled up by its hind legs or hung over the closest fence to enable the mucus to flow out of the airways. But the opposite actually happens: The calf has even more trouble breathing as its internal organs press against its lungs and bronchi. Using a resuscitator, colloquially known as a 'calf saver', is much easier on the farmer's back and also far more effective.

HK Calf Resuscitator according to Dr. Bron

The HK Rheintech calf resuscitator looks like a large air pump. The suction cup is placed over the calf's nose and mouth. 1. Mucus is removed from the respiratory tract in one powerful stroke. 2. The mucus is expelled from the pump, then air is pumped into the airways. The lung's lobes and alveoli can unfold. This process can be repeated several times until the calf starts breathing by itself.



Advantages:

- Especially sturdy: The metal cylinder is shock-resistant, the hard plastic suction cup with rubber lip is also practically indestructible. This makes the Dr Bron calf resuscitator perfect for quick use in emergency situations.
- Easy handling
- Can also be used by a single person



Ref. no.		€
1032	1	

3-year guarantee



Lubricating Gel VetGel

• lubricating gel to make hands and arms slippery and an excellent skin protection during rectal and vaginal examinations • sperm-friendly



Top Seller



Recommended by veterinarians!

Ref. no.	Contents			€
1027	1000 ml / Bottle	1/6	378	
10272	5000 ml / Canister	1	84	

HK Lubricating Gel

• covers the skin with an optimal lubricating layer • for all types of veterinary medical examinations • ideally suited for hands, arms, gloves and instruments • optimal pH value to maintain sperm quality



Top Quality



Ref. no.	Contents			€
10266	1000 ml / Bottle	1/10	600	
10267	5000 ml / Canister	1/4	192	

Veterinary disposable gloves VETtop with shoulder protection

• ideal for veterinaries • self-adhesive • very sensitive • for single-use only • food safe



Ref. no.	Colour	Size	Length	Material thickness	MOQ	Pieces / unit			€
15376	green transparent	unysize	120 cm	25 micron = 0,025 mm	1 pack	50 / pack	1/10	360	

Veterinary disposable gloves VETtop

• ideal for veterinaries • tearproof • very sensitive • for single-use only • food safe



Ref. no.	Colour	Size	Length	Material thickness	MOQ	Pieces / unit			€
1536	transparent	unysize	90 cm	28 micron = 0,028 mm	1 pack	100 / pack	1/15	360	

Veterinary disposable gloves VETbasic

• multi-purpose: for farmers, veterinarians but also suitable for use as a refuelling glove • for single-use only • food safe



Ref. no.	Colour	Size	Length	Material thickness	MOQ	Pieces / unit			€
15364	orange	unysize	90 cm	25 micron = 0,025 mm	1 pack	100 / pack	1/15	360	



Cattle Hobble with padding

- particularly animal-friendly padding • swivel to prevent chain tangling • prevents injuries
- helps cows get up after giving birth • Material: Polyester



Ref. no.	Leg distance		€
10284	40 cm	1/10/30	

Cattle Hobble Top-Qualität

- increased tensile and tear resistance through special braiding method • extra-thick strap material for maximum load • helps cows get up after giving birth



Made in Germany



recommended by professional associations in Germany!

Ref. no.	Leg distance		€
10291	40 cm	1/10	
10292	22 - 42 cm	1/10	

Cattle Hobble Standard

- helps cows get up after giving birth • prevents injuries • Material: Nylon

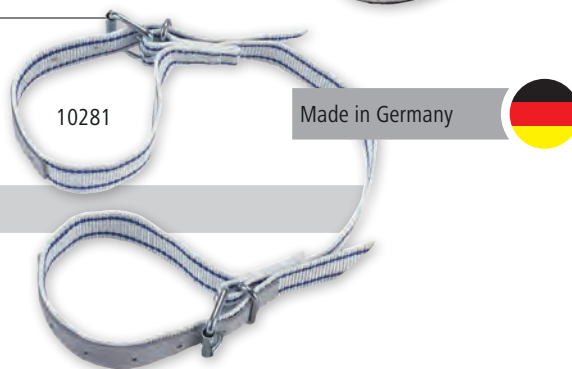

Made in Germany





recommended by professional associations in Germany!

Ref. no.	Leg distance		€
10281	40 cm	1/10	
10282	20 - 42 cm	1/10	

Prolapse Bandage

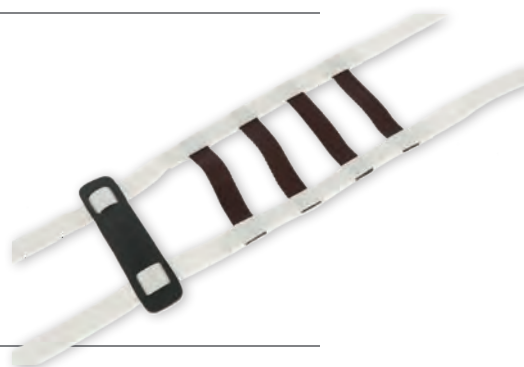
- prevents a prolapse from escalating and becoming chronic • Material: Nylon



Ref. no.		€
1031	1/20	

Cow Blanket for mature cattle

- warm, well-fitting blanket for ill and downer cows • can also be used for protection during exhibitions • outer materials made from tear-resistant 600 denier ribstop polyester • with soft, flexible, adjustable leg straps to the front and back • extremely water-resistant up to a 3000 mm water column • 3000 g/m²/24 h (air permeability)
- machine washable at 30 °C





Ref. no.	Colour	Width	Total length		€
1545	grey	140 cm	145 cm	1/6	
1546	grey	140 cm	155 cm	1/6	
1548	grey	140 cm	175 cm	1/6	

Cow Lifting Frame Profi for cows

- very robust and stable design - has been proving itself for decades • an indispensable tool for cows that can not stand on their own (e.g. difficult birth) • a sensible investment that quickly pays for itself and should be a must for every dairy farmer • the rubberised grip clamps can be adjusted to the size of the cow • any animal can be raised with the help of a pulley or other device • Material: metal



The best professional device!

Ref. no.	Colour	Suitable for	permissible animal weight			€
1067	green	small to medium breeds of cattle	900 kg	1	24	
1068	green	large cattle breeds, Beef Cattle	1.500 kg	1	8	

Cow Lifting Frame Standard for cows

- inexpensive lifting device for cows in the standard version • for standing up downer cows • clamps are infinitely adjustable to the specific bowl width • any animal can be raised with the help of a pulley or other device • Material: metal





Ref. no.	Colour	Suitable for	permissible animal weight			€
1057	green	small to medium breeds of cattle	800 kg	1	42	

Cow Lifting Device

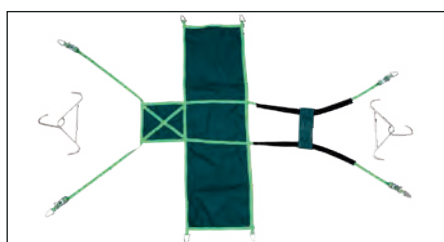
- developed for short to medium term support of weak cows • helps the cow regain full mobility • promotes blood circulation • the bib increases the load surface and supports the animal when lifting • significantly fewer pressure points thanks to the wide surface area • robust tearproof PVC material • padding to the belts in the udder area prevents chafing wounds • robust belts with adjustable ratchets enable the belt length to be adjusted even under load • all metal parts are galvanised • can be adjusted to different sizes • comes as a complete set in a carrying case



Ref. no.	Colour	permissible animal weight			€
1066	green	1.000 kg	1/2	42	

ColostroStart

Colostrum management

The feeding of calves during the first days of life or even immediately after birth is crucial for their further development. First milk, also known as colostrum, has a higher percentage of immunoglobulins and nutrients than normal cow's milk. Consequently, the new-born calf needs to take in higher quantities of the high-quality colostrum straight away. It is recommended that a colostrum store be created with frozen colostrum. This means that there is always a stock of high-quality first milk available. If the quality of the colostrum after birth is poor (e.g. in heifers) or the amount produced is too low, frozen colostrum can be used instead. The products in our ColostroStart Colostrum Management System are the best way to help you to provide your new-born calves with colostrum. The aluminium pouches (4 litre) are easy to fill and can be pasteurised (optional), frozen and reheated without any problems. To administer the colostrum, simply screw on the drinking teat or drencher probe.

We have put together retail sets geared towards your needs:

14640: ColostroStartSET 10

- 10 colostrum bags • 1 teat • 1 drencher probe

14641: ColostroStartSET 50

- 50 colostrum bags • 3 teats • 3 drencher probes

To make filling the pouches even easier, we offer the ColostroFILLER filling tool. The optional ColostroCASE drinks trough bag keeps the first milk warm for longer, making feeding easier.



TV

How it works:

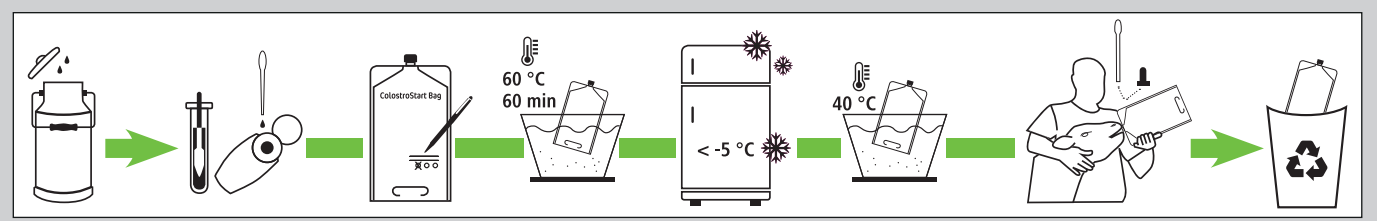

14646



14644

14648



14647

Ref. no.	Description			€
14640	ColostroStart Set 10	1	45	
14641	ColostroStart Set 50	1	16	

Ref. no.	Description	MOQ	Pieces / unit		€
14642	ColostroStartBAG	1 pack	5 / pack	1/20	
14644	Teat with union nut			1	
14648	Probe with screw fastener			1	
14646	Drinks Trough Bag ColostroCASE			1/50	
14647	Filling Aid ColostroFILLER			1	

Refractometer

Colostrum measuring device

- for the accurate and rapid determination of colostrum milk quality
- the quality level of the colostrum can be quickly ascertained with impressive accuracy with just one look through the lens
- suitable for cow and horse colostrum
- packaged in high-quality case



Included in delivery: 1 x refractometer, 1 x pipette, 1 x screwdriver, 1 x cloth, 1 x bag

Ref. no.		€
1464	1/40	

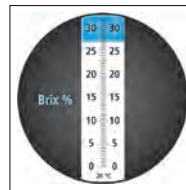

Colostrometer

Colostrum measuring device

- for the quick and easy determination of colostrum quality
- it measures the gamma globulin content via the specific density
- colostrum quality can be read off from the colour scale on the spindle





Ref. no.		€
1459	1/100	

Calf Feeding Bucket

- complete with Super-Teat and screw valve
- Easy to clean
- if necessary mounting bracket item no. 1410
- Material: Plastic
- food safe
- with metal carry handle
- acid-proof
- with embossed measuring scale



Available in customer-specific composition.
Note the instructions at the end of the catalogue.

Ref. no.	Colour	Capacity	MOQ	Pieces / unit			€
144	grey	8 L	5 pieces	5 / pack	1/5	240	

Feeding Buckets, Teats and Bottles

Calf Bucket with FixClip New Generation valve

The FixClip valve breaks completely new ground with the patented clamp closure, making removal and installation, as well as the cleaning of the valve and teat, easier and quicker than ever before.

- Easy to clean • food safe • with metal carry handle • acid-proof • with printed fill scale on the back, with additional embossed scale on the inside

New generation –The completely modified shape guarantees a secure fit for the clip and valve body. The additional extension on the back of the clip, in particular, makes it easier to use, because it fastens the clip to the bucket and ensures a secure fitting while calves drink.

The advantages are obvious:

- minimal bacterial contamination and therefore healthier calves
- minimal time required for changing and cleaning the valve

New product

NEW



Ref. no.	Description	Colour	Capacity	MOQ	Pieces / unit			€
14235	with natural rubber teat	white transparent	8 L	5 pieces	5 / pack	1/5	180	

Valve FixClip New Generation

The hygienic feeding bucket valve with the patented clip fastener!

New generation –The completely modified shape guarantees a secure fit for the clip and valve body. The additional extension on the back of the clip, in particular, makes it easier to use, because it fastens the clip to the bucket and ensures a secure fitting while calves drink.

It is assembled and dismantled in seconds, and the feeding bucket valve can be thoroughly cleaned with a brush. This ensures a high level of hygiene during feeding.

The FixClip valve has only three parts:

- Valve body (a) with straight intake supports, making it easier to access for cleaning
- Removable valve flap (b)
- Clip (c) for fixing the teat and valve body to the feeding bucket

The FixClip valve is suitable for all conventional feeding buckets with a hole opening of 36 – 38 mm, but is only usable with the specially developed Vital Teats (item no. 14248/5), Super Teats (14249/5) and natural rubber teats (14251/5).

New product

NEW

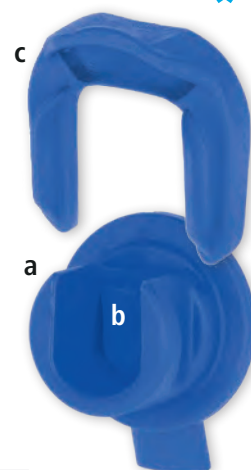

Ref. no.	Description	Colour	MOQ	Pieces / unit		€
14236	single	blue	5 pieces	5 / pouch	1	
14237	with natural rubber teat	blue			1/25	
14237/2	with natural rubber teat		1 blister pack	2 / blister pack	1	
14238/2	with Super Teat		1 blister pack	2 / blister pack	1	
14239/2	with Vital Teat		1 blister pack	2 / blister pack	1	

Ref. no.	Description	MOQ	Pieces / unit		€
142363/5	Butterfly Valve for FixClip Valve	1 pouch	5 / pouch	1	

Teat for FixClip Valve

Vital Teat:

- promotes natural suckling behaviour • the desire to suckle is better satisfied through slow and relatively difficult suckling • increases saliva production and therefore promotes digestion

Super Teat:

- the proven standard teat

Natural rubber teat:

- especially suitable for young calves



14248/5



14249/5



14251/5

Ref. no.	Description	Colour	MOQ	Pieces / unit		€
14248/5	Vital Teat	black	1 pack	5 / pack	1/10/100	
14249/5	Super-Teat	red	1 pack	5 / pack	1/10/100	
14251/5	Natural rubber teat	beige	1 pack	5 / pack	1/10/100	

Screw Valve

Ref. no.	Description	Colour	can be used for	MOQ	Pieces / unit		€
14276	149 and Super Teat 147	grey	for all Kerbl feeding buckets			1/50	
1490/2	149 and Super Teat 147	grey	for all Kerbl feeding buckets	1 blister pack	2 / blister pack	1/50	
14277	149 and Latex Teat 1454	grey	for all Kerbl feeding buckets			1/50	
149	complete	grey	for all Kerbl feeding buckets	10 pieces	10 / pack	1/10	
149/2	complete	grey	for all Kerbl feeding buckets	1 blister pack	2 / blister pack	1/100	

sealing ring for feeding buckets

Ref. no.	Description	Colour	Thickness	can be used for	MOQ	Pieces / unit		€
148	Standard	red	3 mm	Screw valve 149	50 pieces	50 / pouch	1/50/5.000	
148/5	Standard	red	3 mm	Screw valve 149	1 blister pack	5 / blister pack	1/100	
1480	Standard	blue	4 mm	Galvanised feeding bucket	50 pieces	50 / pouch	1/50/2.500	
1480/5	Standard	blue	4 mm	Galvanised feeding bucket	1 blister pack	5 / blister pack	1	
1489	HIKO	red	2,5 mm	Screw valve 149	50 pieces	50 / pouch	1/50	
1489/5	HIKO	red	2,5 mm	Screw valve 149	1 blister pack	5 / blister pack	1	

Cover for Feeding Bucket

Cover for 13 L bucket: Dirt, rain water and flies can not get into the bucket. The feeding bucket and cover are easy to hang on the mounting brackets.

Cover, single: Keeps dirt out of the bucket interior. A feeding bucket with an attached cover can be mounted to calf house fences and retrofitted mounting brackets. Available in several colours.

Cover MilkGuard: Flies, dirt and rainwater cannot get into the bucket interior thanks to the completely closed cover, ensuring a high standard of hygiene. Feeding buckets with an attached cover can be easily attached to mounting brackets.



14211

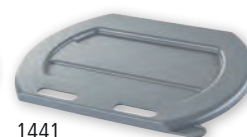

1441



14273



14272

Ref. no.	Description	Colour	can be used for		€
1441	simply	grey	for all Kerbl feeding buckets	1/50	
14211	simply	green	for all Kerbl feeding buckets	1/50	
14272	MilkGuard	white transparent	for all Kerbl feeding buckets	1/50	
14273	13 l	white transparent	14284 Feeding Bucket 13 L	1/76	

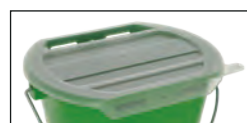

NEW

Mounting Bracket

- suitable for all feeding buckets

1408: Thanks to the bucket safety catch, the feeding bucket stays in position when being drunk from and cannot be pushed back.

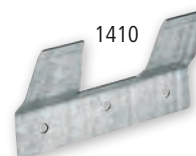

- Also suitable for mounting on calf house fences.



1410



1408

Ref. no.	Description	Material	MOQ	Pieces / unit			€
1408	with bucket safety catch	metal galvanised			1/50	900	
1410	simply	metal galvanised	10 pieces	10 / pack	1/10/150	6.000	
1410/2	simply	metal galvanised	1 blister pack	2 / blister pack	1	1.800	

Catch Bucket Guard

The catch ensures that the animal cannot toss the feeding bucket out of the bucket holder. Also suitable for mounting on calf house fences.

- suitable for all feeding buckets

1406: Can be retrofitted to existing mounting brackets (item nos. 1408, 1410).

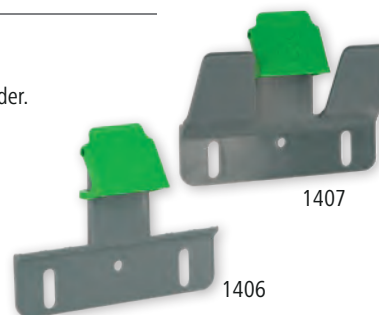

1407: the feeding bucket can be hung directly in it



1406

1407



Ref. no.	Description	Material	MOQ	Pieces / unit			€
1406	retrofitable	Plastic	1 pack	3 / pack	1/3/60	1.800	
1407	with bucket holder	Plastic	1 pack	3 / pack	1/3/60	1.800	

NEW

Feeding Buckets, Teats and Bottles

Calf Feeder Tray Multi Feeder

No portioning

- for the simultaneous provision of drinks to up to 5 calves • makes animal surveillance easier during milk feeding • without portioning and with rounded corners, thus very easy to clean • for hanging on barn walls, feed barriers, fences, etc. (pipes up to max. Ø 61 mm (2")) • with an easy to use rotary snap closure for attaching and securing to the tray • ideally suited to the large-area Calf House (item nos. 14440, 14520, 14540) • stackable • easy to transport • not suitable for sanitary valves (ref. 14220/2, Art. 14230) and FixClip Valves • food safe • chemical-resistant



Ref. no.	Description	Colour	Capacity	Length	Width	Height			€
14218	with 5 valves (149) and 5 Super Teats (147)	green	30 L	70 cm	35,4 cm	27,8 cm	1	57	
14201	with 5 valves (149) and 5 latex teats (1454)	green	30 L	70 cm	35,4 cm	27,8 cm	1	57	
14202	with 5 Big Softy Teats (14141)	green	30 L	70 cm	35,4 cm	27,8 cm	1	57	
14215	single, with large openings for Super and Latex Teats	green	30 L	70 cm	35,4 cm	27,8 cm	1	57	
14203	single, with small openings for Big Softy Teats	green	30 L	70 cm	35,4 cm	27,8 cm	1	57	

Ref. no.	Description	Colour	Length	MOQ	Pieces / unit		€
14910/5	Screw Valve 149 and Super Teat 147	grey		1 pack	5 / pack	1	
14915/5	Screw Valve 149 and Latex Teat 1454	grey		1 pouch	5 / pouch	1	
14141/5	Teat Big Softy	black	100 mm	1 blister pack	5 / blister pack	1	
14890/5	sealing ring	white		1 pack	5 / pack	1	
14142	Corner for Big Softy and Little Softy teats with valve	orange		1 pack	10 / pack	1	
14144	Corner for Big Softy and Little Softy teats without valve	white		1 pack	10 / pack	1	
14214	Cover for Multi Feeder	black				1/100	

Drinking Trough Multi Feeder

with portioning

- with 5 portion compartments for the simultaneous provision of drinks to up to 5 calves • makes animal surveillance easier during milk feeding • Volume per portion compartment: 3 litres • with rounded corners, thus very easy to clean • for hanging on barn walls, feed barriers, fences, etc. • easy mounting and securing of the trough thanks to elastic straps • stackable • easy to transport • acid-proof • only suitable for Big Softy Teats • ideally suited to the large-area Calf House (item nos. 14440, 14520, 14540) • food safe



Ref. no.	Description	Colour	Capacity	Length	Width	Height			€
14204	with Big Softy Teats	green	30 L	81 cm	43 cm	38 cm	1	48	
14205	without teat	green	30 L	81 cm	43 cm	38 cm	1	48	

Ref. no.	Description	Colour	Length	MOQ	Pieces / unit		€
14141/5	Teat Big Softy	black	100 mm	1 blister pack	5 / blister pack	1	
14142	Corner for Big Softy and Little Softy teats with valve	orange		1 pack	10 / pack	1	
14144	Corner for Big Softy and Little Softy teats without valve	white		1 pack	10 / pack	1	
14214	Cover for Multi Feeder	black				1/100	

Feeding Buckets, Teats and Bottles

Calf Teat

• for calf drinking bucket • x-pierced



correct installation



incorrect installation



Ref. no.	Description	Colour	Length	MOQ	Pieces / unit		€
145	Standard	yellow	100 mm	50 pieces	50 / pack	1/50/500	
145/3	Standard	yellow	100 mm	1 blister pack	3 / blister pack	1/120	
146	Standard	yellow	125 mm	50 pieces	50 / pack	1/50/500	
146/3	Standard	yellow	125 mm	1 blister pack	3 / blister pack	1/120	
147	Super	red	100 mm	50 pieces	50 / pack	1/50/500	
147/3	Super	red	100 mm	1 blister pack	3 / blister pack	1/120	
1471	Super	red	125 mm	50 pieces	50 / pack	1/50/500	
1471/3	Super	red	125 mm	1 blister pack	3 / blister pack	1/120	
1453	Calves	white	100 mm	50 pieces	50 / pack	1/50/500	
1453/3	Calves	white	100 mm	1 blister pack	3 / blister pack	1/120	
1454	Latex	beige	100 mm	50 pieces	50 / pack	1/50/500	
1454/3	Latex	beige	100 mm	1 blister pack	3 / blister pack	1/120	
1477	Rubber	honey	100 mm	50 pieces	50 / pack	1/50/500	
1477/3	Rubber	honey	100 mm	1 blister pack	3 / blister pack	1/120	

Teat

• for automatic drinkers • with round holes



round holes



Ref. no.	Description	Colour	Length	MOQ	Pieces / unit		€
1472	Standard	white	100 mm	50 pieces	50 / pack	1/50/500	
1472/3	Standard	white	100 mm	1 blister pack	3 / blister pack	1/120	
1474	Super	red	100 mm	50 pieces	50 / pack	1/50/500	
1474/3	Super	red	100 mm	1 blister pack	3 / blister pack	1	
1478	Rubber	honey	100 mm			1/50/500	

Teat Big Softy

• replacement teat for Calf Drinking Tray Multi Feeder, Double Calf Drinking Trough MILK TRAIN and Calf Drinking Trough MILK BAR



Ref. no.	Colour	Length	MOQ	Pieces / unit		€
14141	black	100 mm			1/25/450	
14141/5	black	100 mm	1 blister pack	5 / blister pack	1	



Calf Teat MilkyTeat

• with integrated flap valve for easy drinking • Spare teat for application with calf bottles • suitable for SpeedyFeeder and MilkyFeeder

Ref. no.	Colour	MOQ	Pieces / unit		€
14672	grey	1 pouch	10 / pouch	1/30	



New product

NEW



Feeding Buckets, Teats and Bottles

Aluminium calf feeder valve with teat

- extremely quick opening using a bayonet joint makes the item very hygienic and easy to clean



Ref. no.	MOQ	Pieces / unit		€
1415			1/20	
1415/2	1 blister pack	2 / blister pack	1/50	

Ref. no.	Description	MOQ	Pieces / unit		€
1419	Teat for Aluminium calf drinker valve	20 pieces	20 / pack	1/20/200	
1419/3	Teat for Aluminium calf drinker valve	1 blister pack	3 / blister pack	1/50	

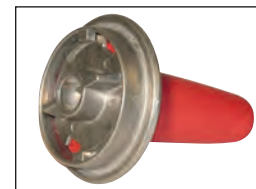

Floating Suction Cup

- easy to take apart and clean
- the extra-large float means the teat can no longer be tipped
- with break-proof mounting tab
- with round holes

Ref. no.		€
1416	1/100	

Ref. no.	Description		€
1417	Teat for floating teat	1/50/400	



Teat Leimer

- tried and tested for years!
- with round holes

Ref. no.		€
1412	1/100	



1412

Bottle Teat

- Material: Rubber
- food safe

Ref. no.		€
14191	1/50/500	





14191

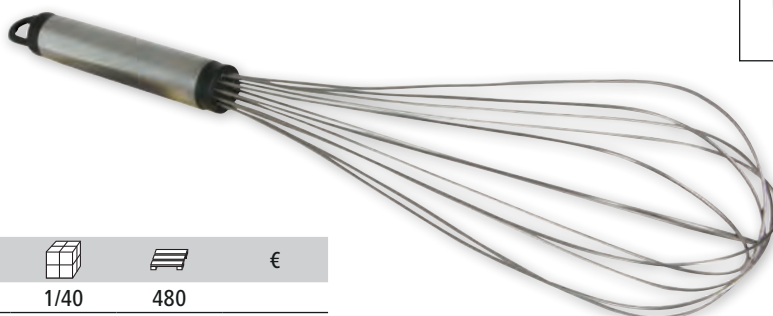

Snow Broom Nirosta

- ideal for stirring the calf milk in the bucket
- with 6 wire loops



Ref. no.	Material	Length			€
14135	stainless steel	40 cm	1/40	480	

Calf Bottle MilkyFeeder

- with 3-stage valve for adjustment of the drinking speed
- easy-to-clean due to the large bottle opening
- teat with integrated flap valve for easy drinking
- with screw fastener
- 14677: Teat with cover, also suitable for 1422 and 1487
- with measuring scale (in l, qt.)



Ref. no.	Capacity			€
14676	4 L	1/12	144	

Ref. no.	Description		€
14677	Teat with lid	1/250	

Milk Bottle

- suitable for single animal breeding and for drug administration
- complete with teat
- with measuring scale



Ref. no.	Description	Capacity			€
1425	round	1 L	1/20	320	
1426	angular	2 L	1/20	160	
1461	square, with handle	3 L	1/40	320	

Milk Bottle

- with milk teat 1432
- can also be used with the drench probe (item no. 14682, 14683)
- for milk portions as well as liquid therapy and electrolyte treatment of calves
- large filler hole with screw cap
- external grip without cavities making it easy to clean and prevent nucleating deposits
- Material: Plastic
- food safe
- with measuring scale



Ref. no.	Capacity			€
14255	2,5 L	1/10	260	
14257	4 L	1/10	160	

Ref. no.	Description	suitable for		€
1432	Milk Teat for milk bottle		1/25/300	
14256	Metal Holder	14255	1/10	
14258	Metal Holder	14257	1/10	

Feeding Buckets, Teats and Bottles

Calf Bottle Speedy Feeder

- drinking bottle with 3-way valve • ergonomic bi-directional handle • Bottle neck with a large (70 mm) diameter • Screw cap with large bottle opening
- revolutionary „pump“ teat • large base ensures high stability



All covers fit all Speedy Feeders (blue), Speedy Drencher (red) and Big Drencher (green).



Ref. no.	Capacity			€
1422	2,5 L	1/20	240	
1487	4 L	1/12	144	

Ref. no.	Description		€
1423	Teat with lid	1/250	

Calf Drencher MilkyDrencher

- with 3-stage valve for adjustment of the drinking speed • easy-to-clean due to the large bottle opening
- with moveable probe attachment • with screw fastener
- 14675: Probe with cover, also suitable for 1479 and 1488 • with measuring scale (in l, qt.)

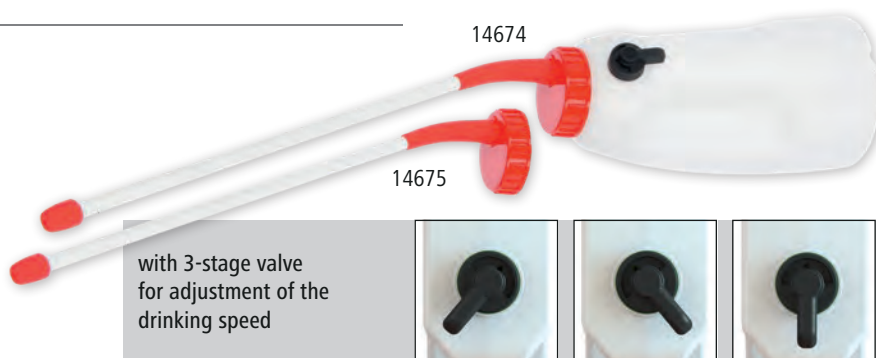

Ref. no.	Capacity	Probe length			€
14674	4 L	52 cm	1/12	96	

Ref. no.	Description	Probe length		€
14675	Probe fixed with cover	52 cm	1/80	

Calf Drencher Profi

- for liquid therapy and electrolyte treatment of calves • with screw fastener
- with measuring scale



Ref. no.	Description	Capacity	Probe length			€
14692	with flexible probe	2 L	105 cm	1/10	120	
14693	with fixed probe	2 L	48 cm	1/10	120	
14695	with flexible probe	4 L	105 cm	1/10	120	

Ref. no.	Description	Probe length		€
14698	Probe flexible with screw cap	105 cm	1/50	
14699	Probe fixed with a screw cap	48 cm	1/50	

Speedy Drencher

- drinking bottle with 3-way valve • ergonomic bi-directional handle • Screw cap with large bottle opening • large base ensures high stability



All covers fit all Speedy Feeders (blue), Speedy Drencher (red) and Big Drencher (green).

TV

Ref. no.	Capacity	Probe length			€
1479	2,5 L	48 cm	1/20	160	
1488	4 L	48 cm	1/12	96	

Ref. no.	Description	Probe length		€
1483	Probe fixed with cover	48 cm	1/80	

Drench Bag

- transparent feed pouch for liquid therapy and electrolyte treatment of calves • with zip closure for easy filling and cleaning • with flexible probe incl. tube • with tube clamp to regulate drinking speed and to close the tube • with embossed measuring scale



Ref. no.	Capacity	Probe length			€
14678	2,5 L	152 cm	1/30	300	





Feeding Buckets, Teats and Bottles

Syringe Drencher

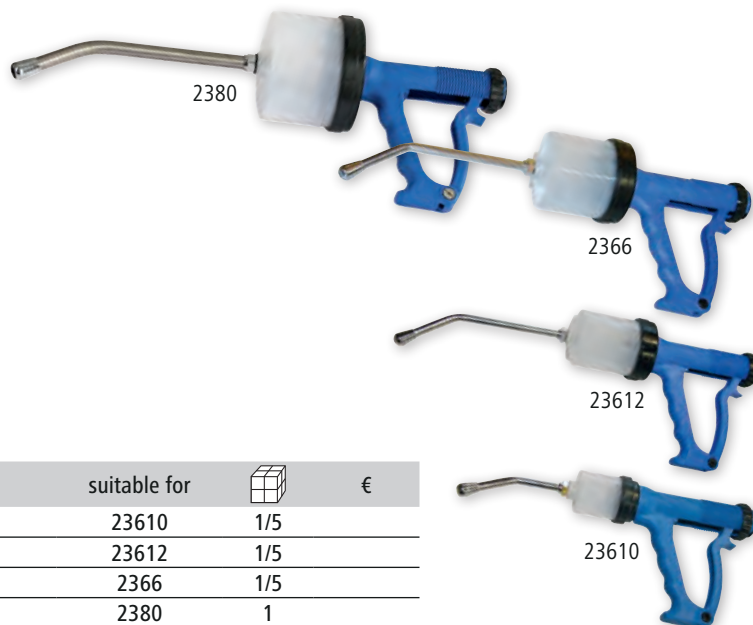
• manual design • light and unbreakable • easy to take apart and clean • Dosage settings: steplessly adjustable using the setting wheel



Ref. no.	Capacity		€
23610	70 ml	1/50	
23612	200 ml	1/20	
2366	300 ml	1/20	
2380	500 ml	1/10	

Ref. no.	Description	suitable for		€
23616	sealing ring for drencher	23610	1/5	
23618	sealing ring for drencher	23612	1/5	
23615	sealing ring for drencher	2366	1/5	
23619	sealing ring for drencher	2380	1	



Drencher

• the ideal filler bottle for livestock • wide opening (70 mm) for easy filling with dry or liquid foodstuff • 12 cm long feeder unit



All covers fit all Speedy Feeders (blue), Speedy Drencher (red) and Big Drencher (green).



Ref. no.	Description	Capacity	Probe length			€
1424	Easy Drencher	1,2 L	12 cm	1/30	540	
1484	Big Drencher	2,5 L	12 cm	1/20	240	

Ref. no.	Description	Probe length		€
14102	Probe for Big Drencher	12 cm	1	

Dry Food Bottle

• complete with teat and plastic holder • developed for calf rearing feed, which can be given from the 2nd day for approx. 3 months and greatly promotes the development of the rumen • the future output (milk production) of the animal is thus increased, and the utilisation of feed is significantly improved

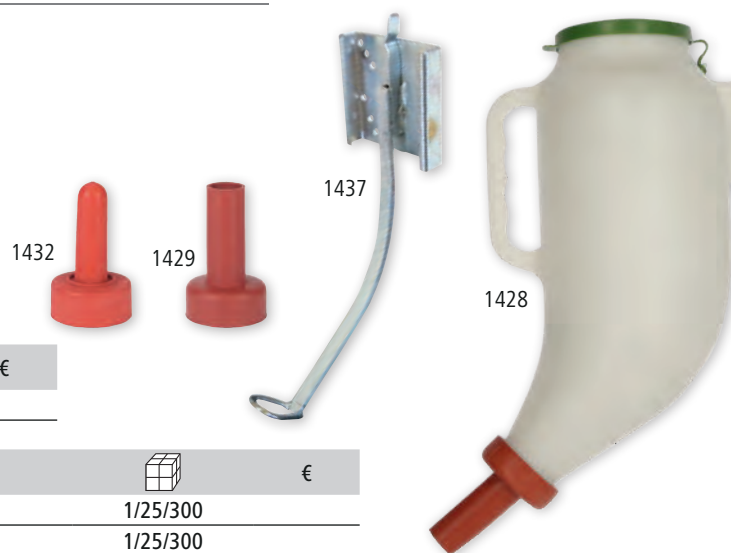

Ref. no.	Capacity			€
1428	4 L	1/20	180	

Ref. no.	Description		€
1429	Teat for dry food bottle	1/25/300	
1432	Milk Teat for milk bottle	1/25/300	
1437	Metal Holder	1/6	

Milk warmer MilkPot 50

Specialist literature and studies indicate that the feeding of young calves has a marked effect on animal health, development and therefore the later performance of the animal. To achieve positive results, an in-depth knowledge on the part of the farmer and technical equipment are usually required. Our milk warmer provides the ideal support for calf rearing, especially for medium-sized operations. It closes the gap between immersion heaters and mobile milk tanks with elaborate equipment. Quickly and without much effort, up to 50 litres of milk or milk substitute mixture can be heated up. The milk is heated using a water bath gently and without causing it to scorch. The milk warmer is also ideal for pasteurising milk.

Stirrer optionally available!

The powerful optional stirrer ensures clump-free stirring of milk substitute. By briefly switching the mixer on while fresh milk is heating, the heating time can be shortened. The cover with integrated mixer can easily be placed on the MilkPot 50 (Art. 141450) and screwed into position.

- 1,000 rpm
- 370 W
- ready to connect



Technical data	141450
Capacity	50 L
Voltage	230 V AC
Mains frequency	50 Hz
Temperature control range up to	0 - 100 °C
Weight	32 kg
Connecting Cable	

- made from food-grade stainless steel
- easy cleaning thanks to the lid which can be fully opened
- with volume scale inside the tank
- water bath: separate inlet and outlet, viewing window to check fill levels
- stepless thermostat
- pasteurisation possible
- 1" outlet with slider valve from the food industry
- with rod thermometer (food-safe)
- incl. lid

Item no. 141461

Cover with stirrer



Item no. 141450

MilkPot 50

Item no. 141462

Supporting feet



Legs sold separately
Stirrer optionally available!

Ref. no.	Heating output	Height	Ø	Plug type			€
141450	2.500 W	63 cm	45,5 cm	with safety plug	1	6	

Ref. no.	Description	Colour	Material	Ø	Weight		€
141461	Cover with agitator	blue		44,5 cm	14,5 kg	1	
141462	Supporting feet		stainless steel		5,1 kg	1	



Milk Heater FastHeat

FastHeat and FastHeat Digital

The latest generation calf milk heater.

Calf milk heaters from the FastHeat range combine functional design with clear time and energy savings.

Energy saving

At just 1700 W, the new FastHeat calf milk heaters use much less energy than conventional products. The patented design and reduced height of the cast aluminium radiator enable even low fill levels to be heated to the desired temperature quickly, without unnecessary energy loss.

Quick and uniform heating

FastHeat calf milk heaters make use of the milk's heat convection in a pretty smart way: The heated milk rises to the surface while the cold milk drops to the bottom of the bucket where the heater heats it up again. Because the heater is typically located in the coolest part of the milk due to its reduced build height (bottom of the bucket), it can transfer its heating energy to the milk at full capacity, and thus quite efficiently. This ensures efficient and uniform heating of the milk.

From 18 °C to 42 °C in around 11 minutes (bucket holding 8 litres of water).



Milk heater for calf feeding FastHeat Digital

- digital control with steplessly-selectable temperatures (from 10 °C to max. 90 °C)
- stores the last target temperature set
- illuminated display
- visual and audible signal output, e.g. when the set target temperature is reached
- safety cut-out in the event of dry operation
- connecting cable holder so that the connecting plug always stays dry
- with practical and reliable handle
- extremely lightweight - only 2.7 kg (around 25 % lighter than standard products)
- easy to clean thanks to PTFE-coated heater element
- with thermal fuse
- 3 m connecting cable



Optimised for feeding buckets with volumes up to 10 litres



Very easy to clean thanks to its patented shape and PTFE coating!

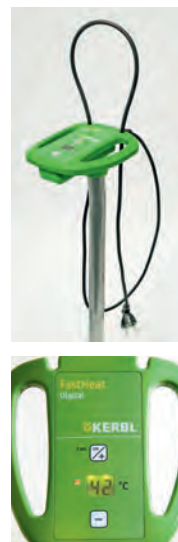

Technical data	14160
Voltage	230 V
Mains frequency	50 Hz
Diameter of the heating element	16,5 cm
Dip depth	8 - 69 cm
Temperature control range up to	10 - 90 °C
Weight	2,7 kg
Connecting Cable	3 m

Milk heater for calf feeding

Milk heater for calf feeding FastHeat

- with tried and tested temperature regulation making it easy to operate with the usual comfort
- visual signal output, e.g. when the set target temperature is reached
- with practical handle
- extremely lightweight - only 2.7 kg (around 25 % lighter than standard products)
- easy to clean thanks to PTFE-coated heater element
- with thermal fuse
- 3 m connecting cable

Technical data	14150
Voltage	230 V
Mains frequency	50 Hz
Diameter of the heating element	16,5 cm
Dip depth	8 - 69 cm
Temperature control range up to	90 °C
Weight	2,7 kg
Connecting Cable	3 m



Very easy to clean thanks to its patented shape and PTFE coating!



Ref. no.	Colour	Heating output	Height	Plug type			€
14150	white	1.700 W	81,5 cm	with safety plug	1	25	

Milk heater for calf feeding EasyHeat

- with handle section for one-handed operation
- adjustable thermostat
- easy to clean thanks to a polished heater made from cast aluminium
- very stable
- powerful heating output
- can be used for fill heights starting at approx. 13 cm
- with mounting for connection cable
- 3 m connecting cable



Technical data	
Voltage	230 V
Mains frequency	50 Hz
Diameter of the heating element	16 cm
Dip depth	13 - 75 cm
Temperature control range up to	0 - 80 °C
Weight	4,7 kg
Connecting Cable	3 m



Ref. no.	Colour	Heating output	Height	Plug type			€
14170	green	2.300 W	86 cm	with safety plug	1	20	
14170-CH	green	2.300 W	86 cm	with Swiss plug	1	24	
14172	green	3.000 W	86 cm	with safety plug	1	20	



Milk heater for calf feeding

Milk heater for calf feeding with PTFE coating and bar handle

- with practical handle for one or two-handed operation
- adjustable thermostat
- very stable
- powerful heating output
- can be used for fill heights starting at approx. 15 cm
- with thermal fuse
- 3 m connecting cable

Benefits of the PTFE (polytetrafluoroethylene) coating:

- very easy to clean thanks to the dirt-repellent nature of the PTFE coating
- absolutely acid resistant
- coating has a high temperature resistance, so the heating ring does not burn

from 18 °C to 42 °C in around 16 minutes (bucket holding 8 litres of water).

Technical data	1420
Voltage	230 V
Mains frequency	50 Hz
Diameter of the heating element	16 cm
Dip depth	15 - 69 cm
Temperature control range up to	80 °C
Weight	4,7 kg
Connecting Cable	3 m

Ref. no.	Colour	Heating output	Height	Plug type			€
1420	white	2.300 W	81,5 cm	with safety plug	1	25	



Milk heater for calf feeding with handle

- with practical handle for one or two-handed operation
- adjustable thermostat
- very stable
- powerful heating output
- can be used for fill heights starting at approx. 15 cm
- with thermal fuse
- 3 m connecting cable

from 18 °C to 42 °C in around 16 minutes (bucket holding 8 litres of water).

Technical data	1418
Voltage	230 V
Mains frequency	50 Hz
Diameter of the heating element	16 cm
Dip depth	15 - 69 cm
Temperature control range up to	80 °C
Weight	4,7 kg
Connecting Cable	3 m



Ref. no.	Colour	Heating output	Height	Plug type			€
1418	white	2.300 W	81,5 cm	with safety plug	1	25	





Calf box

The calf box ensures that the calf enjoys plenty of fresh air, but is not exposed to any draughts. It is also protected from harmful pathogenic bacteria. The animal does not lie directly on the floor in the calf box, but rather on the raised grille. This keeps the calf warmer and dryer. The calf box is available in two sizes.

- stable, hot dip-galvanised metal frame
- GRP base grille (two-part) offering excellent grip and anti-slip properties
- easy-to-clean side walls made from PVC panels with smooth surface
- the open gap in the upper area of the side walls allows the calf to have visual contact with its neighbours
- revolving door which opens in both directions
- includes a watering bucket mounting bracket and two foldable bucket brackets
- Bucket not included
- Comes disassembled



Top Seller

Single calf houses



Feeding places can be individually blocked



roof optionally available



The folding handle on the front make moving it exceptionally easy



Can be transported with pallet forks



transport device optionally available





Suitable in accordance with animal welfare regulations:

Our calf houses and boxes comply with animal welfare regulations and have the optimum design for the requirements of calf rearing. Find out more online at www.kerbl.de





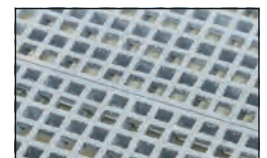

Local animal protection regulations must be observed!
Please note separate freight costs.

Technical data	14610	14611
External hut dimensions	173 x 93 x 131 cm	201 x 107 x 131 cm
House inner dimensions	130 x 85 x 106 cm	160 x 100 x 106 cm
House weight	121 kg	160 kg

Outer dimensions incl. bucket holder

Ref. no.	Description			€	
14610	Calf box small	1	5		
14611	Calf box large	1	5		



Ref. no.	Description	Length	Width	Height	Weight			€	
14612	Roof for calf box small	153 cm	98 cm	3,5 cm	22 kg	1	24		
14613	Roof for calf box large	180 cm	120 cm	3,5 cm	25 kg	1	25		
14609	Transport Device for calf box					1	50		
14610-1	GRP Base Grille for calf box small (two part)	130 cm	85 cm	2,5 cm	15,6 kg	1			
14611-1	GRP Base Grille for calf box large (two part)	160 cm	100 cm	2,5 cm	22 kg	1			
14611-2	PVC panel Calf box for side wall	165 cm	3 cm	25 cm		1			
14611-3	PVC panel Calf box for rear wall	97 cm	3 cm	25 cm		1			



CalfHouse PE UV+

The especially robust one!

High stability and durability are ensured because it is made from high-quality, impact-resistant HDPE plastic with integrated UV stabilisers. The hut entrance threshold, reinforced with steel tubes, ensures a high level of stability. Optimal climate control of the Calf House is achieved via the adjustable ventilation flap that can be fixed at all levels. This also makes it easy to fill the Hay Rack. The especially smooth interior surfaces make cleaning child's play and thus improves hygiene.

- increasing roof slope with ventilation openings ensure optimum air circulation so that humid air can heat escape at the top
- pure white surfaces prevent overheating of the interior space
- additional UV stabilisers prevent the calf house heating excessively and reduce the natural degeneration of the material
- Bucket, feed box and hay rack not included

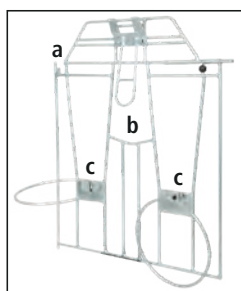
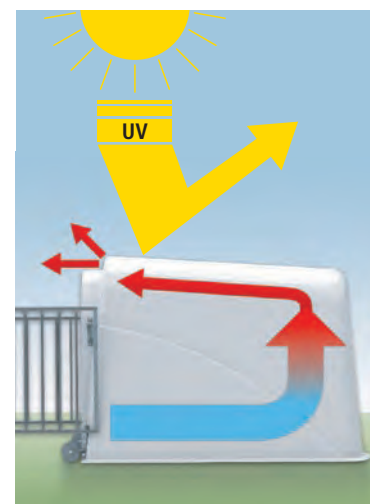

Multifunctional revolving doors:

- Flex rail (a) with drinking bucket and bucket safety catch (b), 2 feed openings (c), with hinged bucket holders for feed buckets
- The high position of the feed bucket promotes the natural stretching of the neck, so that the milk can pass directly into the abomasum.
- The bucket's inclined position ensures it is fully emptied
- Flex rail for variable mounting of the bucket holder and the optional dry feed bottle holder



14566



14570

Lightweight fencing:

The reduced weight of the lightweight fencing (approx. 30 kg) makes it easier to lift and to reposition the house integrated in the fence, while also offering a high degree of stability.

Heavyweight fencing:

The heavyweight version (approx. 45 kg) is extremely robust and its increased weight ensures even greater stability.

Single calf houses

Practical and convenient



Barrier near the base of the fence allows unimpeded access



Tip the hut into the fence for easy cleaning or repositioning



To clean the forecourt, fold the fence over the hut



Handle for easy lifting



Threshold at the hut entrance stops bedding getting out



The revolving door can optionally also be placed in the house entrance to lock the calf in



Side guards stop calves from slipping through and lend stability









Large solid rubber tyres with needle bearing enable easy moving





Suitable in accordance with animal welfare regulations:

Our calf houses and boxes comply with animal welfare regulations and have the optimum design for the requirements of calf rearing. Find out more online at www.kerbl.de

Local animal protection regulations must be observed!
Please note separate freight costs.

Technical data	14565	14566	14570
House material	polyethylene	polyethylene	polyethylene
External hut dimensions	205 x 115 x 135 cm	205 x 115 x 135 cm	205 x 115 x 135 cm
House weight	37,5 kg	37,5 kg	37,5 kg
Fencing dimensions		150 x 110 x 96 cm	150 x 110 x 96 cm
Fencing weight		approx. 30 kg	approx. 45 kg

Ref. no.	Description			€	
14565	CalfHouse PE UV+ without fencing	1	17		
14566	CalfHouse PE UV+ with light fencing	1	4		
14570	CalfHouse PE UV+ with heavy fencing	1	4		

Ref. no.	Description	Material	Length	Width	Height	Weight			€	
145620	Fence Easy	metal galvanised	150 cm	110 cm	96 cm	30 kg	1	24		
14572	Fence heavy	metal galvanised	150 cm	110 cm	96 cm	45 kg	1	22		
14568	Door and Tyre Set for CalfHouse PE UV+					13 kg	1	34		
14567	threshold Retrofit Kit	metal	98 cm	2,5 cm	17 cm	2,2 kg	1	200		
3230	Hay Rack small model	metal galvanised	56 cm	29,5 cm	23 cm		1	78		



CalfHouse Premium Plus

More space! More stability!

This Calf House, increased in both length and height, offers the calf improved protection from the weather and gives farmers more space when handling the calf. The CalfHouse Premium Plus is built using special fibreglass material with a very high surface mass. This gives it excellent resistance against tears and impacts. The wall construction is also additionally reinforced in all edge areas and in the corners of the calf house. The easy-to-clean plastic barrier improves hygiene. This Calf House also has an optimal ventilation system that regulates the climate in the house without any draughts. Bucket not included

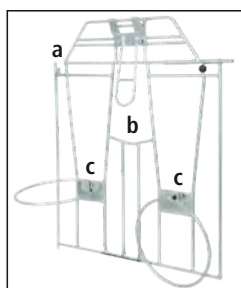

Multifunctional revolving doors:

- Flex rail (a) with drinking bucket and bucket safety catch (b), 2 feed openings (c), with hinged bucket holders for feed buckets
- The high position of the feed bucket promotes the natural stretching of the neck, so that the milk can pass directly into the abomasum.
- The bucket's inclined position ensures it is fully emptied
- Flex rail for variable mounting of the bucket holder and the optional dry feed bottle holder

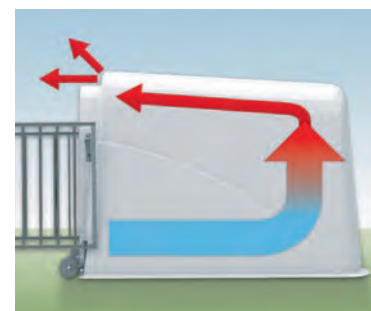

14580



14585

Lightweight fencing:

The reduced weight of the lightweight fencing (approx. 30 kg) makes it easier to lift and to reposition the house integrated in the fence, while also offering a high degree of stability.

Heavyweight fencing:

The heavyweight version (approx. 45 kg) is extremely robust and its increased weight ensures even greater stability.



Single calf houses

Practical and convenient



Barrier near the base of the fence allows unimpeded access



Tip the hut into the fence for easy cleaning or repositioning



To clean the forecourt, fold the fence over the hut



Handle for easy lifting



Threshold at the hut entrance stops bedding getting out



The revolving door can optionally also be placed in the house entrance to lock the calf in



Side guards stop calves from slipping through and lend stability



Large solid rubber tyres with needle bearing enable easy moving

Suitable in accordance with animal welfare regulations:

Our calf houses and boxes comply with animal welfare regulations and have the optimum design for the requirements of calf rearing. Find out more online at www.kerbl.de

Local animal protection regulations must be observed!
Please note separate freight costs.

Technical data	14581	14580	14585
House material	GFK	GFK	GFK
External hut dimensions	210 x 115 x 145,5 cm	210 x 115 x 145,5 cm	210 x 115 x 145,5 cm
House weight	37 kg	37 kg	37 kg
Fencing dimensions		150 x 110 x 96 cm	150 x 110 x 96 cm
Fencing weight		approx. 30 kg	approx. 45 kg

Ref. no.	Description			€	
14581	CalfHouse Premium Plus without fencing	1	10		
14580	CalfHouse Premium Plus with light fencing	1	4		
14585	CalfHouse Premium Plus with heavy fencing	1	4		

Ref. no.	Description	Material	Length	Width	Height	Weight			€	
144720	Fence Easy	metal galvanised	150 cm	110 cm	96 cm	30 kg	1	24		
144322	Fence heavy	metal galvanised	150 cm	110 cm	96 cm	45 kg	1	22		
14304	threshold	Plastic	100 cm	2,3 cm	14,5 cm	4 kg	1	168		



CalfHouse Master Plus

The CalfHouse Master Plus, which has proven itself over 10,000 times, profits from our skill and many years of experience in the design of high quality Calf Houses, and unifies all the proven features of the CalfHouse series regarding stability, comfort and animal well-being – at an excellent price/performance ratio. With its generous dimensions, the CalfHouse Master Plus, made from glass fibre reinforced plastic offers the calf protection from the weather and free space for handling by the farmer. This Calf House also has an optimal ventilation system that regulates the climate in the house without any draughts.

- Bucket and feed box not included

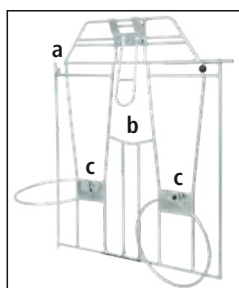
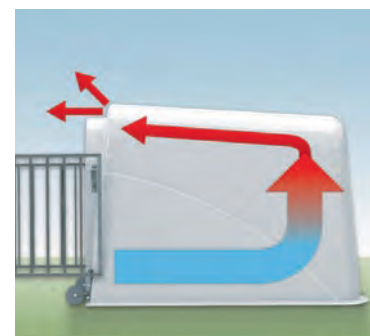

Multifunctional revolving doors:

- Flex rail (a) with drinking bucket and bucket safety catch (b), 2 feed openings (c), with hinged bucket holders for feed buckets
- The high position of the feed bucket promotes the natural stretching of the neck, so that the milk can pass directly into the abomasum.
- The bucket's inclined position ensures it is fully emptied
- Flex rail for variable mounting of the bucket holder and the optional dry feed bottle holder



Lightweight fencing:

The reduced weight of the lightweight fencing (approx. 30 kg) makes it easier to lift and to reposition the house integrated in the fence, while also offering a high degree of stability.



Heavyweight fencing:

The heavyweight version (approx. 45 kg) is extremely robust and its increased weight ensures even greater stability.

Single calf houses

Practical and convenient



Barrier near the base of the fence allows unimpeded access



Tip the hut into the fence for easy cleaning or repositioning



To clean the forecourt, fold the fence over the hut



Handle for easy lifting



Threshold at the hut entrance stops bedding getting out



The revolving door can optionally also be placed in the house entrance to lock the calf in



Side guards stop calves from slipping through and lend stability









Large solid rubber tyres with needle bearing enable easy moving





Suitable in accordance with animal welfare regulations:

Our calf houses and boxes comply with animal welfare regulations and have the optimum design for the requirements of calf rearing. Find out more online at www.kerbl.de

Local animal protection regulations must be observed!
Please note separate freight costs.

Technical data	14301	14470	14485
House material	GFK	GFK	GFK
External hut dimensions	200 x 115 x 135 cm	200 x 115 x 135 cm	200 x 115 x 135 cm
House weight	27 kg	27 kg	27 kg
Fencing dimensions		150 x 110 x 96 cm	150 x 110 x 96 cm
Fencing weight		approx. 30 kg	approx. 45 kg

Ref. no.	Description			€	
14301	CalfHouse Master Plus without fencing	1	12		
14470	CalfHouse Master Plus with light fencing	1	4		
14485	CalfHouse Master Plus with heavy fencing	1	4		

Ref. no.	Description	Material	Length	Width	Height	Weight			€	
144720	Fence Easy	metal galvanised	150 cm	110 cm	96 cm	30 kg	1	24		
144322	Fence heavy	metal galvanised	150 cm	110 cm	96 cm	45 kg	1	22		
14304	threshold	Plastic	100 cm	2,3 cm	14,5 cm	4 kg	1		168	
14302	threshold	Larch	100 cm	2,3 cm	14,5 cm	1,8 g	1		168	



CalfHouse Premium XL

New product

NEW

The multi-animal Calf House made from glass fibre reinforced plastic offers space for up to 5 calves (local animal protection regulations must be observed). A sliding window is placed at the back to make animal control and filling the optional hay rack, among other things, easier. The additional reinforcing frame around the Calf House ensures the highest stability. The Calf House with fence provides optimum oversight and makes animal control easier.

- Feeding places can be individually blocked
- Side grilles can easily be swung back against the cabin walls
- easy access via large entrance door, even a calf transporter fits through the door
- pre-drilled holes on runners for straw catching and floor securing
- House and fencing easy to transport with a tractor
- Feeding bucket and long feeder troughs not included

14520: Included: Hut incl. reinforcing frames and fencing, eyebolts, wooden sleeper, drinking bucket holder and two trough holders for long feed troughs (item no. 3268).

Versatile and robust



Catch grille:

- With 5 or 7 feeding places
- With catch system: Individual and complete locking possible
- Lockable, fold-up drinking bucket holder, also length and height-adjustable
- Adjustable feeding place width
- Incl. trough holder
- Catch grille width information: with drinking bucket holder, max. length



Side and catch grilles can be arranged as required



The reinforcing frame gives the house additional stability



Catch grille can be hung back on the house

Large Calf Houses



House and fencing easy to transport with a tractor



Optional feeding space separation



The optional canopy provides protection against weather and sun

CalfHouse Premium XL with catch grille (item no. 14539)

- Suitable for 2 – 3 calves (local animal protection regulations must be observed)
- Catch grille can be opened and swung up on both sides
- To prevent calves from stepping in the gap between the house and the catch grille while drinking, the optional kit plate set item no. 14529 can be retrofitted.

New product



14539

Twin set, CalfHouse Premium XL with fence (item no. 14530)

- Also available as a twin set for up to 10 calves
- Tip: With an additional fence component, the twin set can quickly and easily be divided into two bays.

New product



14530

Suitable in accordance with animal welfare regulations:

Our calf houses and boxes comply with animal welfare regulations and have the optimum design for the requirements of calf rearing. Find out more online at www.kerbl.de

Local animal protection regulations must be observed!
Please note separate freight costs.

Technical data	14520	14518	14539	14530
House material	GFK	GFK	GFK	GFK
External hut dimensions	238 x 223 x 189 cm	238 x 223 x 189 cm	238 x 223 x 189 cm	238 x 223 x 189 cm
House weight		104 kg		
Fencing dimensions	209 x 221 x 120 cm			209 x 447 x 120 cm

Ref. no.	Description		€	
14520	CalfHouse Premium XL with fencing	1		
14518	CalfHouse Premium XL single	1	4	
14539	CalfHouse Premium XL with catch grille	1		
14530	CalfHouse Premium XL with fencing; 2-piece set	1		

Ref. no.	Description	Material	Length	Width	Height	suitable for	MOQ	Pieces / unit	€	
14466	Canopy	Polyester PVC-coated	300 cm	270 cm				1		
14524	Reinforcing Frame	metal galvanised						1		
14526	Trough Holder for long feed trough	metal galvanised	82 cm	13,5 cm	18 cm	3268		1	100	
14527	Holder for 5 concentrated feed buckets	metal galvanised	184 cm	42 cm	20 cm			1	36	
14529	Tread Protection Set							1		
14528	Feeding place separator	metal galvanised	37,5 cm	14 cm	55,2 cm		1 pack	2 / pack	1	50
14458	threshold	Larch	203 cm	3,5 cm	19 cm			1	52	
14454	Hay Rack	metal galvanised	113 cm	41 cm	38 cm			1	50	
14522	Fence for CalfHouse Premium XL	metal galvanised						1		



TV

CalfHouse Premium XXL

New product

NEW

The large-area Calf House made from glass fibre reinforced plastic offers space for up to 7 calves (local animal protection regulations must be observed). The additional reinforcing frame around the Calf House ensures the highest stability for even large animals. The swivelling ventilation slots control the air circulation in the back area of the Calf House. A sling bar is attached at the house roof ridge to enable easy lifting and transporting. The Calf House with fence provides optimum oversight and makes animal control easier.

- Feeding places can be individually blocked
- Side grilles can easily be swung back against the cabin walls
- easy access via large entrance door, even a calf transporter fits through the door
- pre-drilled holes on runners for straw catching and floor securing
- House and fencing easy to transport with a tractor
- Feeding bucket and long feeder troughs not included

14540: Included: Hut incl. reinforcing frames and fencing, sling bars, wooden sleeper, drinking bucket holder and four trough holders for long feed troughs (item no. 3268).

Versatile and robust



Catch grille:

- With 5 or 7 feeding places
- With catch system: Individual and complete locking possible
- Lockable, fold-up drinking bucket holder, also length and height-adjustable
- Adjustable feeding place width
- Incl. trough holder
- Catch grille width information: with drinking bucket holder, max. length



Side and catch grilles can be arranged as required



The reinforcing frame gives the house additional stability



Catch grille can be hung back on the house

Large Calf Houses



House and fencing easy to transport with a tractor



Optional feeding space separation



Suitable in accordance with animal welfare regulations:

Our calf houses and boxes comply with animal welfare regulations and have the optimum design for the requirements of calf rearing. Find out more online at www.kerbl.de

Technical data	14540	14519
House material	GFK	GFK
External hut dimensions	340 x 296 x 204 cm	340 x 296 x 204 cm
Fencing dimensions	280 x 299 x 120 cm	

Local animal protection regulations must be observed!
Please note separate freight costs.
A front-loader with forklift will be required for unloading!

Ref. no.	Description		€
14540	CalfHouse Premium XXL with fencing	1	
14519	CalfHouse Premium XXL single	1	

Ref. no.	Description	Material	Length	Width	Height	suitable for	MOQ	Pieces / unit	€
14546	Fence for CalfHouse Premium XXL	metal galvanised						1	
14526	Trough Holder for long feed trough	metal galvanised	82 cm	13,5 cm	18 cm	3268		1	100
14549	Tread Protection Set							1	
14528	Feeding place separator	metal galvanised	37,5 cm	14 cm	55,2 cm		1 pack	2 / pack	1 50

Modular fence stabling

For keeping calves in a barn or roofed area, the fencing can simply be attached to the wall using a wall bracket. Or it can be anchored to the floor. The fencing can also be put together to suit individual requirements. Choose between a catch grille, a fence part with door and feeding places and a fence part with grille. All fencing types are available in two lengths.

- pre-drilled holes on runners for straw catching and floor securing
- Bucket and long feeder trays not included.

Catch grille:

- Individual and complete locking possible
- Lockable, fold-up drinking bucket holder, also length and height-adjustable
- Adjustable feeding place width
- incl. trough holder
- Catch grille width information: with drinking bucket holder, max. length

14498, 14496, 14497: Available from March 2020

New product

NEW



Ref. no.	Description	Material	Length	Width	Height		€
14495	Wall bracket	metal galvanised				1 400	
14493	Catch grille, 5 places	metal galvanised	213 cm	52 cm	120 cm	- 1	
14498	Catch grille, 7 places	metal galvanised	285 cm	52 cm	120 cm	- 1	
14491	Fence part with door and feeding places, short	metal galvanised	215 cm	3 cm	120 cm	- 1	
14496	Fence part with door and feeding places, long	metal galvanised	285 cm	3 cm	120 cm	- 1	
14492	Fence part grille, short	metal galvanised	215 cm	3 cm	120 cm	- 1	
14497	Fence part grille, long	metal galvanised	285 cm	3 cm	120 cm	- 1	

Ref. no.	Description	Material	Length	Width	Height	suitable for	MOQ	Pieces / unit	€
14526	Trough Holder for long feed trough	metal galvanised	82 cm	13,5 cm	18 cm	3268		1	
14527	Holder for 5 concentrated feed buckets	metal galvanised	184 cm	42 cm	20 cm			1	
14528	Feeding place separator	metal galvanised	37,5 cm	14 cm	55,2 cm		1 pack	2 / pack	1

Combo Feed Box small

With galvanised rack inlay for the combined feeding of concentrated feed and hay. Ideal for calves switching from wet to dry feed.

- suitable for all individual calf houses • can be hung on the inside of the fence • can easily be filled from the outside • cover protects contents from the rain • sturdy plastic container



Ref. no.	Colour	Width	Depth	Height	Capacity			€
144352	green	330 mm	512 mm	270 mm	11,5 L	1	40	

Concentrated Feed Box small

With panel insert for the feeding of concentrated feed.

- suitable for all individual calf houses • can be hung on the inside of the fence • can easily be filled from the outside • cover protects contents from the rain • sturdy plastic container



Ref. no.	Colour	Width	Depth	Height	Capacity			€
144353	green	330 mm	512 mm	270 mm	13 L	1	40	

Combo Feed Box

For combined feeding of roughage and concentrates



- easy filling possible • Protects feed from rain
- Drainage in feed bowl for easy cleaning • is mounted externally to the feed opening • suitable for individual calf houses and calf boxes • includes hanging bracket • Rack capacity: 20 L • Feed bowl capacity: 5.5 L



New product

NEW



Ref. no.	Length	Width	Height			€
144355	300 mm	380 mm	730 mm	1	18	



Feed Trough Long

for hanging

- especially stable with glass fibre reinforced plastic • extra-strong loops • fits plug trays and nearly every device of up to 50 mm size
- Dimensions: Depth 35 cm (28 cm without mounting bracket) • for hanging



Ref. no.	Colour	Width	Depth	Height	Capacity			€
3268	green	100 cm	35 cm	24 cm	42 L	1	120	

Ref. no.	Description	Material	Length	Width	Height	suitable for		€
14526	Trough Holder for long feed trough	metal galvanised	82 cm	13,5 cm	18 cm	3268	1	NEW

Feeding Bowl

- universal bowl for food • impact- and temperature-resistant plastic • bowl and lid can be printed on request • food safe



Available in customer-specific composition. Note the instructions at the end of the catalogue.

Made in the EU



Ref. no.	Colour	Ø	Capacity		€
324811	grey	31,5 cm	6 L	1/5	
324812	green	31,5 cm	6 L	1/5	
324815	aquamarine	31,5 cm	6 L	1/5	
324816	rosé	31,5 cm	6 L	1/5	
324813	olive green	31,5 cm	6 L	1/5	NEW



Ref. no.	Description	Colour		€
324820	Cover for feed bowl 6 litres	white	1/5/50	

Feeding Bowl stainless steel

- universal bowl for food • especially sturdy and hygienic • ideal for use in stables • Material: stainless steel stainless



New product



Ref. no.	Ø	Capacity		€
324828	30 cm	5,5 L	1/50	



Top Seller



Made in the EU



All-Purpose Bucket

- very sturdy design • Material: Plastic

Available in customer-specific composition. Note the instructions at the end of the catalogue.

Ref. no.	Description	Colour	Ø	Capacity			€
29881		olive green	33 cm	12 L	1	350	
29880	food safe	blue transparent	33 cm	12 L	1	350	
298801	food safe	transparent pink	33 cm	12 L	1	350	

Ref. no.	Description	Colour		€
29935	Cover for stable and construction bucket	black	1/30	

Bucket Mount

- robust • for hanging buckets and food bowls
- clip-on

321216:

- Bucket ring can be folded away when not in use
- for wall mounting

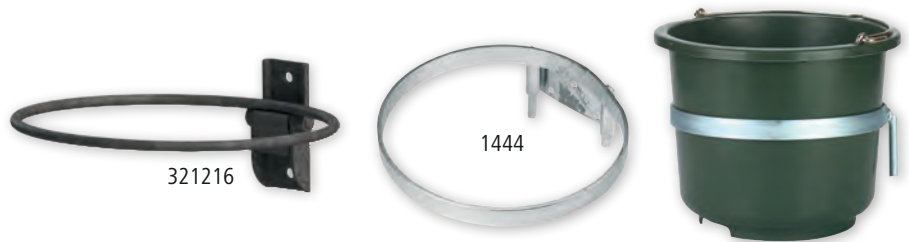

Ref. no.	Description	Material	Ø			€
1444	Standard	metal galvanised	29,5 cm	1	310	NEW
321216	foldable, for wall mounting	metal galvanised	28 cm	1/10	480	
1445	Dutch model	metal galvanised	28 cm	1	340	

Holder for 5 concentrated feed buckets

- suitable for e.g. stable and construction buckets (29881) and feed bowls (324811-324816) • for CalfHouse Premium XL (14520) • also suitable for wall mounting

New product

NEW

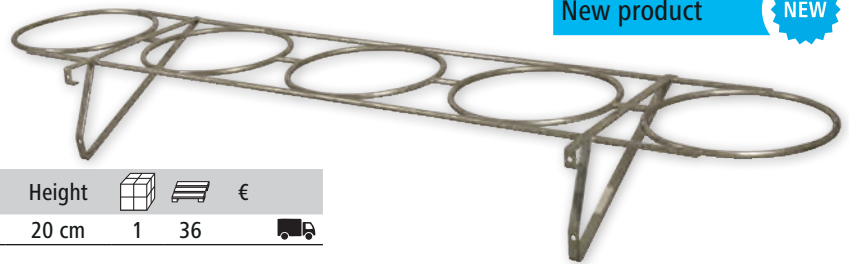

Ref. no.	Material	Length	Width	Height			€
14527	metal galvanised	184 cm	42 cm	20 cm	1	36	

Hay Rack

- suitable for CalfHouse Premium 4/5, FLIXBOX group igloo, CalfHouse Premium XL and CalfHouse Premium XXL
- Material: metal galvanised • screw-on fastening



Ref. no.	Length	Width	Height	Rod distance	Bar thickness			€
14454	113 cm	41 cm	38 cm	75 mm	10 mm	1	50	

Feed Trough Long with float valve

Simple water supply for your animals without any installation work. Connect the hose - and that's it!

- float valve can be used on both sides of the trough • pipe piece and cover made from stainless steel • inc. click coupling for garden hose
- for hanging • Material: Plastic



Technical data	223111
Dimensions (W x D x H)	100 x 35 x 24 cm

Ref. no.	Colour	Water connection	Capacity		€
223111	green	1/2"	42 L	1	

Ref. no.	Description		€
223113	Floating valve	1/10	NEW

Mounting Set for drinking trough

- for mounting on calf house fencing • suitable for all water bowls

Ref. no.	Description		€
221972	Mounting Set for drinking trough	1	

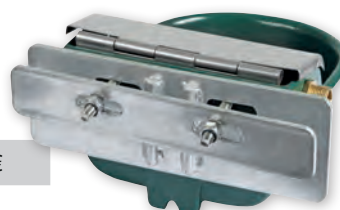

Occupational items for calves

The purpose of occupational items is to calm their unmet desire to suckle and provide an outlet for their energy. They also help to prevent misbehaviour (e.g. mutual suckling). Calves' acceptance and interest in these items is very high and also long-lasting. The calves like playing and busying themselves with the various toys.

'Toys for young animals' immediately create a positive and friendly impression in the calf shed.

Scratch Mat

- made from natural rubber material • mobile and soft nubs provide optimum coat care without risk of skin irritation • rectangular shape with many mounting holes for stable mounting • multi-functional applications such as flat on the wall or around pillars, posts or corners



Ref. no.	Colour	Length	Width		€
32678	black	40 cm	30 cm	1/12	
32689	black	60 cm	40 cm	1/6	

Scratch Brush

- ensures ideal fur cleaning and care • head and throat in particular can be cleaned • suitable for cattle and calves, horses, goats etc.
- various mounting options (walls, corners, stables, posts) • Bristle material: Polyamide • Bristle length: 5 cm

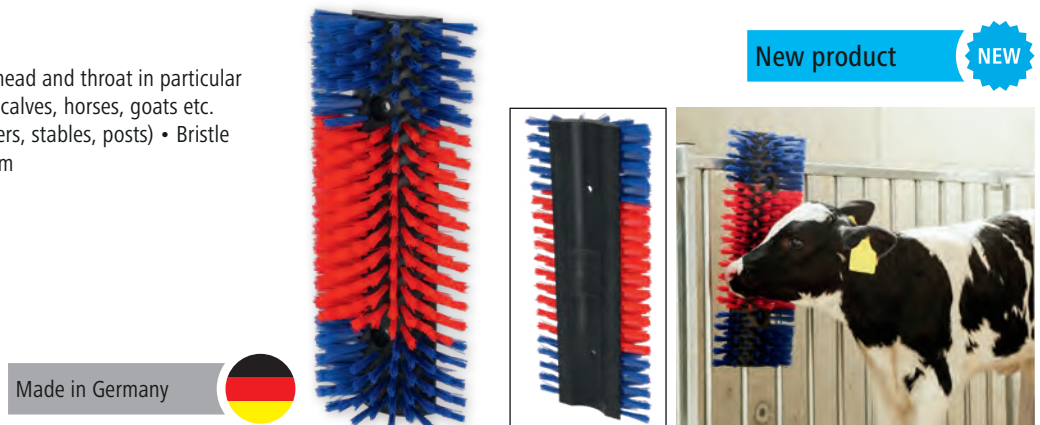

Made in Germany



Ref. no.	Colour	Width	Depth	Height		€
293100	red / blue	22 cm	9 cm	50 cm	1	

TV

Feed Ball Toy HeuBoy

- the ball is especially suitable for use in stables, pastures or paddocks
- 19 feed openings per 70 mm • durable UV-resistant plastic • for up to 3 kg of hay • Filled via 116 mm filling opening with screw cap
- can also be hung on a cable or chain

- Calves enjoy playing with the swinging ball or eat hay from it
- Suitable for group housing

Ref. no.	Colour	Ø	Ø thread		€
3210385	blue	40 cm	60 mm	1	
3210386	red	40 cm	60 mm	1	

Ref. no.	Description		€
3210385-1	Cover for HeuBoy	1/80	



Made in the EU

HayBag

The HayBag brings together many benefits in one product.

- up to 15 % less feed wastage • smooth, soft material surface prevents injuries
- easy to fill and clean • ideal for species-appropriate feeding of hay • universally usable and easy to mount in stables or pasture • Material: Plastic

326102: 12 side holes with 20 cm spacing
326103: 15 side holes with 20 cm spacing

- Calves have to work for their food and engage in a playful way
- Suitable for group housing



New product

NEW



Ref. no.	Description	Colour	Capacity	Capacity		€
326102	Small	black	8 kg	85 L	1/10	
326103	Big	black	16 kg	195 L	1/10	

Ref. no.	Description	Material	suitable for		€
323506	Wall Mount	metal galvanised	323500, 326102, 326103, 323509	1/10	
326104	Floor bracket	metal galvanised	323520, 326102, 326103	1	



Teat Activity Set

- Calves can fulfil their unmet need to suckle • for easy wall mounting
- suitable for individual and group housing

Ref. no.	Description		€
14129	Teat Activity Set	1	

Ref. no.	Description	Colour		€
14128	Calf Teat without holes	blue	1/50	



New product

NEW

Play Rope

- made from organic natural materials (100 % cotton)
- on a coil • woven
- Calves are attracted to this and enjoy gnawing at it
- Suitable for individual and group housing



Ref. no.	Length	Thickness		€
22681	250 m	8 mm	1/2	



New product

NEW

Teething Ring Nature

- made from food-grade, naturally renewable raw materials • made from polylactic acid derived from sugar cane, reinforced with wood fibres • organic, changeable, healthy and harmless material to keep animals occupied • GM-free • biodegradable • long service life • biocompatible • carefully selected, HACCP-compliant hardwood from sustainable forest management

Ref. no.	Description	Colour	Ø		€
22638	without hanging chain	nature	18 cm	1/50	
22639	with hanging chain 75 cm	nature	18 cm	1/50	

Ref. no.	Description	Material	Length	Link thickness		€
22607	Hanging Chain with ring	metal galvanised	75 cm	4 mm	1/25/100	
22608	Hanging Chain with ring	metal galvanised	75 cm	6 mm	1/25	



New product

NEW

- Calf blankets support the immune system during the first few days and prevent diarrhoea and other illnesses
- The risk of illness increases at temperatures below 10 °C
- Protection against sudden changes in the weather
- Avoids cold stress in new-born calves
- The calves generally wear the calf blankets for 3 to 4 weeks, and longer if necessary
- Calf blankets are not suitable for group housing

Calf blanket EasyWear

- super lightweight and functional calf blanket for all year round
- special padding regulates the temperature and ensures excellent thermal insulation
- wind- and water-resistant due to welded stitching
- no protruding belt, thus low risk of injury for the calf
- stable plastic fasteners
- machine washable at 30 °C



Ref. no.	Colour	Total length		€
14194	dark blue	70 cm	1/25	
14195	dark blue	80 cm	1/25	



Calf blanket ThermoPlus

- outer materials made from tear-resistant 600 denier ribstop polyester • with anatomical chest and belly fastener • stable closures with additional hook and loop security • water-resistant up to 3,000 mm water column • 200 g polyfleece filling for optimum protection even in extreme outdoor temperatures • breathable properties prevent excessive sweating • machine washable at 30 °C



Ref. no.	Colour	Total length		€
14148	dark blue	70 cm	1/15	
14149	dark blue	80 cm	1/15	

Calf blanket Ripstopp

- outer materials made from tear-resistant 600 denier ribstop polyester • with Nylon strap and plastic clip fasteners • water-resistant material with up to a 3000 mm water column • breathable properties prevent excessive sweating • machine washable at 30 °C



Ref. no.	Colour	Total length		€
14155	grey	70 cm	1/25	
14156	grey	80 cm	1/25	

Mark of quality for feed from the Bavarian Farmers' Association

Farms taking part in the 'Offene Stalltür' (Open Barn Door) programme commit themselves to using only feed bearing this stamp. This guarantees general animal feed safety at these farms. Agrochemica quality products are also GMP+ and QS certified.

Quality for feed



Bolus Phosphogol

Phosphorus bolus for dairy cows

Cows with optimum phosphorus supply have a better start to lactation, are healthier and produce more milk. Phosphorus deficiency occurs ever more frequently in calving cows. The Phosphogol bolus enables the targeted supply of phosphorus around calving time.

- very high content of rapidly available phosphorus (37 g) per bolus! • additional supply of calcium (15 g) • easy application and economical – one bolus per dose is enough • the administration in combination with the Calzogol bolus ensures an adequate supply of calcium and phosphorus at the same time

Feeding recommendation:

Administer one bolus with the applicator as per the instructions when calving. If required, administer a second bolus approx. 12 hours after birth.



New product

NEW

Quality for feed



Ref. no.	Single weight	MOQ	Pieces / unit		€
15987	185 g	1 pack	4 / pack	1/8	

Feed supplement for dairy cows

Bolus Calzogol

Calcium bolus (milk fever)

- Cows with optimum calcium supply have a better start to lactation, are healthier and produce more milk. • very high levels of fast and slow availability calcium (45 g) and vitamin D3 (40,000 I.E.) per bolus! • calcium sources with varying release rates supply the cow evenly with calcium • very well tolerated by membranes – no irritation of the mouth, esophagus and rumen • no caustic calcium chloride • easy application and economical – one bolus per dose is enough

Feeding recommendation:

Administer one bolus with the applicator as per the instructions when calving. If required, administer a second bolus approx. 12 hours after birth.



Quality for feed



Ref. no.	Single weight	MOQ	Pieces / unit		€
15980	175 g	1 pack	4 / pack	1/8	

Dietary mineral feed for milk cows to lower the risk of milk fever. High calcium content in the form of readily available calcium salts.

Bolus Ket-o-Vital®

Energy Bolus (Ketosis)

- Healthy cows become pregnant quicker and provide more milk. • Bolus that works on various physiological levels – liver - rumen - immune system • the glucoplastic substances support the energy metabolism. The risk of ketosis / acetoaemia decreases. Very high milk yield, birth problems, stress, heat and obesity at the time of birth are classical risk factors for ketosis • safe dosage and application. The animals have more appetite, are fitter and recover faster

Feeding recommendation:

Administer two boluses shortly after calving using a bolus applicator as per the instructions. If required, administer another bolus 12 hours after calving.



Quality for feed



Ref. no.	Single weight	MOQ	Pieces / unit		€
15982	135 g	1 pack	4 / pack	1/8	

Dietary supplementary feed for milk cows to lower the risk of milk ketosis. Glucose-supplying raw materials.

Bolus Fertilgol

Beta Carotene Bolus (fertility)

- A quick pregnancy shortens the calving interval and improves economic success.
- for male and female breeding animals just before and during the covering or insemination period
- supports a successful embryo transfer (recipient and donor animals)
- the high beta carotene content aids the corpus luteum formation, colostrum quality, the oestrus cycle and sperm quality
- a well-developed corpus luteum has a positive influence on the embryonic survival rate
- easy and safe application through the even release of beta carotene, vitamins and trace elements over a period of min. 20 days
- the release rate has been scientifically confirmed

Feeding recommendation:

Female cows: Administer the first bolus 30 days before insemination. Administer the second bolus shortly before or after insemination

Stud bulls: Administer one bolus every 20 – 30 days during breeding season. The bolus dissolves in 20 days in the rumen

Ref. no.	Single weight	MOQ	Pieces / unit		€
15983	95 g	1 pack	8 / pack	1/8	



Quality for feed



Dietary mineral feed (for cattle with fully developed rumen) to support preparation for oestrus and reproduction. High content of vitamin A

Bolus Vitagol

Mineral Vitamin Bolus (Vitality)

Well-nourished animals have the best conditions for good growth, vitality and fertility

- for male and female cattle
- the long-term bolus releases vitamins and trace elements safely and evenly over a period of at least 90 days. The release rate has been scientifically confirmed
- a constant supply of essential vitamins and trace elements cannot be safely guaranteed with conventional feed, especially in pastures / hill farms / mountain farms. The solution is the Vitagol long-term bolus.
- individual animals in a herd can be targeted for a boost of vitamins and trace elements

Feeding recommendation:

Young cattle < 300 kg live weight: one bolus every 3 months, administer using a bolus applicator as per the instructions.

Cattle > 300 kg: two boluses every 3 months, administer using a bolus applicator as per the instructions.

Ref. no.	Single weight	MOQ	Pieces / unit		€
15981	110 g	1 pack	8 / pack	1/8	



Quality for feed



Dietary mineral feed (for ruminants with fully developed rumen) for the long-term supply of trace elements and/or vitamins to grazing animals. High content of trace elements and vitamins.

Bolus Bufferlyt

Buffer and Electrolyte Bolus

For digestive problems, low appetite and reluctance to drink

- Sodium bicarbonate is a very effective buffer. The use of buffers helps to resist excess acidity. Excess acidity is often the reason why calves are weak and dull and have no desire to drink
- Lost electrolytes are effectively replaced. This stabilises water levels during e.g. transport and heat
- stress-free and safe administration. Administration can also be done without an applicator. Simply place the bolus lengthways on the base of the tongue using your hand. The calf will swallow the bolus with no problems
- applicator not included

Feeding recommendation:

Immediately administer one bolus as per the instructions at the first signs of digestive problems.. Then administer one bolus after each liquid meal for 2 – 3 days.

Ref. no.	Single weight	MOQ	Pieces / unit		€
15984	13 g	1 pack	15 / pack	1/12	

Ref. no.	Description		€
15985	Introducer for Bolus Bufferlyt	1/12	



15985

Mineral feed (for calves) for additional supply of buffers and electrolytes.

Quality for feed



Introducer

for bolus and ruminal magnet

- for single-handed operation
- rounded edges
- Introducer sleeve: internal diameter 36 mm, length 11 cm, with retaining springs
- suitable for Calzogol bolus (item no. 15980), Ket-o-Vital bolus (item no. 15982), Fertigol bolus (item no. 15983), Vitagol bolus (item no. 15981) Phosphogol bolus (item no. 15987) and cage magnets

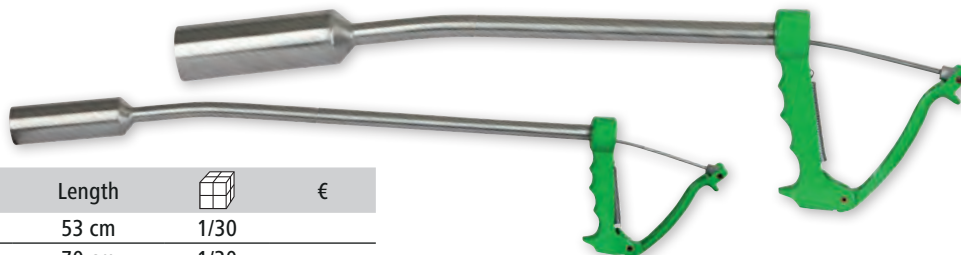

Ref. no.	Colour	Material	Length		€
2129	green	stainless steel	53 cm	1/30	
2139	green	stainless steel	70 cm	1/30	

Head Support for Cattle

- simple and safe fixing of the head
- facilitates treatments and the administration of drugs or feed
- Fastening on feed grate
- suitable for pipes with a diameter of up to max. 7.5 cm
- Reduces stress and risk of injury to animals and keepers



New product

NEW

Ref. no.		€
2164	1	

Diarrhoea Test for calves

Fast test for cattle and calves

When you want to know for sure whether or not your calf is suffering from E. coli, rotaviruses, corona viruses or cryptosporidia, then the test provides the answer. Often times, multiple infections from different pathogens occur along with the individual infections.

How to use:

- take a diarrhoea sample and mix it with the supplied reagent fluid
- next, place the mixture on the test cassette
- rapid identification of the pathogen is possible after approx. 10 minutes, so that swift initial measures can be taken, e.g. intensive disinfection

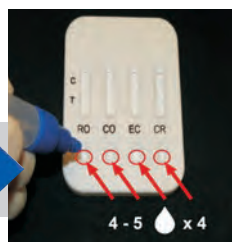

Treatment and planning reliability –
Improved success in calf rearing!



10 min

Ref. no.	Contents		€
15843	5 pieces / Pack	1/25	



Immunoglobulins are natural proteins whose clear objective is to protect vertebrates against carcinogens. Numerous university and field tests have shown that natural immunoglobulins (IgY) from eggs can act as a potent supplementary feed for protecting the as-yet immature immune system of young animals. IgY plays a key role in 'filling in the immunity gap', because it binds diarrhoea-inducing pathogens in the gut.

Globigen Colostrum

High-quality colostrum supplement for the additional supply of natural immunoglobulins in the first days of life

- Use in the case of insufficient colostrum quality or amount • Supply of natural egg immunoglobulins • supports the immune system • supports intestinal health • can reduce the frequency of diarrhoea • improves weight gain • quick and easy to use • can be stirred directly into the colostrum

Feeding recommendation:

Add to the colostrum (first milk)

Calves: 50 – 100 g per animal per day

Lambs and kids: 5 – 10 g per animal per day

Period of use: 3 – 4 days

Stir the powder into warm (approx. 39 °C) colostrum and administer during the first 6 hours of life.

To ensure the powder dissolves easily, add max. 100 g of powder per litre of milk, or max. 10 g of powder per 100 ml of milk.

Feed when no colostrum is available

Calves: Dissolve 200 g in 2 litres of normal milk, milk substitute or water

Lambs and kids: Dissolve 20 g in 0.2 litres of normal milk, milk substitute or water

Period of use: 3 – 4 days

Ref. no.	Contents		€
15993	1 kg / Can	1	
15994	2,5 kg / Bucket	1	

Feed supplement for calves, lambs and kids



Globigen Dia Stop

Stabilises the water and electrolyte balance to support physiological digestion

- supports the calf during diarrhoea • Supply of natural egg immunoglobulins • can reduce the use of antibiotics • supports intestinal health • improves weight gain • can be used preventively

Feeding recommendation:

During, after or to prevent digestive problems (diarrhoea), mix 1 slightly heaped scoop (25 g) into 1 litre of warm (39 °C) water, milk substitute or milk twice a day.

In the event of severe diarrhoea, mix 50 g of Dia Stop into 2 litres of warm water twice a day.

Ref. no.	Contents		€
15995	2 kg	1	
15996	7,5 kg	1	

Dietary supplement for calves



Globigen Calf Paste

Paste for calves to stabilise their physiological digestion

- for a successful start in life • Supply of natural egg immunoglobulins • supports the immune system • supports intestinal health • healthy intestines increases the motivation of the animals • can be used preventively • Paste for easy administration

Feeding recommendation:

Early days help from days 1 to 3 after birth: 10 ml per animal per day

In acute scenarios (e.g. increased exposure to bacteria): 10 ml per animal per day for 3 days

Ref. no.	Contents	MOQ	Pieces / unit		€
15992	30 ml / injector	1 pack	6 / pack	1/10	

Dietary supplement for calves



Udder Paper UdderoClean

- highly suitable for wet and dry cleaning • high moisture absorption for optimal wet cleaning • high-wet-strength and lint-free • stimulating effect via the crepe structure • 100 % virgin pulp • food safe • 100 % biodegradable

1579: with cardboard core



15787: no cardboard core

15800: no cardboard core

15895: no cardboard core



ideal for KerbaWasch & Udder Washing Lotion

Ref. no.	Colour	Contents	Sheet dimensions (L x W)	MOQ	Pieces / unit			€
1579	white	2 x 200 sheet / Roll	24 x 23 cm	5 pieces	5 / pack	1/5	315	
15787	white	800 sheet / Roll	23 x 22 cm	1 pack	2 / pack	1	108	
15800	white	800 sheet / Roll	23 x 22 cm	1 pack	6 / pack	1	36	
15895	white	1000 sheet / Roll	21 x 21 cm	1 pack	6 / pack	1	40	

Udder Paper StimuClean

- massages and stimulates, preferably dry • can also be used damp (not wet) • prevents transmission of germs
- especially absorbent (start with max. 3 litres of cleaning solution) • with cardboard core



Ref. no.	Colour	Contents	Sheet dimensions (L x W)			€
15798	grey	2 x 780 sheet / Pack	24 x 20 cm	1	66	

UdderoClean Bag

- practical solution for the storage of cut udder paper • easy and fast removal of individual sheets • no unnecessary back and forth at the milking station • with a collection bag for used udder paper • ideal for large livestock • Belt length easily adjustable • water-resistant material
- incl. two straps for fastening dip cups • suitable for wet and dry paper
- suitable for Kerbl udder paper cut 15851 • with click-closure



Ref. no.	Description	Colour	Length	Width	Height		€
15860	Belt bag with Collection Bag	black	26 cm	12 cm	16 cm	1/50	
15861	Collection Bag	black	12 cm	20 cm	28 cm	1/50	

Udder Paper UdderoClean

- cut • ready for use straight away and thus time-saving • easy and fast removal of individual sheets • high-wet-strength and lint-free
- stimulating effect via the crepe structure • suitable for Kerbl belt bag 15860 • 100 % virgin pulp • moist • 100 % biodegradable



Ref. no.	Colour	Contents	Sheet dimensions (L x W)	MOQ	Pieces / unit			€
15851	white	3 x 250 sheet / Pack	26 x 21 cm	3 pack	3 / box	1/3	162	

Udder Paper moist

- stimulating effect via the crepe structure • ready for use straight away and thus time-saving • strong cleaning effect via selected raw materials • 100 % virgin pulp
- food safe • QAC-free



100 % biodegradable

Ref. no.	Colour	Contents	Sheet dimensions (L x W)	MOQ	Pieces / unit			€
15817	white	800 sheet / Bucket	20 x 20 cm			1	72	
15818	white	800 sheet / Refill Pack	20 x 20 cm	2 pieces	2 / box	1/2	168	

Udder Cloth moist

- for external use only • Udder Cleaning • Stimulation of milk production • Milking time reduction • Milker's hand cleaning • Material: Non-woven fabric • QAC-free



recommended by farmers!



Ref. no.	Colour	Contents	Sheet dimensions (L x W)	MOQ	Pieces / unit			€
15815	white	1000 sheet / Bucket	20 x 20 cm	2 pieces	2 / box	1/2	48	
15816	white	1000 sheet / Refill Pack	20 x 20 cm	2 pieces	2 / box	1/2	60	

Udder Cloth UdderoClean Super

- reusable cloth for cleaning udders and reducing bacteria levels
- machine washable and can be boiled to 95 °C • Material: Non-woven fabric





washable and boil-proof

Ref. no.	Colour	Contents	Sheet dimensions (L x W)			€
15666	white	50 sheet / Pack	37 x 34 cm	1/6	72	
15667	white	50 sheet / Pack	29 x 27 cm	1/8	128	

Dispenser for udder paper

- for (udder) paper rolls with centre pull • cover made from sturdy plastic housing (ABS)
- with transparent and lockable cover • with integrated tear-off edge • easy wall mounting
- fits Kerbl UdderoClean udder paper (800 and 1000 sheets) and UdderoClean Air Premium (350 sheets) • supplied without paper



Ref. no.	Colour	Width	Depth	Height	Weight			€
15790	black	250 mm	358 mm	255 mm	1.200 g	1/4	32	

Holder for udder cloth bucket

- for flexible attachment of the dispenser bucket at the milking station
- suitable for bucket 15817 (cleaning paper, moist) and 15815





Ref. no.	Material			€
15823	stainless steel	1/10	80	

Wall Roll Holder

- for cleaning rolls and udder paper up to 40 cm width • Supplied without plaster rolls • folding
- for wall mounting





Ref. no.	Colour	Material			€
29563	blue	metal painted	1	90	

Udder Wood Wool

Pure natural product made from untreated wood! Only the best spruce and pine from Germany is used for udder wood wool. This makes our product very fine quality and gentle on the udder!

- guaranteed to be free from wood preservatives • single-use, economical and hygienic • low-cost
- simple, fast and very gentle udder cleaning • massage effect for good stimulation before milking
- suitable for all livestock farming • colour and structural variations are possible as wood is a natural materials, this is not a quality defect! • 100 % natural

100 % natural

Ref. no.			€
15821	1	16	



Indicator Paper

- is used to quickly identify secretion disorders that are often a sign of the onset of udder diseases • the paper has been prepared with a special indicator substance on four spots, marked according to the udder quarters • the corresponding indicator points must be moistened with milk of the first jets of each teat canal.

Ref. no.	Contents		€
1535	25 sheet / Pack	1/500	



SHOOF Mastitis Tester Original

- the X-Spurt tester makes mastitis testing a quick and efficient matter
- a short press on the X-Spurt handle, which also serves as a reservoir for the test fluid, sends an equal measure of test fluid into all four test areas at the same time, the samples then mix with the test fluid thanks to the tester's circular movements • 300 ml test fluid in the holder is enough to test around 15 cows



Ref. no.	Colour		€
15132	white	1/66	

Schalm test disk

- for California mastitis testing • one milk sample (approx. 2 ml) is added to each well, each from one udder quarter



Ref. no.	Colour		€
1513	white	1/10/100	
15131	black	1/10/100	

Pre-milk Cup

- for checking the first milk streams from each teat • with black plate



Ref. no.	Colour		€
1529	green	1/100	

Pre-milk Cup Ambic

- with a sieve insert • for checking the first milk streams from each teat • made of robust plastic • anti-spray insert



Ref. no.	Colour		€
15658	blue	1/60	

Teat Pens Silicon

• soft teat tips made of bio-compatible silicon • simple and hygienic insertion into the teat thanks to the handle section

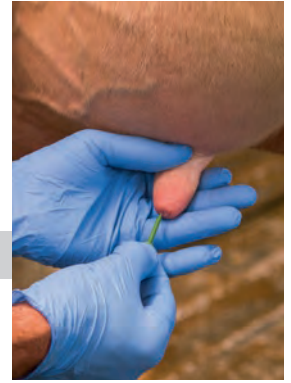

flexible & sterile

Ref. no.	Colour	Material	Contents		€
15659	green	Silicon	20 pieces / Can	1/10/250	

Teat tips

• for immobilising injured teats • the new teat insert is similar to the naturally occurring sebum and therefore, according to scientific tests which have been carried out, does not damage the teat canal
 • does not contain drugs and there is no waiting time • the wax-like consistency adapts to the teat canal
 • bonding or scarring of the teat canal is prevented • malleable at body temperature (does not dissolve)
 • can be milked out of the teat canal if necessary





No waiting time.

Ref. no.	Colour	MOQ	Pieces / unit		€
1566	white	1 blister pack	6 / blister pack	1	

Wool Teat Plug Uddero Dil

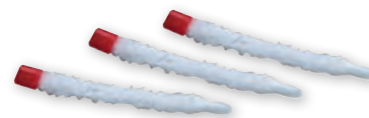
• with pearl • with Vaseline as a lubricant • for insertion into the teat canal in the case of milk duct strictures, damaged teats and after surgery



Ref. no.	Colour	Material	Contents	MOQ	Pieces / unit		€
1554	white	Cotton	20 pieces / Can	10 pieces	10 / box	1/10/300	



Wool Teat Plug with ointment

• with Vaseline as a lubricant • for insertion into the teat canal in the case of milk duct strictures, damaged teats and after surgery



Ref. no.	Colour	Material	Contents		€
1523	white	Cotton	20 pieces / Can	1/10/300	

Dilation Plug

• teat plugs with reinforced woollen thread • Length: approx. 5.5 cm • in split chamber vessel with Vaseline® each 20 in number • has a dilatatory and suction effect • for insertion in the milk duct • after injury or operations to prevent teat duct constriction

Ref. no.	Colour	Contents		€
1565	red / white	20 pieces / Can	1/6/504	



Teat cannula

• Teat cannulas keep the teat canal open • for injuries to teats or teat tips, surgical widening of the milk duct

Ref. no.	Material	Contents		€
1537	Plastic	10 pieces / Can	1/12/1.008	



Dip Cup Standard

- splash guard with outflow into an overflow chamber prevents spilling and wastage of the dip
- also suitable for viscous dips thanks to wide suction hose
- reservoir with measuring scale
- with practical belt hook

Ref. no.	Colour	Capacity			€
15656	green	300 ml	1/20	640	

Dip Cup Non-Return



A backstop in the interior of the attachment prevent used dip running back into the reservoir – hygienic, practical, safe! The dip is discarded after use and the dip cup can be refilled with new dip by pressing the reservoir.

- splash guard with outflow into an overflow chamber prevents spilling and wastage of the dip
- also suitable for viscous dips thanks to wide suction hose
- reservoir with measuring scale
- with practical belt hook

Ref. no.	Colour	Capacity	Attachment capacity			€
15652	green	300 ml	30 ml	1/20	640	



Dip Sprayer Uddero Sprayer

- high-quality spray head with metal nozzle
- specially angled spray nozzle for optimum teat cleaning and spot-accurate dipping
- with dual valve technology without pressure drop after a pause in spraying
- only use sprayable dipping agents
- chemical-resistant

Ref. no.	Colour	Capacity			€
15256	blue	500 ml	1/25	400	



Dip Sprayer Angular

- targeted teat cleaning and precise dipping thanks to specially angled nozzle
- Nozzle can be freely adjusted between spray jet to direct jet
- only use sprayable dipping agents
- chemical-resistant

Ref. no.	Colour	Capacity			€
15250	green	500 ml	1/25	400	

Dip Sprayer with teat cup

- targeted teat cleaning and precise dipping thanks to specially angled nozzle with upwardly angled teat cup
- Nozzle can be freely adjusted between spray jet to direct jet
- only use sprayable dipping agents

Ref. no.	Colour	Capacity			€
15252	green	500 ml	1/20	320	

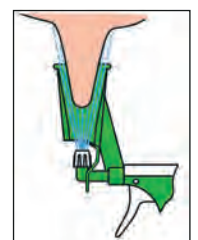
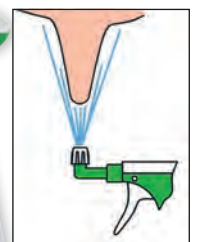

Udder Care Products CareMINT

- contains peppermint oil with cooling effect for improved blood circulation
- unique formulation thanks to the addition of high-quality tea tree and calendula oils
- the synergistic effect of the ingredients yields maximum care results for teats and udders exposed to daily stresses
- daily use can improve the resilience of skin and tissue in a completely natural way
- when used regularly, can have a positive influence on maintaining the health of udders and the production of high-quality milk
- simultaneously cleans the udder and provides care to support therapy



Top Seller

FIBL listed - recommended for organic operators



Ref. no.	Contents			€
15311	1000 ml / Hanging Bottle	1/6	192	



Udder Gel

- washable care balm with a gel-like consistency
- vegetable oils give the udder tissue effective protection and care
- promotes milk generation and ensures a fast milk flow
- prevents dry, chapped skin and keeps muscles and tendons soft and supple



Top Seller

with high-quality essential oils



Ref. no.	Contents			€
1520	500 g / Can	1/12	600	
1521	1000 g / Can	1/6	396	
15215	2500 g / Bucket	1/4	168	

EUTRA Milking Fat

- for better milk quality and profitability in dairy farming
- for the natural care of teats and udders

The genuine Swiss milking grease!



Ref. no.	Contents			€
1516	250 ml / Can	1/6	1.344	
1517	500 ml / Can	1/6	720	
1518	1000 ml / Can	1/6	720	
1519	2000 ml / Bucket	1/4	216	
15211	5000 ml / Bucket	1/2	70	
15212	10 L / Bucket	1	55	

Wound care spray

to support self-healing

- ready-to-use spray • promotes fast self-healing with superficial injuries and skin lesions • Wounds dry faster therefore heal faster • scabbed skin lesions are kept silky smooth and any itching that develops during the healing process is kept at bay • the resulting protective film prevents the wound from re-opening allowing it to heal completely • approved for all animals kept for food production • not subject to regulations on residue levels • spray on the affected areas 1-2 times a day for up to 1 week • suitable for all working animals



Please note the use and safety instructions.

with mint oil and allantoin

Ref. no.	Contents			€
15239	500 ml / Spray bottle	1/12	480	

Teat Bandage UdderoSoft

- does not stick to the skin or wound • self-adhesive, soft and elastic

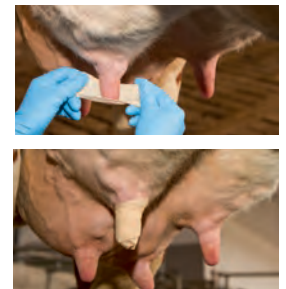



double sided protective film for better hygiene

Ref. no.	Colour	Length	Width		€
15660	beige	5 m	6 cm	1/50	

This product was specially developed to treat large animals and is only for use in veterinary medicine/hoof and claw care.

Teat Protector

- proven design • for protection against teat injuries in the pasture and in narrow stalls • this net is also a valuable aid in mastitis treatment • all you have to do when milking is open the hook

Ref. no.	Size			€
151	M	1/10	100	
152	L	1/10	100	
153	XL	1/10	100	



Teat Protector with neck strap

- chest and neck strap for additional support and proper fit on the cow • this teat protector limits teat injuries that can happen quickly in too narrow a stable or on the pasture • also ideal for the prevention of impact injuries

Ref. no.	Size		€
1567	M	1/10	
1568	L	1/10	
1569	XL	1/10	





Hand Cleaner with Cleansing Beads

Liquid hand cleaner for moderate to severe soiling caused by oil, grease and lubricant in industry, workshops and agriculture:

- contains skin-friendly, mild cleaning and care substances with high-quality moisturising agents
- with skin-friendly cornmeal scrubbers
- without microplastic
- does not clog drains
- pH value adapted for human skin
- silicone-free, solvent-free, soap-free
- dermatologically tested



Ref. no.	Contents			€
151193	500 ml / Bottle	1/10	900	
151194	2500 ml / Bottle	1/6	216	
151195	2500 ml / Bottle with Metering Pump	1/6	216	

New product

NEW

irritation-free
according to skin test





Ref. no.	Description		€
151187	Wall Mount for 2500 ml bottle	1/6/24	
151188	Dispensing Pump for 2500 ml bottle	1/96	

Hand-wash Paste

- with special wood flour (no sand)
- lightly fragranced
- high and particularly mild cleaning power
- with skin-friendly, environmentally neutral natural friction agents
- pH value adapted for human skin
- extremely economical to use
- does not clog drains
- Applications: for moderate to severe soiling caused by all kinds of dirt, such as oil, grease, lye, lubricants, etc.
- silicone-free, solvent-free, soap-free



Ref. no.	Contents			€
151170	500 ml / Can	1/24	720	
151171	5000 ml / Bucket	1	90	
151172	10 L / Bucket	1	44	

irritation-free
according to skin test



Hand Wash Brush

- the perfect hand-washing brush for heavy soiling
- robust plastic back
- with a row of strong polyester bristles
- Bristle length: 1 cm

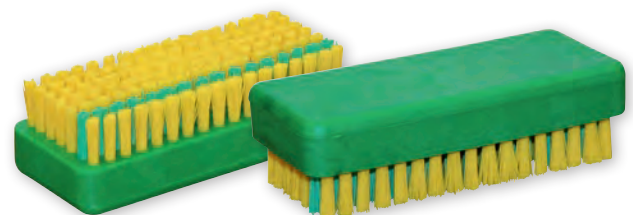



Ref. no.	Colour	Length	Width	Height		€
29183	green / yellow	10,5 cm	4,5 cm	3 cm	1/30	

Soft Soap Edelweiß

The alternative to products that harm the environment and very expensive specialist cleaning products. Protects the environment from phosphates, silicates, carbonates, sulphates, bleaching agents, enzymes and much more as a result. Contains only easily degradable raw washing products.

- Universal application for rinsing, washing and cleaning • for the gentle cleaning of textiles, tiles, stone and PVC flooring, paintwork, glass, enamel and much more
- can also be used as a washing detergent up to 60 °C • environmentally compatible
- phosphate-free, formaldehyde-free





Ref. no.	Contents			€
151175	1000 ml / Can	1/16	480	
151176	5000 ml / Bucket	1	90	

Paper Towel Roll

- extremely absorbent • glued • also suitable for udder cleaning
- food safe





Ref. no.	Description	Colour	Contents	Sheet dimensions (L x W)	MOQ	Pieces / unit			€
29560	2-ply	blue	1000 sheet / Roll	36 x 22 cm	1 pack	2 / pack	1	60	
29562	3-ply	blue	500 sheet / Roll	36 x 36 cm	1 pack	2 / pack	1	36	

Wall Roll Holder

- for cleaning rolls and udder paper up to 40 cm width • Supplied without plaster rolls • folding • for wall mounting



Ref. no.	Colour	Material			€
29563	blue	metal painted	1	90	

Dispensing Pump

- for 1-litre bottles and canisters with approx. delivery volume of approx. 4 ml
- suitable for Domo-Ultra and Domo-Mild from GEA • Material: Plastic

Ref. no.	Flow volume	suitable for Ø opening		€
151810	4 ml	25 mm	1/250	



Dispensing Pump

- made from a special, oil-resistant plastic • enables exact and safe emptying and refilling of chemicals and commercially available lubricating oils • incl. adapter for 5, 10 and 30 litres
- for DIN42, DIN51, and DIN61 threads

Ref. no.	Flow volume		€
151811	30 ml	1/40	

Dispensing Pump

- for canister with stainless steel spring • for dosing cleaning and dip media • made from stable and durable plastic • enables exact and safe emptying and refilling of chemicals
- with grey nut • Material: Plastic

Ref. no.	Description	Flow volume	suitable for Ø opening		€
151812	for 5 - 12.5 kg canisters	30 ml	51 mm	1/100	
151813	for 20 - 40 kg canisters	30 ml	61 mm	1/100	



Dispensing Pump

- suitable for 10 - 250 ml pumps • suitable for 1-litre bottles of milk cell test reagent N from GEA • with rotating valve • Material: Polypropylene

Ref. no.	Flow volume	suitable for Ø opening		€
151868	3 ml	28 mm	1/500	



Dispensing Pump Profi

- fixed drain with child lock • Double-acting stroke with large delivery volume
- for viscous dip media • Material: Plastic

Ref. no.	Description	Flow volume	suitable for Ø opening		€
151814	for 20 - 40 kg canisters	400 ml	61 mm	1/20	



Ref. no.	Description		€
151837	Valve Set for metering pump	1/100	



Barrel Pump Profi

- Professional drum pump, long design • with a fixed outlet and lock to prevent accidental operation (child safety lock) • Double-acting stroke with large delivery volume • resistant to many chemicals such as oils, acids, lyes, chlorine-based fluids and resin-containing agents • also pumps products with a higher viscosity, for example, molasses • with rotatable anti-drip drain valve • Material: Polypropylene

Ref. no.	Description	Flow volume		€
151818	for 100 - 220 litre barrels with 2 adapters (55 mm & 69 mm)	400 ml	1/10	

High volume -
low pressure - lighter flow

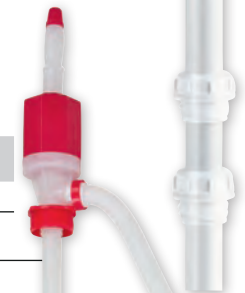

Barrel Pump With Hose

- for cleaning agents • with 2 adapters (55 mm and 69 mm) • Material: Plastic

Ref. no.	Description	suitable for Ø opening		€
151817	for 200 litre barrels	55 mm	1/32	



Canister Drain Valve

- for quick and safe emptying and refilling of chemicals from horizontal canisters and barrels
- Material: Plastic

Ref. no.	Description	suitable for Ø opening	MOQ	Pieces / unit		€
151819	for 5 - 12.5 kg canisters	51 mm	2 pieces	2 / pack	1/2/250	
151820	for 20 - 40 kg canisters	61 mm	2 pieces	2 / pack	1/2/200	

Ref. no.	Description	MOQ	Pieces / unit		€
151829	Reducer for outlet valves	2 pieces	2 / pack	1/2/250	



Rinser Anka

• with hose connection • Variable adjustable spray or concentrated jet • high water flow • Material: Nylon fibre-glass reinforced • use before max.: 7 bar

151874: Water flow 25 l/min

151873: Water flow 90 - 115 l/min

151874



151873

Ref. no.	Connection	Colour			€
151874	3/4"	green / black	1/100	2.000	
151873	1"	green / black	1/80	2.000	



151876



151875

Ref. no.	Description	Colour	Material		€
151876	Hose Connector 3/4"	black	Plastic	1/10/500	
151875	Hose Connector 1"	black	Plastic	1/10/320	

Rinser Super Jet

• with hose connector • Variable adjustable spray or concentrated jet
• flow rate regulated separately • suitable for water temperatures up to 35 °C • Material: Plastic with anti-slip coating • Water flow rate: 50 L/min • use before max.: 4 - 6 bar

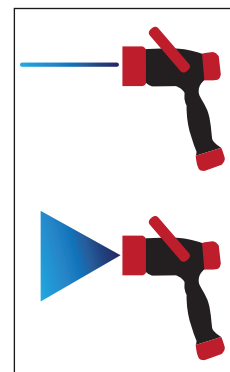

Ref. no.	Colour			€
151871	black / red	1/12	360	

Rinser Twist Jet

• with hose connector • Variable adjustable spray or concentrated jet • suitable for water temperatures up to 35 °C • Material: Plastic with anti-slip coating • Water flow rate: 38 - 47 L/min • use before max.: 4 bar

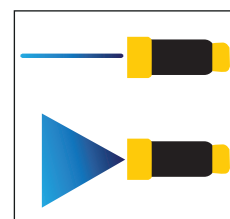

Ref. no.	Colour			€
151872	yellow / black	1/25	750	

Cleaning shower with crash bars

• brass interior • crash bars made from sturdy plastic • Variable adjustable spray or concentrated jet • suitable for water temperatures up to 50 °C • 1/2" internal thread, rotatable • Material: Plastic • Water flow rate: 50 L/min • use before max.: 12 bar

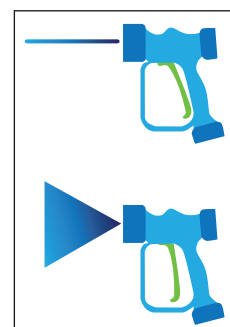

Ref. no.	Colour		€
151870	blue	1/10	

Spray Shower orig. Gilmour

- suitable for hot and cold water • Housing made from cast metal
- with insulated handle • Lever fixing for continuous spraying
- Stainless Steel Spring • self-adjusting anti-drip seal • incl. hose coupling (15732)



Ref. no.	Description	Colour			€
1573	with plastic insert	green	1/12/24	864	
1574	with brass insert	red	1/12/24	864	



Ref. no.	Description	Colour	Material		€
15731	Hose Connector 3-tier	black	Plastic	1/10/500	
15732	Hose Coupling	black	Plastic	1/10/500	

Spray Guns with accessories

- original Gilmour shower (with brass insert) • incl. accessories (3-metre, 1/2" water hose, hose jacket, hose clamp)



Ref. no.	Colour			€
151808	red	1/10	160	

Spray Rinser Komfort

- high quality metal spray shower • non-slip and abrasion-resistant surface for comfortable and fatigue-free working • steplessly adjustable nozzle from full jet to fine mist • incl. 3-step hose connection and standardised hose coupling (1.2")



Ref. no.	Connection			€
15741	1/2"	1/24	792	



Ref. no.	Description	Colour	Material		€
15731	Hose Connector 3-tier	black	Plastic	1/10/500	
15732	Hose Coupling	black	Plastic	1/10/500	

Foam Lance ST-73 with bottle

• corrosion-resistant injector made fully from stainless steel • high chemical resistance • 5 defined dosing positions • 2 litre capacity • a vertical and horizontal spray pattern • patent-pending • max. 250 bar / 80 °C • 1/4" IG



Ref. no.		€
151798	1/10	

The 1-litre bottle (art. 151807) for disinfectants is available as an option!

Accessories for foam lance



Ref. no.	Description	Material	can be used for		€
151807	Bottle for Foam Lance, 1 litre	Plastic		1/20	
151800	Manual screw attachment, 1/4" OT x 28 mm		Kärcher and Kränzle Professional High-Pressure cleaners	1/20	
151801	Rotary screw attachment ST-146, M 22 IT x 1/4" OT		Kärcher Professional High-pressure Cleaner	1/20	
151803	Plug nipple, 1/4" OT	stainless steel	Nilfisk / Alto, Ehrle and Kränzle high-pressure cleaners	1/20	
151802	Counter-nipple, M22 OT x 1/4" OT	brass	for all common high-pressure cleaners	1/20	

Milking and washing apron

• premium quality • ideal for all work related to agriculture, house and garden • high quality plastic • waterproof • extremely tear and kink-proof • Temperature resistance: -25 - 70 °C



Ref. no.	Colour	Length	Width		€
15147	blue	120 cm	80 cm	1/20	
15151	blue	125 cm	100 cm	1/20	
15153	blue	125 cm	125 cm	1/20	
15148	white	120 cm	80 cm	1/20	
15150	white	125 cm	100 cm	1/20	
15149	green	120 cm	80 cm	1/20	
15152	green	125 cm	100 cm	1/20	

Milking and washing apron PU

- ultra-lightweight and durable work apron made from polyurethane
- ideal for working in the stable, garden or home
- easy to adjust the required length with a plastic click fastener
- ultra-tear-resistant and shape stable
- temperature-resistant
- waterproof



Composition

Textile	100 % Polyester
Coating	100 % polyurethane

Ref. no.	Colour	Length	Width		€
15286	blue	120 cm	80 cm	1/80	
15288	blue	125 cm	100 cm	1/80	

Milking and washing apron MaxiMove

- high freedom of movement thanks to a separated and overlapping leg area
- ideal for all work related to agriculture, house and garden
- easy to adjust the required length with a plastic click fastener
- temperature-resistant
- waterproof



Composition

Coating	100 % PVC
---------	-----------

Ref. no.	Colour	Length	Width		€
15620	blue	120 cm	80 cm	1/20	
15621	blue	125 cm	100 cm	1/20	

Hygiene Sleeve Protector

The tight-fitting wrist cuff makes sure that no water, etc. can get into the sleeve protector. Scissors can be used, if necessary, to quickly shorten the cuff to customise the fit.

- extremely tear- and abrasion-resistant
- material resistant to cleaning agents
- waterproof (> 3000 mm water column)
- flexible in the cold, at down to -20 °C
- can be sterilised and disinfected
- detectable
- with elastic
- Temperature resistance: -20 - 95 °C
- food safe
- in pairs
- machine washable at 95 °C



Composition

Textile 100 % Polyurethane (TPU)



Ref. no.	Colour	Size	Length		€
15609	light grey	S / M	50 cm	1/20	
15610	light grey	L / XL	50 cm	1/20	

Size S/M is ideal for wrists greater than 14 cm in diameter. Size L/XL is ideal for wrists greater than 18 cm in diameter. You can cut to fit with scissors.

Disposable Protective Sleeve

- elasticated strap at both ends
- tear-resistant
- 0,03 mm
- Material: polyethylene



Ref. no.	Colour	Length	MOQ	Pieces / unit		€
15397	blue	45 cm	1 pouch	100 / pouch	1/10	

Protective Sleeve Softshell

- Oversleeves made from elastic softshell material
- practical with thumb holes to prevent slipping
- one size with drawstring to the upper arm for flexible fixing
- extremely water-resistant up to a 3000 mm water column
- breathable to 1000 g/m²/24 h
- in pairs

Composition

Textile 100 % Polyester

Ref. no.	Colour	Length		€
15388	dark blue	54 cm	1/80	



Protective Sleeve Oxford

- high-quality oversleeves made from the finest Oxford polyester
- waterproof and breathable thanks to their special coating
- elasticated strap at both ends
- in pairs

Composition

Textile 100 % Polyester

Ref. no.	Colour	Length		€
15387	blue	40 cm	1/80	



Protective Sleeve

- 100 % watertight
- with elastic waist
- Temperature resistance: -25 - 70 °C
- in pairs

Composition

Textile 100 % PVC

Ref. no.	Colour	Length		€
15385	blue	40 cm	1/20	



Disposable glove Nitrile Premium

- especially suitable as milking gloves • 30 cm long for comfortable protection • for the toughest conditions • ambidextrous • non-sterile • tested according to: EN 374/1 (protection from chemicals and micro-organisms) • free from allergy inducing thiurames, thiazoles and latex proteins, latex-free, Free of powder • 1.5 AQL (quality standard)
- Weight size M: 12 - 13 g/piece • food safe



EN ISO 374-1:2016
Type B



JKT

Ref. no.	Colour	Size	Length	Material thickness	MOQ	Pieces / unit			€
15325	light blue	6.5-7 / S	30 cm	8 mil = 0,2 mm	1 pack	50 / pack	1/20	300	
15326	light blue	7.5-8 / M	30 cm	8 mil = 0,2 mm	1 pack	50 / pack	1/20	300	
15327	light blue	8.5-9 / L	30 cm	8 mil = 0,2 mm	1 pack	50 / pack	1/20	300	
15328	light blue	9.5-10 / XL	30 cm	8 mil = 0,2 mm	1 pack	50 / pack	1/20	300	
15329	light blue	10.5-11 / XXL	30 cm	8 mil = 0,2 mm	1 pack	50 / pack	1/20	300	

Disposable glove Nitrile Profi

- 30 cm long for comfortable protection • for the toughest conditions • ambidextrous
- non-sterile • tested according to: EN 374/1 (protection from chemicals and micro-organisms)
- latex-free, Free of powder, free from allergy inducing thiurames, thiazoles and latex proteins
- 1.5 AQL (quality standard) • Weight size M: 11 - 12 g • food safe



EN ISO 374-1:2016
Type B



KTPS

Ref. no.	Colour	Size	Length	Material thickness	MOQ	Pieces / unit			€
15380	blue	6.5-7 / S	30 cm	8 mil = 0,19 mm	1 pack	50 / pack	1/20	360	
15381	blue	7.5-8 / M	30 cm	8 mil = 0,19 mm	1 pack	50 / pack	1/20	360	
15382	blue	8.5-9 / L	30 cm	8 mil = 0,19 mm	1 pack	50 / pack	1/20	360	
15383	blue	9.5-10 / XL	30 cm	8 mil = 0,19 mm	1 pack	50 / pack	1/20	360	
15384	blue	10.5-11 / XXL	30 cm	8 mil = 0,19 mm	1 pack	50 / pack	1/20	360	

Disposable glove Nitrile Long Black

- 30 cm long for comfortable protection • fully textured, therefore providing excellent grip • especially suitable as a milking glove: white flakes in the milk, a sign of mastitis, can be detected more easily on the black background
- ambidextrous • non-sterile • tested according to: EN 374/1 (protection from chemicals and micro-organisms) • free from allergy inducing thiurames, thiazoles and latex proteins, latex-free, Free of powder • 1.5 AQL (quality standard) • Weight size M: 7,7 - 8 g • food safe



EN ISO 374-1:2016
Type B





KTPS

Ref. no.	Colour	Size	Length	Material thickness	MOQ	Pieces / unit			€
15320	black	6.5-7 / S	30 cm	5,5 mil = 0,14 mm	1 pack	50 / pack	1/20	360	
15321	black	7.5-8 / M	30 cm	5,5 mil = 0,14 mm	1 pack	50 / pack	1/20	360	
15322	black	8.5-9 / L	30 cm	5,5 mil = 0,14 mm	1 pack	50 / pack	1/20	360	
15323	black	9.5-10 / XL	30 cm	5,5 mil = 0,14 mm	1 pack	50 / pack	1/20	360	
15324	black	10.5-11 / XXL	30 cm	5,5 mil = 0,14 mm	1 pack	50 / pack	1/20	360	

GEA Wall bracket for disposable gloves

- made from stainless steel: heavy-duty and rust-free, even in wet conditions (e.g. in the milking station)
- screw-on fastening
- can be affixed vertically and horizontally
- stable position and suitable for all sizes thanks to spring that pushes the dispenser box to the front



Ref. no.	Customer no.	Material			€
15339-GEA	7315-5151-700	stainless steel	1/8	192	

Disposable glove Nitrile Classic

- ambidextrous
- non-sterile
- free from allergy inducing nitrosamines, thiurames, thiazoles and latex proteins, latex-free, Free of powder
- 1.5 AQL (quality standard)
- Weight size M: 5,6 - 5,8 g
- food safe



Ref. no.	Colour	Size	Length	Material thickness	MOQ	Pieces / unit			€
15370	light blue	6.5-7 / S	24 cm	4 mil = 0,1 mm	1 pack	100 / pack	1/10	360	
15372	light blue	7.5-8 / M	24 cm	4 mil = 0,1 mm	1 pack	100 / pack	1/10	360	
15373	light blue	8.5-9 / L	24 cm	4 mil = 0,1 mm	1 pack	100 / pack	1/10	360	
15374	light blue	9.5-10 / XL	24 cm	4 mil = 0,1 mm	1 pack	100 / pack	1/10	360	

EN ISO 374-1:2016
Type B





JKPT

Disposable glove Nitrile Basic

- ambidextrous
- non-sterile
- latex-free, Free of powder, free from allergy inducing nitrosamines, thiurames and thiazoles
- 1.5 AQL (quality standard)
- Weight size M: 3,3 - 3,5 g
- food safe



Ref. no.	Colour	Size	Length	Material thickness	MOQ	Pieces / unit			€
15330	blue	6.5-7 / S	24 cm	0,07 mm	1 pack	100 / pack	1/10	360	
15331	blue	7.5-8 / M	24 cm	0,07 mm	1 pack	100 / pack	1/10	360	
15332	blue	8.5-9 / L	24 cm	0,07 mm	1 pack	100 / pack	1/10	360	
15333	blue	9.5-10 / XL	24 cm	0,07 mm	1 pack	100 / pack	1/10	360	

Round-headed brush

- suitable for hygienic areas (HACCP) • heat-resistant up to: 140 °C • Bristle material: Polyester
- Material: Plastic

Ref. no.	Colour	Ø		€
151783	white	120 mm	1/5	



Can Brush

- with wide-set bristles • ideal for cleaning hard to reach places • Bristle material: Polyester • Material: Plastic

Ref. no.	Colour	Length		€
29177	white / blue	22 cm	1/10	

up to 100 °C heat-resistant

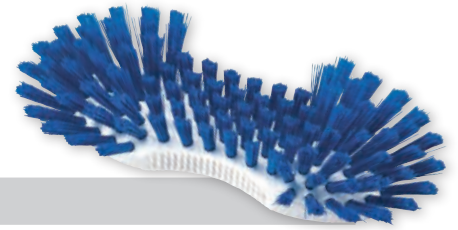

Washing brush

- suitable for hygienic areas (HACCP) • heat-resistant up to: 140 °C • Bristle material: Polyester • Material: Plastic

Ref. no.	Colour	Length		€
151784	white	20,5 cm	1/5	



Handle Brush

- with ergonomic plastic handle • suitable for hygienic areas (HACCP) • heat-resistant up to: 140 °C • Bristle material: Polyester • Material: Plastic

bristles heat-resistant to 140 °C

Ref. no.	Description	Colour	Length		€
29174	with long handle	white / blue	40 cm	1/5	
151780	with short handle	white	14 cm	1/5	



Universal and boiler brush

- Polypropylene bristles, medium hardness • Bristle thickness: 0,3 mm

up to 80 °C heat-resistant





Ref. no.	Description	Colour	Length	Width		€
29172	without handle	blue	200 mm	125 mm	1/10	

Ref. no.	Description	Length		€
29173	Fibreglass Handle	100 cm	1/20	
29182	Fibreglass Handle	145 cm	1/20	

Large scrubber

- bristles heat-resistant to 140 °C • suitable for hygienic areas (HACCP) • plug-in system with union nut • with PST bristles • with handle thread • matching handle: 29182

Ref. no.	Colour	Width			€
151781	white	40 cm	1/5	330	

Ref. no.	Description	Length		€
29182	Fibreglass Handle	145 cm	1/20	



Flexo Brush

- the flexible cleaning brush • Bristle material: Polypropylene
- Material: Plastic

Ref. no.	Colour	Length		€
29176	white	19 cm	1/10/100	

up to 80 °C heat-resistant

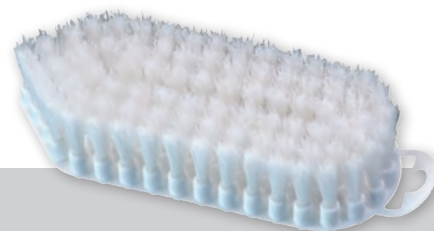

Cleaning and Scrubbing Brush

Scrubbing Brush

- wet-proof plastic back • Bristle material: Polypropylene

Ref. no.	Colour	Length		€
29178	beige	22 cm	1/30	

up to 60 °C heat-resistant

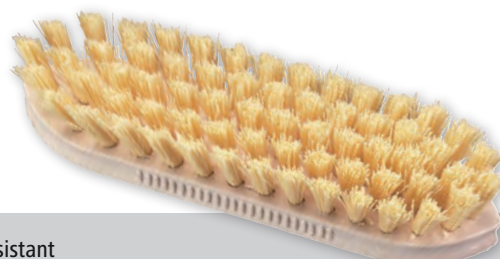

Washing brush

- Bristle material: Polyamide • Material: Plastic

Ref. no.	Colour	Length		€
2916	white	19 cm	1/50	

up to 60 °C heat-resistant



Double Brush

- with plastic handle for optimal hygiene

Ref. no.	Length	Ø		€
151830	40 cm	13 mm	1/200	



Pipe Brush

- with plastic handle for optimal hygiene

Ref. no.	Length	Ø		€
151831	62 cm	70 mm	1/100	

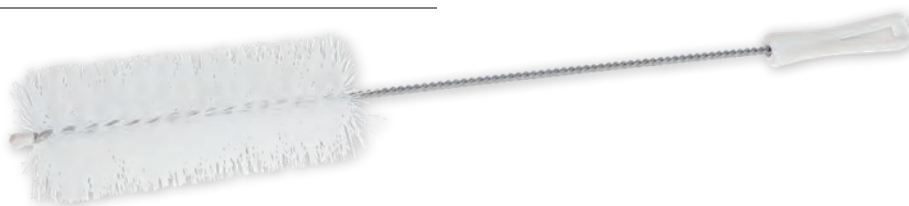

Hose Wiper

Ref. no.	Length		€
2914	155 cm	1/50	
2915	30 cm	1/200	

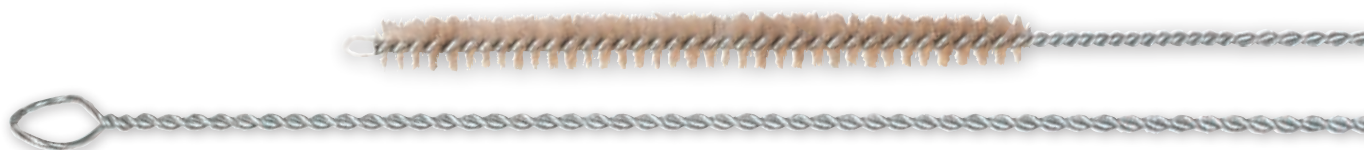

Teat Cup Brush

- 3-level bristle spiral • staggered bristle length to 59 mm diameter • Plastic Handle
- acid-proof • heat-resistant up to: 100 °C • Material: Plastic



Ref. no.	Length		€
151785	50 cm	1/50	

Teat Cup Brush

- with wooden handle • extremely hard-wearing

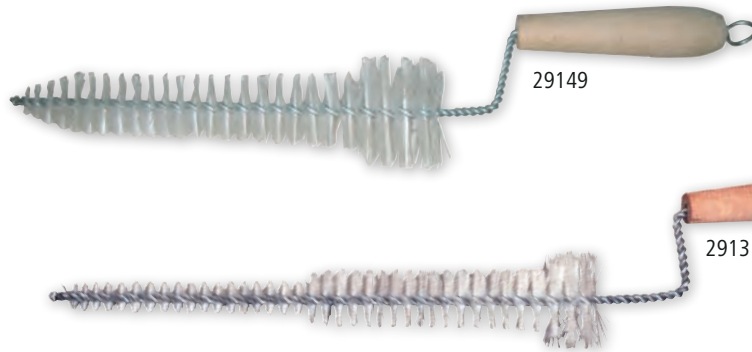

Ref. no.	Description	Length		€
2913	Bristle spiral 3-tier	50 cm	1/30	
29149	Bristle spiral 2-tier	40 cm	1/30	



Basin

- made from high-quality, pure polyethylene • extremely high cold impact strength • impact and shock-resistant • extremely acid-resistant • with smooth surfaces for easy cleaning • complete drainage through chamfered trough base • the outlet is fitted with a sieve and a drain connection piece • Wall bracket or table frame not included. • Material: polyethylene • shatter-proof • food safe
- with outlet

29414: up to max. 95 kg load capacity (mounted on wall brackets)
 29415: up to max. 150 kg load capacity (mounted on wall brackets)



temperature resistant from - 65 °C to + 85 °C

Ref. no.	Length	Width	Height	Capacity			€
29414	74 cm	62 cm	25 cm	65 L	1	100	
29415	100 cm	62 cm	28 cm	100 L	1	50	

Ref. no.	Description	Material	suitable for		€
29402	Wall Bracket	metal galvanised	29414	1	
29404	Wall Bracket	metal galvanised	29415	1	
29419	Table Frame	metal galvanised	29414	1	
29420	Table Frame	metal galvanised	29415	1	

Udder Hair Remover PREVENTA

- the Preventa removes udder hair quickly and painlessly using a "cold" flame (about 200 ° C) • the bent torch allows ergonomic working in an upright position • the well thought-out design of the device with its standby-lever guarantees a quick and safe use. • eliminates pathogens like bacteria and viruses completely • Mastitis and Johne's disease can be prevented • shortens preparation time before milking • hairless udders are easier to clean • improves the general udder hygiene

15676: Gas cartridge not included

- the contents are enough for approx. 2-3 operating hours (depending on consumption) • the supplied belt clip makes using the gas cartridge easy and time-saving

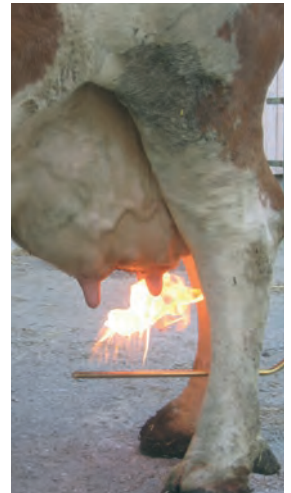
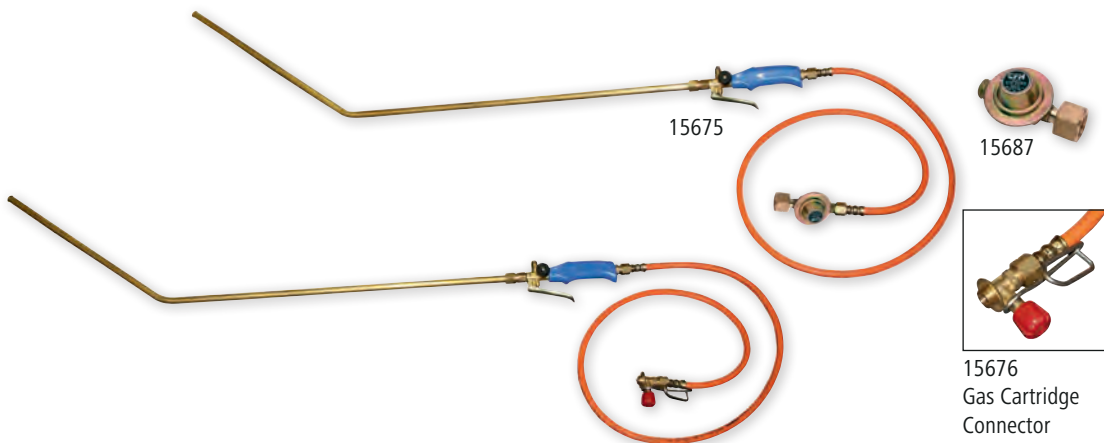

Ref. no.	Description	Lance length	Hose length		€
15675	with gas bottle connection and pressure reducer	100 cm	300 cm	1/50	
15676	with gas cylinder connection	100 cm	150 cm	1/50	

Ref. no.	Description	suitable for	Contents		€
15687	Pressure Reducer for gas bottle connection			1/20	
15683	Gas Cartridge Propane/butane	15676	600 ml	1/12	

TailWell2® Power Tail Trimmer II

The logical further development of the successful model from New Zealand!

- makes the arduous work involved with cutting hair on the tails of dairy cows easier • twice annual removal of cow tail hair that is contaminated with faeces and urine allows for optimal hygiene of livestock, milk and milker. • pre-cutting the hair is not necessary even in the case of heavy soiling or crusting. • works quietly and creates a smooth haircut in a maximum of 4 seconds per tail • Principle: It works on the principle of an outer blade rotating around an inner one, therefore there is no risk of injury to the animal or the operator • with a powerful battery, up to 200 tail shears with just one charge • the in-house developed grinding paste supplied allows for easy and simple grinding of the blades even by inexperienced users (necessary after 1000 to 2000 shears). • fits virtually all battery-powered screwdrivers operating at min. 14 Volt, 1,250 rpm (battery screwdriver not included) • supplied in a handy plastic case for safe storage • includes DVD and handbook



Ref. no.		€
18250	1/10	

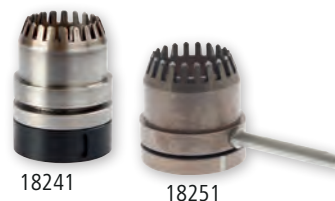

Ref. no.	Description	Contents		€
18251	Blade for Tail Trimmer II		1	
18252	Grinding Paste for Tail Trimmer		1	
1850488	Clipper Oil	100 ml	1/50/200	
18241	Blade for Tail Trimmer I (previous model)		1	

Sana Milk Filters Premium 120 g

- high-quality, food-safe nonwoven fabric • finest filtration • very high wet strength • especially suitable for large amounts of milk and the highest standards
- recommended for robotic milters • 120 g/m² • food safe • sewn



recommended for robotic milters

Ref. no.	Width	Length	Suitable for	MOQ	Pieces / unit		€
46783	44 mm	570 mm	DeLaval	1 pack	100 / pack	1/10	
46784	44 mm	1.044 mm	DeLaval	1 pack	100 / pack	1/8	
46786	78 mm	620 mm	Lely (Robotic Milker) / GEA / Boumatic / S.A.C.	1 pack	100 / pack	1/8	
46787	78 mm	1.125 mm	Lely (Robotic Milker)	1 pack	100 / pack	1/5	

Sana Disc Filters

- high-quality, food-safe nonwoven fabric • Suitable for: Milk Sieves

Ref. no.	Ø	MOQ	Pieces / unit		€
46752	115 mm	1 pack	200 / pack	1/60	
46753	120 mm	1 pack	200 / pack	1/60	
46754	125 mm	1 pack	200 / pack	1/60	
46755	140 mm	1 pack	200 / pack	1/60	
46756	160 mm	1 pack	200 / pack	1/35	
46757	170 mm	1 pack	200 / pack	1/35	
46758	180 mm	1 pack	200 / pack	1/30	
46759	190 mm	1 pack	200 / pack	1/30	
46760	200 mm	1 pack	200 / pack	1/30	
46761	220 mm	1 pack	200 / pack	1/30	
46762	240 mm	1 pack	200 / pack	1/10	
46763	270 mm	1 pack	200 / pack	1/10	



Sana Disc Filters with hole

- high-quality, food-safe nonwoven fabric • Suitable for: Milk Sieves

Ref. no.	Ø	MOQ	Pieces / unit		€
46770	220 mm	1 pack	100 / pack	1/30	
46771	300 mm	1 pack	100 / pack	1/10	



Milk Sieve stainless steel

- for use in cooling tanks and milk cans • suitable for Ø 170 mm cotton discs • all parts 100 % stainless steel • hygienic, hassle-free cleaning

New product

NEW

stainless steel

Included in delivery: 1 x milk sieve, 1 x coarse mesh, 1 x fine mesh, 1 x perforated panel, 1 x clamping ring

Ref. no.	Capacity		€
15182	10 L	1/5	

Ref. no.	Description	Material	Ø		€
151631	Sieve Insert Net	stainless steel	170 mm	1	
15183	Sieve Insert Perforated Disc	stainless steel	170 mm	1	
15184	Clamping Ring for milk strainer	stainless steel	170 mm	1	



Milking Sealing Plug conical

• for use with animals with three teats • conical shape with three-finger grip for easy insertion and removal • suitable for all teat cups

Ref. no.	Colour	Material	MOQ	Pieces / unit		€
151040	blue	Plastic	10 pieces	10 / pouch	1/10/200	



Milking Sealing Plug

• ideal for the milking machine, with animals with three teats • quickly solves the problem and adds cleanliness to milking • suitable for all teat cups

Ref. no.	Colour	Material	MOQ	Pieces / unit		€
2911	black	Plastic	10 pieces	10 / pack	1/10/150	
2911/1	black	Plastic	1 blister pack	1 / blister pack	1	



Universal Cleaning Sponge

• for cleaning pipelines in the food industry (milk, wine, delicatessen) • food safe

Ref. no.	Colour	Height	Ø	MOQ	Pieces / unit		€
4670	white	70 mm	40 mm	1 pack	10 / pack	1/100	
4671	white	70 mm	50 mm	1 pack	10 / pack	1/100	
4672	white	70 mm	60 mm	1 pack	10 / pack	1/80	
4676	white	80 mm	70 mm	1 pack	10 / pack	1/60	



Milk dummy cap

• for covering the teat cup • for safe and hygienic milking of three-teat cows

Ref. no.	Colour	Interior diameter		€
151804	yellow	57 mm	1/350	
151806	yellow	60,3 mm	1/350	
151805	yellow	63,5 mm	1/300	



Milking Stool

• with steel leg, coil spring and wooden seat • with adjustable polyamide straps for putting on • Seat height: 34 cm

Ref. no.		€
2910	1/10	



Which lid fits which bucket?



Here you will find an overview to help you find the right product.

You will find additional product information for the listed products on the following pages.





Milking Pail Stainless Steel

• without accessories • Material: stainless steel stainless • with metal carry handle

Ref. no.	Description	Capacity	Frame height			€
151001	short	25 L	117 mm	1	24	
151002	Standard	25 L	143 mm	1	24	

Milking Pail Plastic

• for daily use • can be used to check each individual cow's milk yield • also for mobile milking machines
 • suitable for systems made by popular brands (e.g. Westfalia) • Material: Polycarbonate • with metal carry handle
 • with double fill scale (kg; lb) • food safe

Ref. no.	Description	Colour	Capacity	Frame height			€
151050	Standard	red	30 L	143 mm	1	24	
151051	Standard	blue	30 L	143 mm	1	24	
151052	Standard	green	30 L	143 mm	1	24	
151055	short	blue	30 L	117 mm	1	24	
151056	short	green	30 L	117 mm	1	24	

Milking Pail Lid

- transparent polycarbonate - extremely durable and easy to clean
- flat design
- for Plastic and Stainless Steel Milking Pail 25/30 Litres



new flat shape as per QM milk standard

Ref. no.	Description	Material	Ø		€
151058	Supports ID 13 mm x AD 17 mm	Polycarbonate	205 mm	1/20	
151059	Supports ID 16 mm x AD 20 mm	Polycarbonate	205 mm	1/20	

Ref. no.	Description		€
151060	Rubber Seal for milking pail covers	1/26	

Stainless Steel Lid for milking pails

Stainless Steel Lid for Milking Pail 25/30 l with Mount for Pulsator Adapter (ADM 14 mm)

- connecting pieces 13 x 16 mm
- Rubber ring for stainless steel lid

151007: suitable for 151001, 151055, 151056

151009: suitable for 151002, 151050, 151051, 151052



Ref. no.	Description	Material		€
151007	suitable for pail with handle height 117 mm	stainless steel	1/10	
151009	suitable for pail with handle height 143 mm	stainless steel	1/10	



Ref. no.	Description		€
151006	Rubber Ring	1/100	

Milking Machine Oil Viscano

- Viscano stands out for its extraordinary viscosity at different outside temperatures
- this ensures that all brands of milking machines can be operated easily at both high and low ambient temperatures
- Viscano is characterised by high resistance to ageing as well as very good corrosion protection and anti-wear properties
- Viscosity at 40 °C: 68 mm²/s

Not suitable or approved for GEA systems!

ATTENTION: the relevant manufacturer's requirements must be met!

Ref. no.	Contents			€
1549	1 L / Bottle	1/12	480	
1570	5 L / Canister	1/3	90	
1555	10 L / Canister	1	40	



Rod thermometer

- with fastening thread • Probe length 38 cm • Measuring range 0 - 100 °C or 32 - 210 °F • food safe



Ref. no.	Material		€
141453	stainless steel	1/10	

Milk and Cheese Thermometer

- with hanging tab • Measuring range -10 °C - 110 °C • can be boiled

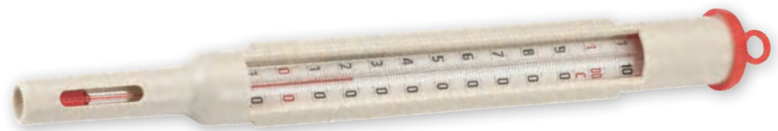



Ref. no.	Material		€
29144	Plastic	1/100	

Contains no mercury!

Measuring cup

- with handle and drain spout • stackable • Material: Polypropylene
- chemical-resistant, oil resistant • with measuring scale • food safe



Ref. no.	Colour	Capacity			€
291194	transparent	500 ml	1/200	1.600	
291195	transparent	1000 ml	1/120	960	
291196	transparent	2000 ml	1/60	480	

Waikato Milk measuring device

- 30 kg - Original Waikato
- Milk meters are an important aid for agriculture
- farmers can recognise high and low-performance animals early on with regular use of milk meters
- the milk meter stores a small percentage of the total yield in a calibrated container; the total amount can then be read from this
- also ideal for fat analysis
- ICAR-certified
- holder (157116) not included in supply
- with printed measurement scale

Ref. no.	Colour		€
15700	blue	1/6	

Ref. no.	Description		€
157116	Holder for milk meter	1/70	
15705	Mounting Bracket transportable	1/10	



157116



Quarter milker

- milk with an increased cell count or milk from an udder quarter contaminated with foreign substances can be milked separately
- extremely robust
- Easy to clean
- for milking machines up to 57 kPa
- with carrying handle

Ref. no.	Colour	Capacity		€
15902	white / blue	8 L	1/12	
15903	white / blue	12 L	1/12	

NEW



SHOOF Quarter Milker

- milk with an increased cell count or milk from an udder quarter contaminated with foreign substances can be milked separately with this product
- unbreakable
- Easy to clean
- with carrying handle

Ref. no.	Colour	Capacity		€
15701	white / blue	8 L	1/12	



15701



Battery-operated Horn Remover buddex

Proven Buddex technology in a new, ergonomic design!

- humane dehorning: The unique focal ring reliably prevents horn growth in animal-friendly way
- Temperature at the burner tip: The high temperature of 700 °C at the burner ring means that de-horning is carried out on the calf within a couple of seconds
- the heat-up phase only begins once pressed against the horn bud. There is no shaft that is fully heated, and so no burn risk for the user
- the Buddex heats up to 700°C in just 7 seconds!
- battery operation means maximum freedom of movement during de-horning - no cable clutter
- single-handed operation means that the calf can be kept still with the other hand
- with 230/12 Volt power pack
- Battery built-in



Up to 40 calves with a single charge!



Technical data	1790
max. heat-up time	approx. 4 sec
max. burning tip temperature	approx. 700 °C
Weight	800 g incl. battery



Made in Germany



Ref. no.	Colour	Length	Ø burning tip		€
1790	green	19,5 cm	18 mm	1/10	

Dehorner with transformer

- with 24 Volt safety transformer
- incl. stainless steel burner tip
- very high heat output and considerable reserve power of dehorning tip (heating cartridge is located inside the dehorning tip)
- easy handling due to light weight
- with ergonomic handle
- with stainless steel tray
- Material: stainless steel



Made in Germany





stainless steel

Technical data	17460
Voltage	24 V
Power	250 W
max. heat-up time	~ 11 min
max. burning tip temperature	620 °C
Length of burning rod	15,5 cm
Weight	630 g incl. cable
Cable length	4 m

17451

17452

Ref. no.	Colour	Length	Ø burning tip		€
17460	black	30 cm	18 mm	1	

Ref. no.	Description	Material	Ø		€
17455	Burning rod single 24 V / 250 W			1/30	
17451	Burning tip	stainless steel	18 mm	1/100	
17452	Burning tip	stainless steel	15 mm	1/100	

Dehorner GasBuddex

The professional tool for humane dehorning of calves. Fast heating up time and high maximum temperature of 650 °C make the GasBuddex a tool of the highest quality. Stainless steel finish guarantees durability and meets the highest expectations!

- pain-free to the greatest possible extent for a calf through a dehorning process of maximum 10 seconds long
- operating temperature of about 650 °C is reached within max. 3 minutes
- practical design through non-slip handle and balanced centre of gravity
- dependable, automatic Piezo ignition
- Material: stainless steel
- Gas included.
- includes operating instructions
- 2-year warranty



approx. 650 °C operating temperature

Technical data

max. burning tip temperature	approx. 650 °C
max. heat-up time	approx. 3 min
Duration of work	120 - 180 min
Weight	765 g

Included in delivery: 1 x dehorner, 2 x gas canisters (1756), 1 x spare tip, 1 x metal case, Tools

Ref. no.	Colour	Length	Ø burning tip		€
1730	green	31 cm	20 mm	1/6	
1731	green	31 cm	15 mm	1/6	

Ref. no.	Description	Ø	Contents		€
1738	Burning tip for GasBuddex	25 mm		1/10	
1732	Burning tip for GasBuddex	20 mm		1/10	
1733	Burning tip for GasBuddex	15 mm		1/10	
1734	Gas Nozzle for GasBuddex			1/10	
1756	Gas Cartridge		110 ml	1/12/72	



Soldering iron Direct connection

- incl. stainless steel burner tip
- very high heat output and considerable reserve power of dehorning tip (heating cartridge is located inside the dehorning tip)
- easy handling due to light weight
- with ergonomic handle
- with stainless steel tray
- Material: stainless steel



stainless steel

Technical data	17450
Voltage	230 V
Mains frequency	50 Hz
Power	210 W
max. heat-up time	approx. 11 min
max. burning tip temperature	620 °C
Length of burning rod	15,5 cm
Weight	630 g incl. cable
Cable length	3 m

Ref. no.	Colour	Length	Ø burning tip		€
17450	black	30 cm	18 mm	1/30	

Ref. no.	Description	Material	Ø		€
17451	Burning tip	stainless steel	18 mm	1/100	
17452	Burning tip	stainless steel	15 mm	1/100	



Gas Dehorner Portasol 3

- for fast and effective calf dehorning • gas-operated with fillable gas tank • robust stainless steel housing • easy to maintain thanks to the new dehorner assembly • newly developed, more robust burner head made of stainless steel • new ignition system with „click-ignition“ for easy reliable gas mixture ignition; Portasol 3 is manually ignited • supplied in sturdy plastic boxes • Gas not included. • includes operating instructions



approx. 600 °C operating temperature

Technical data	1752
max. burning tip temperature	approx. 600 °C
max. heat-up time	approx. 5 min
Duration of work	45 min
Weight	320 g



1753



Ref. no.	Length	Ø burning tip		€
1752	23,8 cm	18,5 mm	1/15	

Ref. no.	Description	Ø	Contents		€
17520	Burning tip	15 mm		1/100	
17521	Burning tip	18,5 mm		1/100	
1753	Gas Cartridge		200 ml	1/12	

Gas Dehorner D-Horn

- with 3-metre hose for connection to standard gas cylinders • robust design and light weight for long-term use • with brass dehorning tip • a pressure regulator (not included) is required for use • Gas not included.

Technical data	1721
max. burning tip temperature	approx. 610 °C
max. heat-up time	approx. 4 min
Weight	500 g



Ref. no.	Length	Ø burning tip		€
1721	33 cm	18 mm	1/30	



15687

Ref. no.	Description	Ø		€
1796	Burning tip	15 mm	1/25	
1797	Burning tip	18 mm	1/20	
15687	Pressure Reducer for gas bottle connection		1/20	



Hornstick

Pen for external application to calves

- for calves aged 1 to 4 weeks • several calves (approx. 4-5 depending on use) can be dehorned with one stick • incl. instructions

Ref. no.	MOQ	Pieces / unit		€
1713	5 pieces	5 / pack	1/5/500	

FOR EXPORT ONLY!
Please note the use and safety instructions.
Not approved for Germany and Austria!



Wire Saw according to Liess

- exclusively for dehorning • lightweight and easy to handle • Order wire saw handles separately • in plastic jar

Ref. no.	Description	Length		€
1714	in plastic jar	3,6 m	1/100	
17141	in plastic jar	12 m	1/100	

Ref. no.	Description		€
1715	Wire Saw Handle in pairs	1/100	



Aesculap Wire Saw

- extra strong wire saw for birth assistance and dehorning • professional quality from Aesculap • in plastic jar

Ref. no.	Length		€
VF676	10 m	1/200	



Dehorning Saw TECNALL with saw blade

- for dehorning adult cattle • consisting of angle sander, blade attachment and blade
- saw blade also perfect for wood as it has interlocking teeth

Technical data	1782
Voltage	230 V
Mains frequency	50 Hz
Power	2.400 W

Ref. no.	Colour		€
1782	yellow	1	

FOR EXPORT ONLY!

Ref. no.	Description		€
1781	Saw Blade for dehorner saw	1/10	
1772	Saw Attachment without saw blade	1/6	



Cooling Spray IceCool

- cooling spray for cold shock treatment • frozen locations are less sensitive to pain • for de-horning preparation • easy to use

Please note the use and safety instructions.

Ref. no.	Contents		€
15879	400 ml / Spray Can	1/12	



Cow weaning system Müller THE ORIGINAL

Made in Germany



Cattle Weaner Müller 2010

THE further refinement of the MÜLLER ORIGINAL

- additional tilting protection prevents calves, young or mature cattle from sucking in particular circumstances despite the calf weaner being worn on the udder
- it goes without saying that the existing advantages such as super-elastic material, easy adjustment wing nut and UV-stabilized plastic are included in the 2010 model



13151
for young and
mature cattle



13150
for calves and
young cattle



13152
for mature cattle

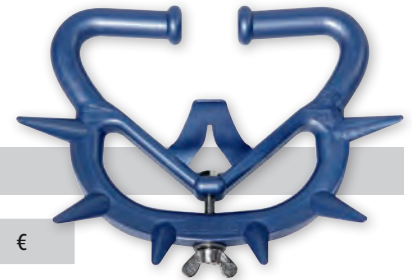

with additional tilting protection!

Ref. no.	Colour	Suitable for	MOQ	Pieces / unit		€
13150	red	Calves, Young cattle	6 pieces	6 / pack	1/6/210	
13150/2	red	Calves, Young cattle	1 blister pack 2 / blister pack		1/105	
13151	orange	Young and mature cattle	6 pieces	6 / pack	1/6/210	
13151/2	orange	Young and mature cattle	1 blister pack 2 / blister pack		1/105	
13152	blue	Livestock	6 pieces	6 / pack	1/6/210	
13152/2	blue	Livestock	1 blister pack 2 / blister pack		1/105	



Cattle Weaner Müller

- elastic material plus a screw ensure easy adjustment and thus proper fitting to the animal's nasal cartilage
- this weaner is impossible to lose

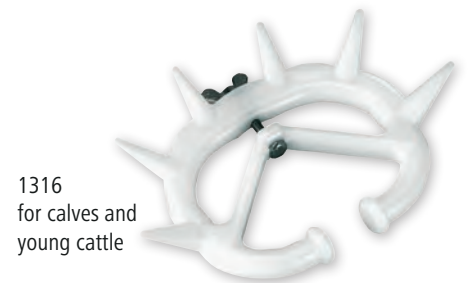
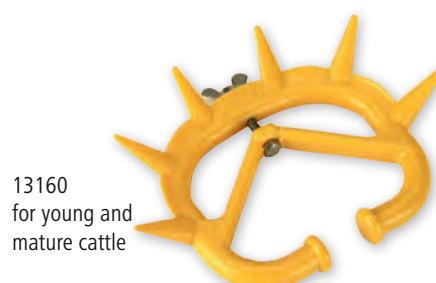
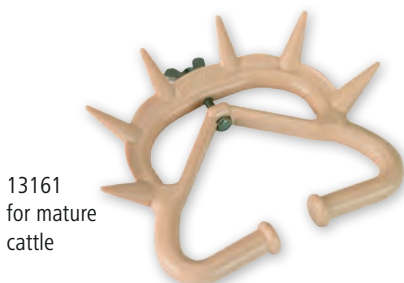

Ref. no.	Material	Colour	Suitable for	MOQ	Pieces / unit		€
1316	Plastic	white	Calves, Young cattle	6 pieces	6 / pack	1/6/210	
1316/2	Plastic	white	Calves, Young cattle	1 blister pack 2 / blister pack		1/105	
13160	Plastic	yellow	Young and mature cattle	6 pieces	6 / pack	1/6/210	
13160/2	Plastic	yellow	Young and mature cattle	1 blister pack 2 / blister pack		1/105	
13161	Plastic	beige	Livestock	6 pieces	6 / pack	1/6/210	
13161/2	Plastic	beige	Livestock	1 blister pack 2 / blister pack		1/105	

Cattle Weaner SuckStop Müller

The new and innovative Cattle Weaner SuckStop Müller will win you over with its extremely easy handling, its realised learning effect with the animal as well as the improvement of the animal's well-being.

Especially easy handling

The cattle weaner is really easy to use and can also be removed. The ring has a certain amount of elasticity which enables it to be applied without any aid. The cattle weaner is hooked onto the side of the nose and inserted into the other side by stretching the ring. The extensions here point upward.

Long-term learning effect

Regular weaning rings have spines that point outwards, which can irritate other animals and lead to a defence reaction. The animal with a strong suckling need will not learn from this situation. However, it's a different story with the new and innovative Cattle Weaner SuckStop Müller. It corrects the suckling animal. The rounded extensions turned inward press into the nose of the animal when suckling from another animal. This impulse disrupts the act and inhibits misbehaviour. This ensures a long-term learning effect, even after just a few weeks.

Improving animals' well-being

The innovative cattle weaner can be attached and secured without any aid. The ring cannot be attached too closely and injure the nasal septum.

Animals with newly attached rings start retaking food and water after a brief time because they feel no pain. Even nipple and tongue drinkers are used by the animals without problem with the Cattle Weaner SuckStop Müller. Calves can still drink from the feeding bucket. Thus there are no output losses in the herd.



13140



13141



13142



Ref. no.	Material	Colour	Suitable for	MOQ	Pieces / unit		€
13140	Plastic	transparent	Calves, Young cattle	6 pieces	6 / pack	1/6/210	
13140/2	Plastic	transparent	Calves, Young cattle	1 blister pack	2 / blister pack	1/105	
13141	Plastic	yellow	Young cattle, Livestock	6 pieces	6 / pack	1/6/210	
13141/2	Plastic	yellow	Young cattle, Livestock	1 blister pack	2 / blister pack	1/105	
13142	Plastic	white	Livestock	6 pieces	6 / pack	1/6/210	
13142/2	Plastic	white	Livestock	1 blister pack	2 / blister pack	1/105	

Cow Immobiliser FlexCow

This cow immobiliser developed together with farmers adjust itself automatically and continuously to nearly all cattle sizes thanks to the spring mechanism, thus applying constant light pressure on the flank. It prevents a setting that is too loose or too tight, preventing the animal from either escaping or putting too much pressure on it. The cow immobiliser increases the animal's comfort level as well as the work safety at the milking station.

- Patent pending • robust design • material: Stainless steel



Fast and safe insertion and removal:

1. The cow immobiliser can be set with the lock to the widest position, so that even milkers standing lower down can apply it to the cow quickly and easily.
2. When the lock is released with the cable pull, the cow immobiliser automatically adjusts to the size of the cow.
3. To remove the cow immobiliser, pull the bracket up again all the way to the lock, then remove it from the flank and back.

Ref. no.			€
110	1/10	150	

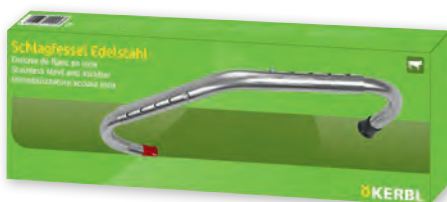

Cow Immobiliser

- when positioned correctly, this restraint prevents animals from thrashing around
- adjustable for different animal sizes
- the 45° offset of the hole series and the ø 9 mm thick locking bolts ensure ergonomic length adjustment and prevent inadvertent opening
- marking of the long side (= bottom) with the black cap

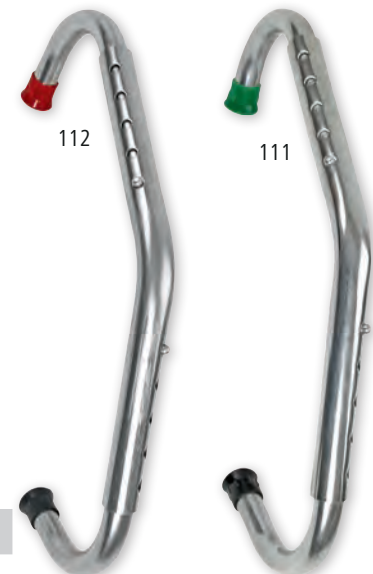
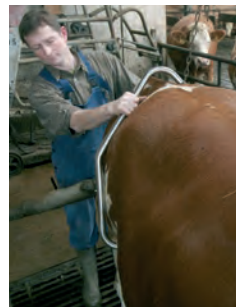

112 in single box



Ref. no.	Description	packaged			€
111	Galvanised Metal	unpackaged	1/10	240	
112	stainless steel	in individual box	1/10	160	

Spare Parts for Cow Immobiliser



Ref. no.	Description	Material	can be used for	MOQ	Pieces / unit		€
115	Individual Replacement Cap	Plastic	all models	10 pieces	10 / pack	1/10/1.000	
1147	Individual Replacement Spring (9 mm pin)	stainless steel	111, 112	10 pieces	10 / pack	1/10/1.000	
1148	Replacement Parts Kit with Spring and Cap		111, 112	1 blister pack	2 / blister pack	1	
1149	Replacement Spring Set		111, 112	1 blister pack	4 / blister pack	1	
116	Individual Replacement Spring (7 mm pin)	metal galvanised	Previous models 114, 1143	10 pieces	10 / pack	1/10/1.000	
1142	Replacement Parts Kit with Spring and Cap		Previous models 114, 1143	1 blister pack	2 / blister pack	1	
1144	Replacement Spring Set		Previous models 114, 1143	1 blister pack	4 / blister pack	1	

Kick Stop Amerika for cows

• prevents kicking, even on particularly stubborn animals • indispensable during examinations, medical treatments and artificial insemination



IMPORTANT: Not for lifting!

Ref. no.	Colour			€
113	blue	1	50	



Supporting Breeding Equipment

Ruminal magnets – for effective prevention of disease from foreign bodies.

Foreign bodies hidden in feed, such as nails, wires and metal splinters, represent a major risk to cattle because they are non-selective when eating: they get into the reticulum where they can bore through the stomach wall due to the reticulum contractions required for mixing and further transport of the food. This usually results in an infection of the abdominal cavity followed by an inflammatory response. The organs surrounding the reticulum can also be traumatised by this.

The early administration of a magnet to a cow suspected of having a foreign body can lead to recovery of the animal within two to three days. If the animal is not treated, the foreign body can migrate and cause peritonitis, which can lead to a total loss of the animal. Even the preventative administration of a magnet has proven successful.

Ruminal Magnet fortissimo

Made in Germany



- Neodymium magnets with very high attraction
- The arrangement of the magnets on the outer surfaces of the plastic jacket increases efficiency in comparison with internal magnets
- large interior space for incorporating foreign bodies
- foreign bodies adhering to the outer surfaces are moved to the inside through the rotation of the ruminal magnet in the stomach
- patented



A special design that is highly effective with a large interior for absorbing foreign bodies.



Ref. no.	Colour	MOQ	Pieces / unit		€
21160	beige	10 pieces	10 / pack	1/10/180	

Ruminal Magnet forte

- therapy and prophylaxis of hardware disease in cattle (traumatic indigestion)
- active ferrite magnetic system with high pulling power and adhesive strength for best therapeutic results
- powerful magnet extracts and collects hardware containing iron that has pierced the reticular wall shortly before



Ref. no.	Colour	Length	Width	Height	MOQ	Pieces / unit		€
21150	yellow	100 mm	35 mm	35 mm	10 pieces	10 / pack	1/10/200	

Ruminal Magnet

- For effective prophylaxis of disease from foreign bodies
- the ruminal magnet in the plastic housing should be given to all healthy cattle in good time as a preventative measure. Its magnetic force is sufficient to collect ferrous debris and to store them in the cage space.

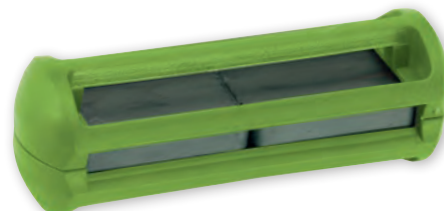

Ref. no.	Colour	Length	Width	Height	MOQ	Pieces / unit		€
2115	green	100 mm	35 mm	35 mm	10 pieces	10 / pack	1/10/200	
2115/2	green	100 mm	35 mm	35 mm	1 blister pack	2 / blister pack	1	

NEW

Introducer

for bolus and ruminal magnet

- for single-handed operation
- rounded edges
- Introducer sleeve: internal diameter 36 mm, length 11 cm, with retaining springs
- suitable for Calzogol bolus (item no. 15980), Ket-o-Vital bolus (item no. 15982), Fertigol bolus (item no. 15983), Vitagol bolus (item no. 15981) Phosphogol bolus (item no. 15987) and cage magnets



Ref. no.	Colour	Material	Length		€
2129	green	stainless steel	53 cm	1/30	
2139	green	stainless steel	70 cm	1/30	

Cattle halter in top quality

Halter



- extraordinary quality for the toughest demands • made from skin-friendly material • with adjustable head and nose band • leather-reinforced • with oval link and D-ring • with crenellated pattern • with simple round buckle

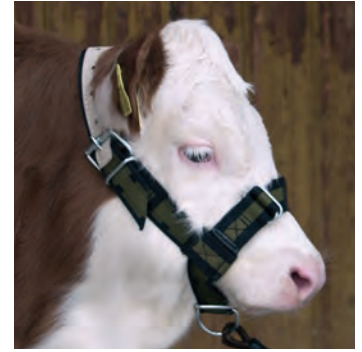

12501



12515

Ref. no.	Colour	Suitable for			€
12515	olive green / black	Calves	1/10	500	
12501	olive green / black	Cattle, Young bulls	1/10	750	

Made in Germany



Cow Halter with curb chain

- extraordinary quality for the toughest demands • made from skin-friendly material • with adjustable headband and curb chain that can be tightened for controlled guiding of the animal • leather-reinforced • with sturdy fittings • with crenellated pattern • with simple round buckle

Ref. no.	Colour			€
125010	olive green / black	1/10	500	

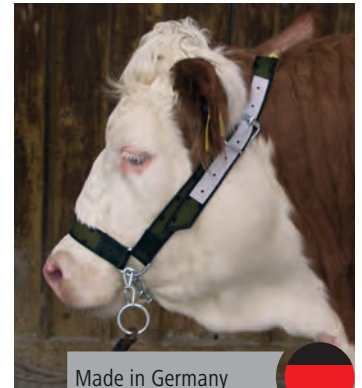

Made in Germany



Bull Halter

- made from heavy, very resistant leather • double layer • stable fittings • with simple round buckle • Material: Leather

Ref. no.	Colour			€
12510	light green	1/20	80	



Bridle

- doubly adjustable • with simple round buckle

Ref. no.	Colour		€
12613	red	1/50	
12614	blue	1/50	



Made in Germany



The right answer for cattle of all kinds

- Solid, high-quality galvanised chain and fitting parts
- Increased tensile and tear resistance thanks to a special braiding method
- Use of extra-thick, skin-friendly strap material for maximum resilience
- Additional leather reinforcement for securely fastening the pin buckle

Made in Germany

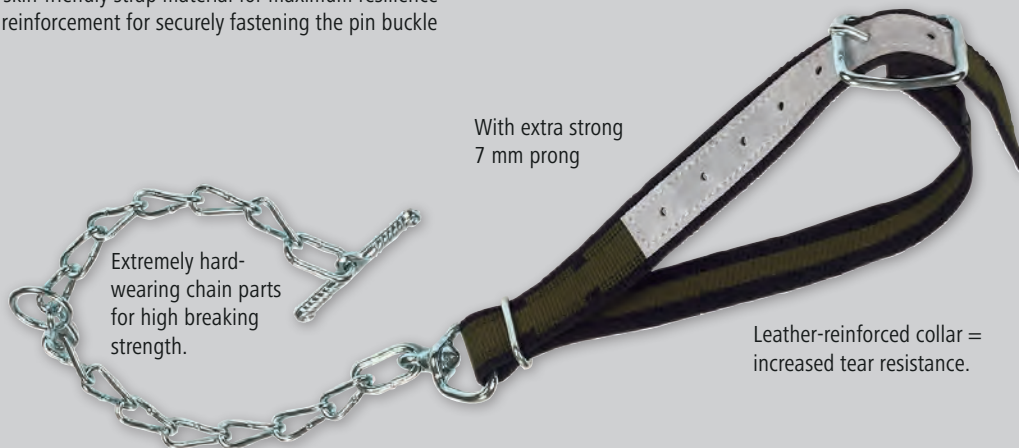

Extremely hard-wearing chain parts for high breaking strength.

With extra strong 7 mm prong

Leather-reinforced collar = increased tear resistance.

Calf tethering Top Quality

- all chain components galvanic zinc-plated



Ref. no.	Collar	Tether Part	Link thickness		€
12461	85 x 4 cm	Chain Component Single with swivel and toggle	5 mm	1/10/50	

Ref. no.	Description	Colour	Length	Width		€
12460	Collar with oval link and D-ring	black / olive green	85 cm	4 cm	1/10/100	

Young cattle tethering Top Quality

- all chain components galvanic zinc-plated

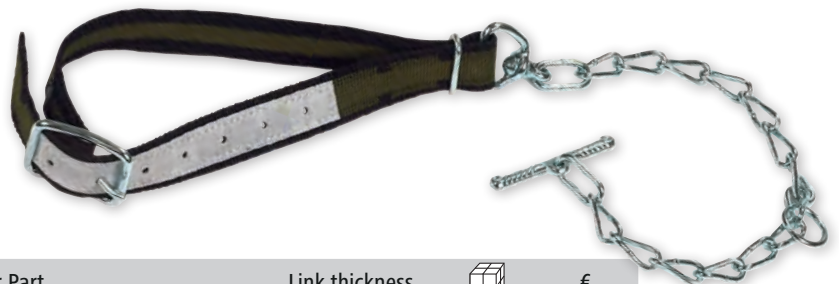

Ref. no.	Collar	Tether Part	Link thickness		€
125303	100 x 4 cm	Chain Component Single with swivel and toggle	5 mm	1/10/50	

Ref. no.	Description	Colour	Length	Width		€
12508	Collar with oval link and D-ring	black / olive green	100 cm	4 cm	1/10	

Chain Component for tethering calves and young animals

- all chain components galvanic zinc-plated



Ref. no.	Tether Part	Length	Link thickness		€
12462	Chain Component Single with swivel and toggle	60 cm	5 mm	1/10/50	
1238	Chain Component Single with carabiner and toggle	63 cm	5 mm	1/10/50	

Cattle Tethering Top Quality with collar

• all chain components galvanic zinc-plated

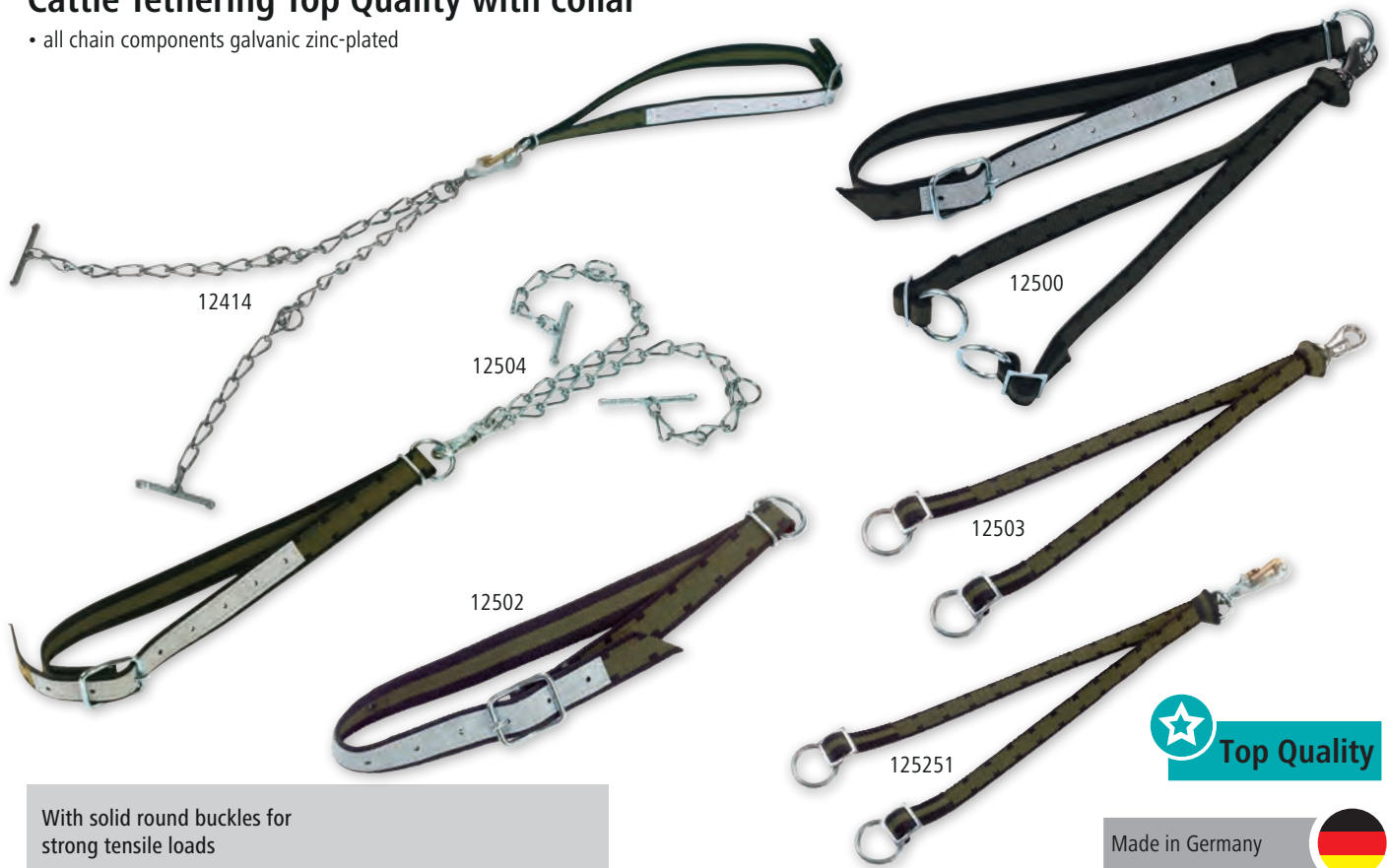

With solid round buckles for strong tensile loads

Top Quality

Made in Germany



Ref. no.	Collar	Tether Part	Link thickness		€
12504	130 x 4 cm	Chain Component Double with carabiner and toggle	6 mm	1/10	
12414	130 x 4 cm	Chain Component Double with small safety lock and toggle	6 mm	1/10	
12500	130 x 4 cm	Floor Belt Double with carabiner and rings		1/10	

Ref. no.	Description	Colour	Length	Width		€
12502	Collar with oval link and D-ring	black / olive green	130 cm	4 cm	1/10	
12503	Floor Belt double with carabiner hook		60 cm		1/10/60	
125251	Floor Belt double with small safety lock		60 cm		1/10/50	

Chain Component for tethering cattle

• all chain components galvanic zinc-plated



Ref. no.	Tether Part	Length	Link thickness		€
12509	Chain Component Single with carabiner and toggle	66 cm	6 mm	1/10/40	
12505	Chain Component Double with carabiner and toggle	70 cm	6 mm	1/10/20	
12528	Chain Component Double with small safety lock and toggle	82 cm	6 mm	1/10	

Young bull tethering Top Quality

- all chain components galvanic zinc-plated



Made in Germany



With double roller buckle for heavy tensile loads



Ref. no.	Collar	Tether Part	Link thickness		€
12520	150 x 5 cm	Chain Component Double with swivel, D-ring and toggle	7 mm	1/5	

Ref. no.	Description	Colour	Length	Width		€
12521	Collar with oval link and D-ring	black / olive green	150 cm	5 cm	1/10	

Cattle Connector Top Quality

- all chain components galvanic zinc-plated



With double roller buckle for heavy tensile loads
Extra-reinforced prongs for optimum safety

Made in Germany



Ref. no.	Collar	Tether Part	Link thickness		€
1228	170 x 7 cm	Chain Component Double with swivel, D-ring and toggle	7 mm	1/5	
12411	170 x 7 cm	Chain Component Double with large safety lock and toggle	7 mm	1/5	

Ref. no.	Description	Colour	Length	Width		€
1230	Collar with oval link and D-ring	black / olive green	170 cm	7 cm	1/5/30	

Hoof Cutting Disc ProTrim

Our new Cutting Disc ProTrim offers you an innovative tool for professional hoof care. This cutting disc specially developed for hoof care will win you over with its excellent cutting ability, its clean cut surfaces and its excellent handling properties.

- excellent handling of the sole of the hoof and the interdigital space
- the very clean cutting are does not require any additional treatment
- its light weight and systematic arrangement of the blade ensure even lower operating noise
- its closed edge limits shavings being thrown out and reduces the risk of injury to the animal and the user
- incl. 6 replaceable hard metal reversible blades
- 4-sided, usable reversible blades ensure an optimal price-performance ratio
- easy handling due to quick release screw connection, among other things
- Material: Aluminium

Ref. no.	Ø	Cutting height		€
16366	114 mm	2 mm	1/30	

Ref. no.	Description	MOQ	Pieces / unit		€
16367	Blade Set	1 pack	10 / pack	1/10	



Made in the EU



Hoof Cutting Disc

- the base body of the blade is made from aluminium, providing for easy handling
- low weight ensures even greater smoothness
- the diagonal angle of the cutting elements means the horn is removed faster and more gently
- the very clean cutting are does not require any additional treatment
- The cutting elements can be used on both sides (blades can be turned round)
- can be replaced individually
- easy handling due to quick release screw connection, among other things
- Cutting height: 1.2 mm (1.8 mm with guard)
- Material: Aluminium



Ref. no.	Description	Ø	MOQ	Pieces / unit		€
16318	6 Cut	120 mm	1 blister pack	1 / blister pack	1/50	
16316	3 Cut	120 mm	1 blister pack	1 / blister pack	1/50	

Ref. no.	Description		€
16320	Blade Set Profi (3 blades and screws)	1/25	

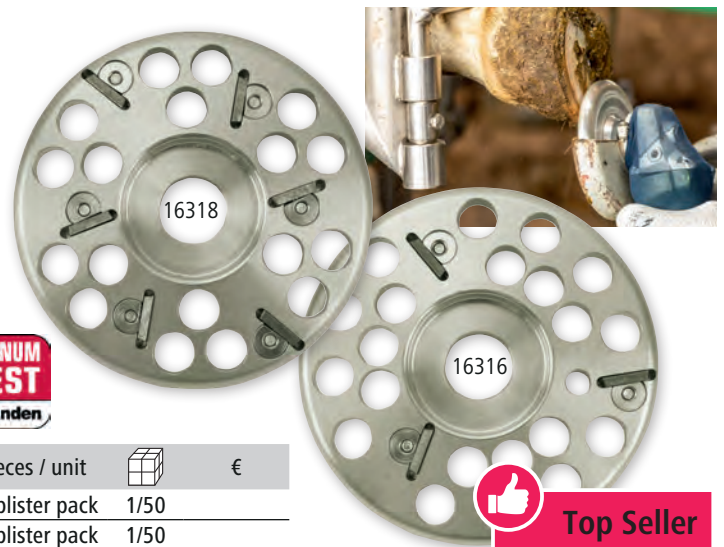

Top Seller

Made in Germany



Hoof Cutting Disc P6

the optimised geometry and arrangement of the blade set enable excellent handling of the soles of the hoof and the interdigital space the P6 thus has the significant advantage that no other hoof care tool is necessary

- complete base Disc: quieter operating noise and reduced vibrations increased the Disc's service life
- inclined contact surface: perfect handling and high ergonomic efficiency
- Carbide blade made from the finest grain alloy with improved durability allows the processing of up to 600 pairs of hooves (prerequisite: no stone inclusions!)
- cutting geometry: optimised position of the blade for the cleanest cut and 40 % faster cutting than with regular discs
- Material: metal

Developed with professional hoof trimmers!

Ref. no.	Colour	Ø	Cutting height		€
16358	red	105 mm	1,5 mm	1/50	
16360	orange	125 mm	1,5 mm	1/50	



Made in Germany



Hoof Cutting Disc SuperProfi

Developed with hoof trimmers for hoof trimmers and experienced farmers!

Directly soldered carbide blades on a compact 90 mm metal disc with optimised radii provide excellent abrasion, very good handling characteristics and low vibration! The cut material is removed gently and quickly by the disc using specially shaped recesses without accumulation.

- the radial extension of the carbide tips allows experienced users to work on defective points in the claw wall, permitting hollow grooves to be made
- conical design of the body back, permitting good entry into the gap between claws
- carbide blade made from the finest grain alloy with improved durability allows the processing of up to 1,500 pairs of hooves (prerequisite: no stone inclusions!)



Made in Germany



Ref. no.	Colour	Ø	Cutting height		€
16309	blue	90 mm	3 mm	1/50	

Hoof Abrasive Disc Standard

- hoof plate made of twisted steel dish with carbide assembly
- excellent value for money
- incl. instructions

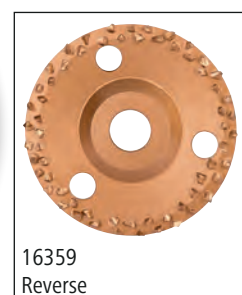



Top Seller

Ref. no.	Ø	Grain on the front	Grain on the back	Design	MOQ	Pieces / unit		€
16348	115 mm	30		one-sided	1 blister pack	1 / blister pack	1/50	
16349	125 mm	30		one-sided	1 blister pack	1 / blister pack	1/50	
16359	115 mm	30	30	both sides	1 blister pack	1 / blister pack	1/50	

Hoof Abrasive Disc wide

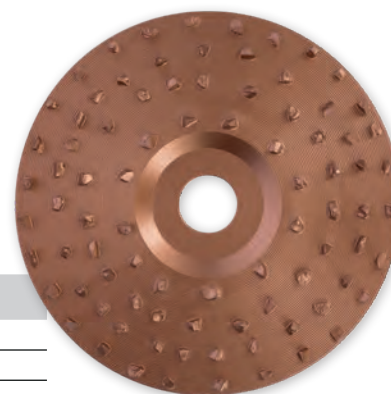
- hoof plate made of twisted steel dish with carbide assembly
- excellent value for money
- incl. instructions



Ref. no.	Ø	Placement	Grain on the front	Design		€
16377	115 mm	wide	40	one-sided	1/50	
16353	125 mm	wide	40	one-sided	1/50	
16354	150 mm	wide	40	one-sided	1/50	

Hoof Abrasive Disc

- for one-handed angle grinders
- wavy surface structure
- for grinding and cleaning hooves and claws
- Long service life

Beim Arbeiten unbedingt einen Stützteller verwenden!

Ref. no.	Ø	MOQ	Pieces / unit		€
1627	115 mm	5 pieces	5 / pack	1/5/200	
1627/2	115 mm	1 blister pack	2 / blister pack	1	
1631	127 mm	5 pieces	5 / pack	1/5/200	
1631/2	127 mm	1 blister pack	2 / blister pack	1	
1633	178 mm	5 pieces	5 / pack	1/5/100	



Hoof and claw knife SuperProfi

The knife for the professional hoof trimmer and farrier as well as for anyone who needs a perfect tool for hoof and claw care!

- high alloy special steel for long life and grindability
- 0° scalpel cut for exceptional sharpness and cutting performance
- ergonomic handle made from heat-treated beech wood



as sharp as a scalpel

Ref. no.	Length	Cutting side	Blade length	Blade width	Cutting edge length		€
16814	20 cm	single-edge right	70 mm	10 mm	57 mm	1/10/200	
16815	20 cm	single-edge left	70 mm	10 mm	57 mm	1/10/200	



Hoof and claw knife Profi

- made from high-quality special steel developed for cutting tools
- improved cutting performance
- optimised grinding properties
- revised blade radius for more precise working
- ergonomically shaped noble wood handle for fatigue-free working



Ref. no.	Length	Cutting side	Blade length	Blade width	Cutting edge length	MOQ	Pieces / unit		€
16801	20 cm	single-edge right	82 mm	11 mm	71 mm			1/10/200	
16801/1	20 cm	single-edge right	82 mm	11 mm	71 mm	1 blister pack	1 / blister pack	1	
16802	20 cm	single-edge right	80 mm	17 mm	70 mm			1/10/200	
16803	20 cm	single-edge left	82 mm	11 mm	71 mm			1/10/200	
16803/1	20 cm	single-edge left	82 mm	11 mm	71 mm	1 blister pack	1 / blister pack	1	
16804	20 cm	single-edge left	80 mm	17 mm	70 mm			1/10/200	
16805	20 cm	double-edged	80 mm	17 mm	70 mm			1/10/200	
16805/1	20 cm	double-edged	80 mm	17 mm	70 mm	1 blister pack	1 / blister pack	1	

Hoof and claw knife

- inexpensive tool with excellent cutting and sanding properties
- blade made from rust-free steel
- with moulded wooden handle



Ref. no.	Length	Cutting side	Blade length	Blade width	Cutting edge length		€
16163	21 cm	single-edge right	83 mm	11 mm	69 mm	1/10/200	
16164	21 cm	single-edge left	83 mm	11 mm	69 mm	1/10/200	
16160	21 cm	double-edged	85 mm	12 mm	48 mm / 68 mm	1/10/200	

DICK Diamond Sharpening Rod

• excellent professional tool • Working length and diamond coating are ideal for sharpening the cutting edges and curves (channels) of all hoof knives • with Ergonom Sympa handle with hanging hole • High service life • also for other cutting tools

Made in Germany



Ref. no.	Length		€
16169	31 cm	1/5	



Sharpening Stone

• for hoof knives • flat oval shape

Ref. no.		€
1612	1/200	



Hoof and Claw Cutter

• with double action compound joint • with set screw and replaceable blades

Ref. no.	Colour	Length		€
163	dark green	41 cm	1/10	

Ref. no.	Description		€
164	Blades in pairs	1/100	

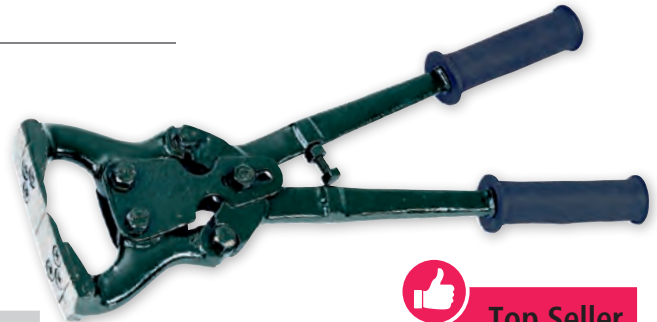

Top Seller

Hoof Side Cutter

• ideal for preliminary work on hard hoof mass • slightly curved

Ref. no.	Colour	Length		€
165	green	64 cm	1/5	



DICK Hoof Rasp

• flat, blunt shape with plastic handle • high power: one side with extra-sharp and deep rasp cut, one side with coarse file cut

Ref. no.	Cut length	Width	Height		€
16168	20 cm	4,5 cm	0,5 cm	1/5	
16165	30 cm	4,2 cm	0,5 cm	1/5	

Made in Germany



16168



16165

Hoof Rasp with handle

• Handle length: 12.5 cm

Ref. no.	Cut length		€
16161	35 cm	1/5/20	



Top Seller

Hoof Rasp

• straight design • with extra sharp and deep rasp cut

Ref. no.	Cut length	Width	Height		€
1616	35 cm	3,6 cm	0,75 cm	1/5/40	

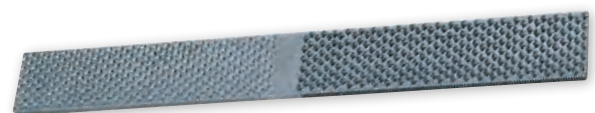

DICK Chopping Blade

- Hatchet-Shaped Chopping Blade • specially sharpened cutting edge
- high-quality, rust-free carbon steel • with "softgrip" PVC handle

Ref. no.	Length	Blade width		€
1657	36 cm	3,1 cm	1/10	



Made in Germany



Chopping Blade with handle

- whetted • Material: stainless steel

Ref. no.	Length	Blade width		€
1615	30 cm	3 cm	1/10/60	



DICK Shoeing Mallet

- robust design

Ref. no.	Material	Length		€
32670	Beechwood	30 cm	1/25	



Made in Germany



KNIPEX Hoof Pliers

- with rivet joint • can also be used as farrier's tongs • Cutting edge hardness approximately 56 HRC • Special tool steel, oil-hardened

Ref. no.	Length		€
1618	30 cm	1/6	



Hoof pliers

- robust design

Ref. no.	Length		€
16182	36 cm	1/5/25	



Hoof-Checking Pliers

- forged steel • with straight legs

Ref. no.	Length		€
1619	30 cm	1/6/30	



Shoeing Hammer

- forged design • with steel-reinforced wooden handle

Ref. no.	Length			€
1650	33 cm	1/12/48	240	



Hoof Nail Clinch

- for pulling hoof nails

Ref. no.	Length		€
1666	35 cm	1/6/36	



Hoof Shoe Tubbease™

Tubbease™ was developed in New Zealand with the aim to create a breathable treatment shoe for problem horse hooves (e.g. sole ulcers). The supplied hook and loop tapes mean Tubbease™ is easy to attach to the horse's leg.

- can escape upwards meaning no heat or humidity is trapped within the shoe
- the rubber-coated base reliably prevents moisture from entering and simultaneously ensures that the treatment fluid remains on the hoof
- the optimum climate within the shoe means the hoof retains its natural strength
- the thick EVA insole reduces pressure pain for the horse (e.g. with sole ulcers) and extends the life of Tubbease™
- various remedies to treat abscesses, thrush, hoof injuries, hoof outbreaks etc. can be used with Tubbease™
- tubbease™ design is protected (NZ 417646)
- Important: only use during stall rest
- EVA insert not included

Ref. no.	Colour	Size	Ø		€
3211765	purple	XS	7,5 cm	1/8/48	
3210559	pink	S	11 cm	1/8/48	
3210560	red	M	14 cm	1/8/48	
3210561	blue	L	15,5 cm	1/8/48	
3210562	orange	XL	16,5 cm	1/8/48	
3210596	yellow	XXL	17,5 cm	1/8/48	

Ref. no.	Description	Colour	Size		€
3211766	EVA Insert Tubbease™	purple	XS	1/2/80	
3211767	Hook and Loop Fastener in pairs	purple		1/40	
3210595	EVA Insert Tubbease™	pink	S	1/2/40	
3222300	Hook and Loop Fastener in pairs	pink		1/40	
3210564	EVA Insert Tubbease™	red	M	1/2/24	
3222301	Hook and Loop Fastener in pairs	red		1/40	
3210565	EVA Insert Tubbease™	blue	L	1/2/24	
3222302	Hook and Loop Fastener in pairs	blue		1/40	
3210566	EVA Insert Tubbease™	orange	XL	1/2/20	
3222303	Hook and Loop Fastener in pairs	orange		1/40	
3210597	EVA Insert Tubbease™	yellow	XXL	1/2/20	
3222304	Hook and Loop Fastener in pairs	yellow		1/40	



SHOOF Hoof Shoe

- made from sturdy, durable polyurethane
- this hoof shoe was developed as an aid for the worldwide problem of repairing damage (injuries) to cattle hooves
- ideal for high stress on hooves on hard surfaces such as concrete floors, hoof rot, twisted toes, damage caused by natural malformation, cuts to the sole due to sharp stones etc.
- reduces the penetration of dirt and bacteria
- prevents infectious diseases
- polyurethane

Ref. no.	Colour	Size	Design		€
16501	yellow	M	both sides	1/25/100	
16505	yellow	M	right	1/10/100	
16509	yellow	M	left	1/25/100	
16502	blue	L	both sides	1/80	
16506	blue	L	right	1/20/80	
16510	blue	L	left	1/20/80	

Ref. no.	Description		€
16520	Spare Set for cows	1/20/400	



Treatment Shoe for hooves and claws

Durable and robust treatment shoe made of canvas with two bands. Ideal for treating horse or cattle hooves with ointments or solutions.

- strong plastic sheet on the inside to allow the treatment solution to work effectively
- Standard size (15 x 30 cm)

Ref. no.	Length	Width		€
16143	30 cm	15 cm	1/50	



Hoof Bandage Vetlastic

Specially for claw care and for self-adhesive bandages developed for veterinary use! Vetlastic is characterised by a thick fabric with an enhanced latex coating, thus providing extra adhesive power! Despite the compact material thickness, Vetlastic can be easily torn laterally!

- medium-elastic, self-adhesive bandage • very hard to tear lengthwise, but easy to tear laterally • does not stick to hair or to itself • modern latex-reinforced high-tech synthetic material • easy to put on, even on the most difficult places

Ref. no.	Colour	Length	Width		€
1663	light green	450 cm	7,5 cm	1/24/144	
1664	light green	450 cm	10 cm	1/18/108	
1667	blue	450 cm	7,5 cm	1/24/144	
1668	blue	450 cm	10 cm	1/18/108	
1672	black	450 cm	7,5 cm	1/24/144	
1673	black	450 cm	10 cm	1/18/108	
1675	red	450 cm	7,5 cm	1/24/144	
1676	red	450 cm	10 cm	1/18/108	



Especially recommend for winter due to enhanced latex coating!
Recommended by hoof care professionals!

This product was specially developed to treat large animals and is only for use in veterinary medicine/hoof and claw care.

Self-adhesive Bandage EquiLastic

- highly-elastic, self-adhesive bandage • very hard to tear lengthwise, but easy to tear laterally • does not stick to hair or to itself • easy to put on, even on the most difficult places • Year-round bandage for support and other dressings.

Ref. no.	Colour	Length	Width		€
1685	red	450 cm	5 cm	1/12/288	
1687	red	450 cm	7,5 cm	1/12/192	
1694	red	450 cm	10 cm	1/12/144	
1683	blue	450 cm	5 cm	1/12/288	
1688	blue	450 cm	7,5 cm	1/12/192	
1695	blue	450 cm	10 cm	1/12/144	
1686	black	450 cm	5 cm	1/12/288	
1689	black	450 cm	7,5 cm	1/12/192	
1697	black	450 cm	10 cm	1/12/144	
16551	violet	450 cm	5 cm	1/12/288	
16553	violet	450 cm	7,5 cm	1/12/192	
16555	violet	450 cm	10 cm	1/12/144	
16550	green	450 cm	5 cm	1/12/288	
16552	green	450 cm	7,5 cm	1/12/192	
16554	green	450 cm	10 cm	1/12/144	
1684	white	450 cm	5 cm	1/12/288	
1690	white	450 cm	7,5 cm	1/12/192	
1692	white	450 cm	10 cm	1/12/144	



The optimal summer bandage for claw care!

This product was specially developed to treat large animals and is only for use in veterinary medicine/hoof and claw care.

Bandage Knife

Developed with professional hoof trimmers

- for the easy and safe removal of claw bandages • curved shape for injury-free working • very sharp and replaceable blade • also suitable for removing shackle bands, neck marking tapes etc. or for opening straw bales

Ref. no.	Length		€
16830	80 cm	1/10	

Ref. no.	Description	MOQ	Pieces / unit		€
16831	Spare Blade for bandage knife	1 pack	10 / pack	1/10	



New product

NEW

Technovit® 6091



The special properties of fast-curing plastic Technovit 6091 make it an indispensable, universal resin used in veterinary medicine for claw care and treatment. In some areas of treatment, Technovit 6091 aids the vet's therapeutic measures and shortens otherwise quite long healing periods. In claw and hoof treatment, Technovit 6091 is especially suitable for the following: for immobilizing claws in the event of inflammatory diseases, fixing claw tips, concealing hoof defects, horn cracks, shaping hooves and orthopaedic hoof treatment, especially in foals (e.g. clubfoot, prosthesis).

Technovit® 6091

The indispensable universal tool for claw treatment

- the classic claw treatment system! • the market-leading system for claw immobilisation through wood blocks used and approved for more than 15 years!

16220: Powder has already been packaged in 12 bags of 70 g each!

Technovit® 6091 with catalyst

- low outside temperatures generally lengthen the curing time of glue in claw treatment systems with wood blocks or shoes • The unique advantage of the Technovit catalyst is its ability to shorten this polymerisation time by up to 50 % • A problem-solver for colder months

Temperature	Recommended Mixture ratio Catalyst: Liquid	Curing time with catalyst	Curing time without catalyst
+ 5 °C	1 : 7	Approx. 13 min.	Approx. 24 min.
+ 10 °C	1 : 10	Approx. 9 min.	Approx. 15 min.
+ 20 °C		Approx. 5 min.	Approx. 8 min.

Ref. no.	Description	Applications		€
1621	without accelerator	2-pce mix	1/100	
1622	without accelerator	10-pce mix	1/6	
16220	without accelerator	12-pce mix	1/6	
16121	incl. accelerator	2-pce mix	1/100	
16122	incl. accelerator	10-pce mix	1/6	

Ref. no.	Description	Contents		€
16232	Accelerator Technovit® 6091		1/120	
1623	Powder Technovit® 6091	1000 g	1/70	
1624	Liquid Technovit® 6091	500 ml	1/144	

Please note the use and safety instructions.

Technobase 8000

Universal plastic for veterinary medicine

- rapid processing: can be modelled immediately after mixing • Technobase 8000 cures fully in less than 4 minutes at 20 °C product temperature • highly adhesive so you can be sure that the diseased claw will be perfectly spared until the wood block has worn off • models without becoming sticky: the dough remains flexible and can be shaped and processed until polymerisation • low temperature at the end of polymerisation, therefore extra-cutaneous splinting can be performed safely and without affecting the tissue

Ref. no.	Applications		€
16251	14-pce mix	1/6	
16259	4-pce mix	1	

recommended by hoof care professionals!



Ref. no.	Description	Contents		€
16257	Liquid for Technobase 8000	500 ml	1	
16258	Powder for Technobase 8000	1000 g	1/70	
16231	Wooden Spatula for Technobase 8000		1/100	



Please note the use and safety instructions.

Hoof Block HoloBlock

- made from wood fibres • biodegradable material • patented shape • nubs on the surface ensure optimal spacing between the claw and the block • glue forms a stable structure via integrated holes on the surface and honeycomb hollow spaces • very strong adhesion and no unnecessary use of glue • hollow spaces enable easy and effective heating of the glue • ideal for treatments with a quick healing process

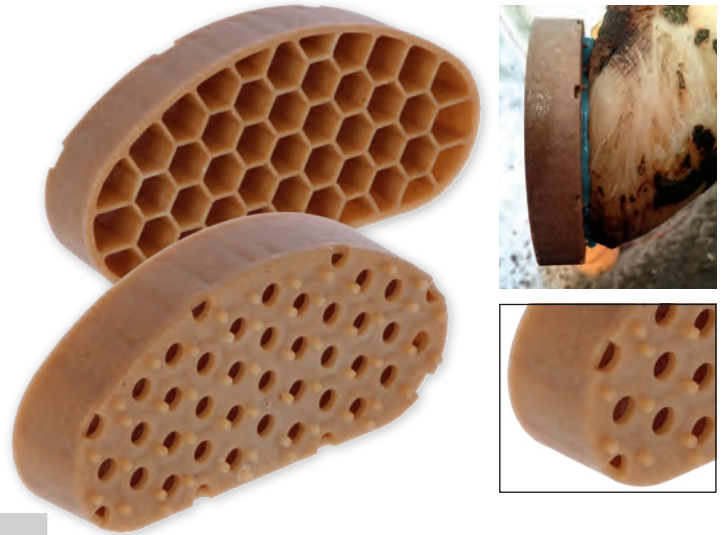

Ref. no.	Length	MOQ	Pieces / unit		€
16136	114 mm			1/250	
16137	114 mm	1 pack	10 / pack	1/30	

Wooden Block Wedge shape

- recommended for low heel height to increase the ball area
- also suitable for „normal“ hooves on highly abrasion-resistant floors (such as concrete)



recommended by hoof care professionals!

Ref. no.	Description	Length		€
16132	Standard	112 mm	1/50	
16133	XL	130 mm	1/50	

Wooden Block flat design

- extra flat design (50% lower in height than a standard block) for uses requiring early loading of the injured hoof • prevention of any tendon problems that may occur if the block is worn for an extended period • mainly used for low-wear rubber flooring instead of standard blocks • developed in line with the latest hoof care theory with hoof care specialists



Ref. no.	Length		€
16134	112 mm	1/50	
16135	130 mm	1/80	

Wooden Block Standard



Ref. no.	Description	Length	MOQ	Pieces / unit		€
16105	XL	130 mm			1/50	
16105/10	XL	130 mm	1 pack	10 / pack	1/50	
16104	Standard	112 mm			1/100	
16104/10	Standard	112 mm	1 pack	10 / pack	1/100	
16104/2	Standard	112 mm	1 pack	2 / pack	1	

Technovit®-2-Bond

The fast, 2-part PU adhesive for hoof treatment!

- The benefits at a glance: • dries within 30 seconds • can be used at a 45° and a 90° angle • the hoof can bear full weight again after approx. 3 minutes (if stored correctly over 15° C) • bonds powerfully and permanently to wood and rubber blocks
- easy to use - no mixing, no waste



16292



Set includes:	16239	16240
1 x 160 ml cartridge with 2-part adhesive	x	x
10 x mixing tips	x	x
10 x wooden blocks XL	x	x
1 x dispensing gun	x	-

TV

Please note the use and safety instructions.

Ref. no.	Description	Applications		€
16239	Starter Set with Dispensing Gun	10-pce mix	1	
16240	Set without dosing gun	10-pce mix	1	

Ref. no.	Description	Contents	MOQ	Pieces / unit		€
16241	Cartridge Technovit®-2-Bond	160 ml / Cartridge			1/10	
16292	Dispensing gun for Technovit-2-Bond for 160 ml cartridge				1/10	
16243	Mixer Cannula for Technovit-2-Bond		1 pack	10 / pack	1/10/240	

NEW

Block Bond Eco®

2-component latest generation claw adhesive

The two-component polyurethane adhesive Block Bond Eco® has been specially developed for hoof care and the safe and rapid gluing of wooden blocks with bovine hooves. Block Bond Eco® guarantees that the block adheres firmly to the hoof, giving the hoof enough time to completely heal. The main advantage is the high strength and the speed of application. The patented Block Bond Eco® formula has no carcinogenic ingredients at all. This makes Bond Eco® one of the most user and cow-friendly hoof adhesives on the market. The increased efficiency in hoof care, easy and fast application and the optimal cow healing support is of particular note in this new adhesive technology.

New product

NEW

Experience the advantages of the latest generation of hoof glue

Especially fast

- Makes your work really efficient.
- Processing time: 10 s / fixture time: 20 s / time to full load: 1:30 - 3:30 min. depending on outside temperature.

Especially strong

- Exceptionally strong, permanent bonds.
- Highly reliable bond while healing takes place.

Especially safe

- No carcinogenic hazardous substances in the formula.
- High health protection for users and cows.

Fresh, premium quality

- German manufacturer. The latest scientific research.
- High quality. Fresh product. Highly durable.

Summer & winter

- Suitable for all seasons, from 0 °C to +30 °C.
- No crystallisation at subzero temperatures.



16273
up to 10 °C

16297



16299

Please note the use and safety instructions.

Ref. no.	Description	Contents		€
16297	Cartridge	200 ml	1/36	

Ref. no.	Description	MOQ	Pieces / unit		€
16273	Mixer Cannula	1 pack	12 / pack	1/10	
16299	Dispensing gun for 200 ml cartridge			1/5	

Thermal Container HeatBox

The solution to problems using two-component adhesives for hoof care in winter! HeatBox is the perfect way to keep two cartridges at the correct temperature during use in stables, thanks to the temperature-critical property of its chemistry.

- one heat chamber each for cartridges in the pistol and for spare cartridges
- fits all common 200 ml cartridges such as Technobase 2CB
- constant temperature in the chamber of 20 °C thanks to integrated thermostat
- Control light to check the power supply
- incl. metal bracket for attaching to the hoof stand or bar/tube
- with vehicle plug and power pack for connection to a 230 V power supply
- suitable dispensing guns: item no. 16299, 16284, 16242, 16292



New product

NEW



Technical data	
Voltage	12 V DC
Mains frequency	50 - 60 Hz
Connecting Cable	
Protection class	IPX4



Ref. no.	Colour	Heating output	Length	Width	Height		€
16279	grey	30 W	17 cm	12 cm	17,5 cm	1/12	

Hoof Care Walkease

For rapid intervention in case of hoof problems

The novel combination of EVA hoof block and secondary adhesive makes hoof care very easy

- extremely quick - the hoof can take weight again after 10 seconds
- extremely economical - small amounts of glue are enough for a secure grip
- extremely comfortable - no mixing of liquids and powders
- extremely easy - work the cleaned hoof with a special hoof rasp - glue to block - press for about 10 seconds, and you're done!

The hoof block is available in 4 sizes; special material absorbs the hoof impact and enables uniform wear.

The special angled 'Wedgy' block (16488) is modelled on the latest findings on hoof rest positions to protect tendons and ligaments and to allow correct wear, especially on rough ground.

Included in delivery: 10 x hoof blocks, 1 x adhesive (10 x 2 ml), 1 x rasp, 1 x disposable gloves, 1 x instruction manual and DVD

Important: The cleaned hoof must be properly prepared with the Shoof hoof rasp to produce perfect adhesion! The hoof and hoof block must be clean and dry!



Ref. no.	Colour	Size	Applications		€
16481	yellow	M	10-pce mix	1/12	
16482	blue	L	10-pce mix	1/12	
16489	mixed	S / M / L	10-pce mix	1/12	



Ref. no.	Description	Size	Contents	MOQ	Pieces / unit		€
16483	Hoof Block Walkease	S		1 pack	10 / pack	1/10	
16484	Hoof Block Walkease	M		1 pack	10 / pack	1/10	
16485	Hoof Block Walkease	L		1 pack	10 / pack	1/10	
16488	Hoof Block Walkease "Wedgy", angled large			1 pack	10 / pack	1/10	
16486	Adhesive Walkease		2 ml	1 pack	10 / pack	1/10/120	
16487	Rasp Walkease					1/50	

Kromberg Hoof Bandage

• for bandaging and application of protective bandages

Ref. no.	Colour	Length	Width	MOQ	Pieces / unit		€
1638	black	25 m	45 mm	5 pieces	5 / pack	1/5/60	



Top Seller

Made in Germany



Certoplast Hoof Bandage

• for bandaging and application of protective bandages • Type Certoplast/Vorwerk

Ref. no.	Length	Width	MOQ	Pieces / unit		€
16381	25 m	45 mm	5 pieces	5 / pack	1/5/60	

Made in Germany



Hoof Bandage ClawTape

• Textile Strip for Hoof Care • for bandaging and application of protective bandages
• with high-quality natural rubber adhesive • high adhesion • adhesive on both sides
• simple to use and easy to tear by hand

Ref. no.	Colour	Length	Width		€
16378	black	25 m	45 mm	1/5/60	

Available from: April 2020



New product

NEW

Tesa Hoof Bandage

• Woven Cotton Tape • air permeable and adhesive on one side (meaning no straw etc. sticks)

Ref. no.	Colour	Length	Width	Material thickness	MOQ	Pieces / unit		€
16382	black	50 m	50 mm	0,3 mm	3 pieces	3 / pack	1/3/18	



Hoof Bandage VetTape

• with strong rubber adhesive • adheres securely • tried and tested for hoof bandages • air permeable

Ref. no.	Colour	Length	Width		€
16388	white	50 m	50 mm	1/12	
16390	black	50 m	50 mm	1/12	

Recommended by veterinarians!



Hoof Bandage Silbertape

• watertight design (suitable for pens) • excellent tear resistance • very good adhesive properties • easy to use

Ref. no.	Colour	Length	Width		€
16385	silver	50 m	50 mm	1/24	



Adhesive Tape

• high-quality, PE-coated industrial adhesive tape coated with natural rubber glue • has an excellent initial bonding force - even at low temperatures • excellent bonding to different surfaces • excellent unrolling behaviour • Areas of application: • Hoof Care • repairs, water-proof packaging • Protection, Covering, Fixing • labelling, packaging, bundling • Tear resistance: 180 N/25 mm • Bonding force on steel: 15 N/25 mm

Ref. no.	Colour	Length	Width		€
291335	black	50 m	19 mm	1/60	
291336	black	50 m	50 mm	1/24	



Footbath Container SuperKombi

The Footbath SuperKombi can be connected both lengthways and sideways. Depending on the space available in the stable, this means you can create ideal situations for the cows. The consecutive baths ensure better hygiene: The first bath serves as a rinse to get rid of dirt and faecal residues from the hooves. The second bath, the hoof hardening bath, thus remains free of dirt for longer, the disinfection solution remains usable for longer. The newly developed base profile ensures optimal traction. The animals go through the hoof bath more calmly, which promotes longer contact, achieving a better result. The shape and height of the profile ensure that the cow's hoof is slightly spread, allowing the hoof bath to reach areas between claws where it will be most effective more easily.

- expandable length or width-ways • high impact polyethylene for abrasion and chemical resistance • suitable for use with all types of hoof bath solutions
- With gauge display • Material: polyethylene



Top Quality

Made in the EU



TV

Footbaths can be lined up one after another using the teeth provided

specially designed anchor points make it easy to line up additional containers



With gauge display



Base with special nub profile



16601



Ref. no.	Colour	Length	Width	Height	Capacity			€
16603	black	203 cm	83 cm	18,5 cm	200 L	1	25	

Ref. no.	Description		€
16601	Outlet for footbath / water trough	1/100	

Hoof Mat Standard

- for claws • without sleeve



Ref. no.	Colour	Length	Width	Height			€
16416	blue	180 cm	90 cm	4 cm	1	25	

Ref. no.	Description		€
16414	Cover	1	

Disinfection Mat

- for use at entrances to stables vulnerable to disease • the sturdy, permeable upper material allows liquid to penetrate to the core • impermeable material on the bottom and on the side prevents fluid loss



Ref. no.	Colour	Length	Width	Height	Capacity			€
16418	blue	45 cm	45 cm	3 cm	6 L	1/20	100	
16413	blue	85 cm	60 cm	3 cm	8 L	1	100	

Powder Dispenser

- specially developed for hygienic litter powder like Seche-etable stable drying agent or lime
- suitable for all common screwdrivers (min. 600 rpm, 13 mm chuck)
- the bedding material is evenly distributed in the stalls, saving you a lot of bedding products
- adjustable dispenser opening for precise dosage of lime/powder
- highly productive: 120 boxes of 100 g powder each with one filling
- Filled weight: 8 - 10 kg
- Material container: LDPE
- with carrying strap



Ref. no.	Colour	Max. fill level	Weight		€
291910	blue	12 l	3 kg	1	

Metal Curry Comb

- with 2 knocking-off pieces • robust design • especially suitable for horses
- 8-row • fine-toothed • Material: metal galvanised • Handle material: Plastic

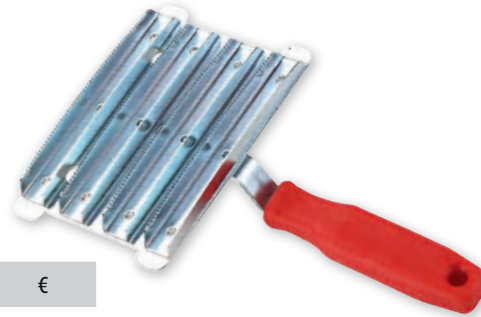

Ref. no.	Length of the curry comb surface	Width of curry comb surface		€
189	9,5 cm	14,5 cm	1/12/48	

Metal Curry Comb

- with 2 knocking-off pieces • especially suitable for cattle • three row • coarsely serrated • Material: metal galvanised • Handle material: Plastic

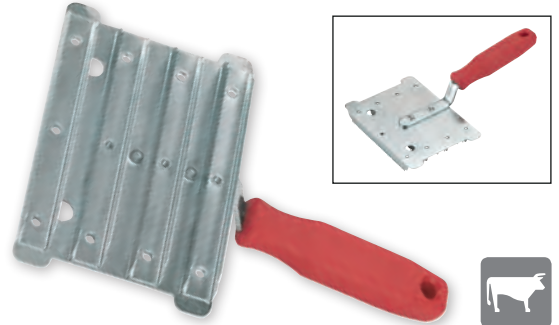

Ref. no.	Length of the curry comb surface	Width of curry comb surface		€
1812	10 cm	14,5 cm	1/12/48	

Spiral Curry Comb

- especially suitable for horses • can be used on both sides • fine-toothed
- Material: stainless steel • Handle material: Plastic



Ref. no.	Ø curry comb surface		€
1815	10,5 cm	1/10/50	

Metal Curry Comb

- half round • two-row • Material: metal galvanised • Handle material: Plastic



Ref. no.	Length of the curry comb surface	Width of curry comb surface		€
1891	5,5 cm	12,5 cm	1/12/48	

Metal Curry Comb

- quadruple wire bearing • 8-row pierced • Material: metal colourless varnish
- Handle material: Wood



Ref. no.	Length of the curry comb surface	Width of curry comb surface		€
1810	11 cm	12,5 cm	1/12	



Top-quality cattle brushes

Cows have a need to rub and scratch themselves. This is how they clean themselves and rid themselves of parasites, lichens and mites. Brushing stimulates and encourages blood circulation. The use of a cow cleaning machine or cattle brush helps considerably to improve the cow's welfare and is therefore essential for a high milk yield. The animals are calmer and their well-being is increased.

Our electric cattle brushes are easy to assemble. A sensor prevents tail hair from getting pulled in. All frame parts are zinc-plated and have been tested in pens under the toughest conditions. In addition, the Duo and Swing Brushes have intelligent control and a display. The extensive

user guide included with every machine contains all the key information on how to put together, maintain and troubleshoot the equipment.

Electric cattle brushes are virtually maintenance-free. The lubrication of pressure points and the prompt replacement of brush rollers extend service life and attractiveness to animals.



A quality product from Kerbl

The cow is cleaned on the head, neck, back, torso and side

Made in Germany



Cattle Brush HAPPYCOW Duo

With the fully automatic Cow Cleaning Machine HAPPYCOW Duo, the cow is happy, willing and fully independently able to wash itself. The animals feel very happy with the 2-brush machine, and it is interesting to see how extensively they brush and massage themselves. The large brushes and massaging action encourages the circulation in the skin and stimulates the metabolism. Milk output is improved and increases the frequency of 'in heat' periods.

- high-quality polyamide brushes ensure a long service life
- newly developed electronics for fault-free and low-maintenance operation
- flexibly installable control unit in spray and dust-proof casing (IP 56)
- informative display for status information
- variable setting options for brush running time (7.5 - 120 s)
- alternating direction of brush movement after each activation (60 s) ensures even wear on the bristles
- optimised brushes ensure that animals are happy to use them
- permanent lubrication over the gears' entire service life
- safety switch-off (torque dependent)
- plug ready for connection to 230 V socket



Technical data	18820
Voltage	230 V
Mains frequency	50 Hz
Power	370 W
Speed	60 rpm
Weight	140 kg
Protection class	IP56
Bristle material	Polyamide

Ref. no.	Colour	Width	Depth	Height	Ø brush		€
18820	red / blue	40 cm	105 cm	115 cm	31,5 - 42 cm	1	

TV

Ref. no.	Description	Material	suitable for			€
18821	Spare Brush top	Polyamide	HappyCow Duo, Kerbl; Schurr; Krazzmaxx	1	24	
18822	Spare Brush below	Polyamide	HappyCow Duo, Kerbl; Krazzmaxx	1	36	
18824	Spare Brush below	Polyamide	Schurr (> 2008)	1	36	



The head and torso are thoroughly cleaned due to the vertical, oscillating shape

Cattle Brush HAPPYCOW Swing

The special arrangement of the CowCleaner Swing brushes in a vertical, swinging direction makes cleaning the coat easier from head to tail. The brush rotates in every direction and nearly every angle, so each part of the animal's body (head, torso) can be reached. It can be fastened on both sides ensuring even use of the brushes. • furthermore, there is no risk of jumping up as with horizontal brushes!

- the HAPPYCOW Swing is automatically activated for approx. 60 seconds by the animals slightly lifting the brush
- the changing direction of the brush after ever activation ensures even wear of the brushes
- the torque safety shutdown stops the brush when it encounters too much resistance, ensuring safety in the stable
- sturdy motor/powertrain for maximum loads
- transparent cover to the control box for quick identification of the operational status on the display
- Material: metal galvanised



Technical data	18880
Voltage	230 V
Mains frequency	50 - 60 Hz
Power	550 W
Speed	50 rpm
Weight	93 kg
Protection class	IP55
Bristle material	Polypropylene

TV

Ref. no.	Width	Depth	Height			€	
18880	50 cm	135 cm	198 cm	1	6		

Ref. no.	Description			€	
18881	Brush for HAPPYCOW Swing	1	6		

Scratch Brush HAPPYCOW MiniSwing

for calves, goats and pigs

The HAPPYCOW MiniSwing automatic scratch brush rotates in any direction and almost every angle. The vertical pendulum brush reaches almost any body part, head and rump especially are thoroughly cleaned. The HAPPYCOW MiniSwing scratch brush is suitable for calves from 3 months of age, adult goats and breeding sows. One brush is designed for max. 40 calves or max. 60 goats and breeding sows.

- the HAPPYCOW MiniSwing is automatically activated for approx. 60 seconds by the animals slightly lifting the brush
- the changing direction of the brush after ever activation ensures even wear of the brushes
- the torque safety shutdown stops the brush when it encounters too much resistance, ensuring safety in the stable
- Material: metal galvanised



Technical data	18890
Voltage	230 V
Mains frequency	50 - 60 Hz
Power	250 W
Speed	27 rpm
Weight	48 kg
Protection class	IP54
Bristle material	Polypropylene

Ref. no.	Colour	Width	Depth	Height			€
18890	red / blue	30 cm	80 cm	125 cm	1	8	

Ref. no.	Description		€
18891	Brush for HAPPYCOW MiniSwing	1	

Scratch Brush

- ensures ideal fur cleaning and care
- head and throat in particular can be cleaned
- suitable for cattle and calves, horses, goats etc.
- various mounting options (walls, corners, stables, posts)
- Bristle material: Polyamide
- Bristle length: 5 cm

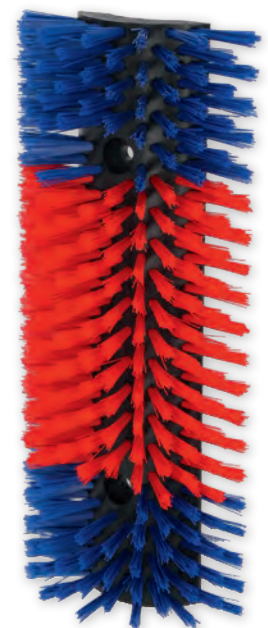
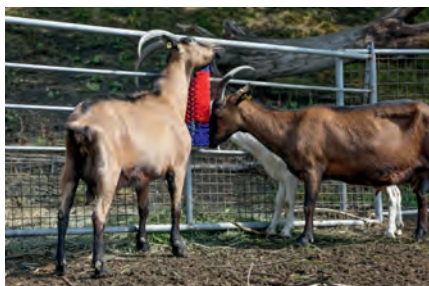

Ref. no.	Colour	Width	Depth	Height		€
293100	red / blue	22 cm	9 cm	50 cm	1	

TV

Scratch Mat

- made from natural rubber material • mobile and soft nubs provide optimum coat care without risk of skin irritation • rectangular shape with many mounting holes for stable mounting • multi-functional applications such as flat on the wall or around pillars, posts or corners

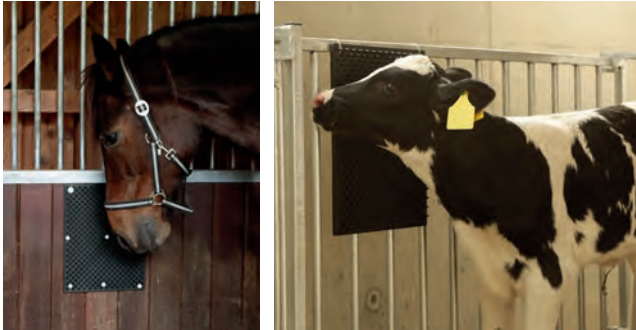

Ref. no.	Colour	Length	Width		€
32678	black	40 cm	30 cm	1/12	
32689	black	60 cm	40 cm	1/6	

Cattle Brush Texas

- stable design with built-in spring • Horizontal brush movable in all directions



Ref. no.	Brush length	Brush width			€
29310	50 cm	10 cm	1	24	

Ref. no.	Description	Length	Width			€
29305	Spare Brush	50 cm	10 cm	1/2	200	
6033	Spring for Texas cattle brush			1	180	

Cattle Brush

- complete with spring • the especially robust design of this brush ensures a high level of user comfort • animals of various sizes can properly scrub themselves • the enormous flexibility even stands up to extraordinary loads (e.g. jumping animals) • special Nylon bristles for fur cleaning and care • stable spring suspension



Ref. no.	Colour	Brush length	Brush width			€
29325	blue / red	50 cm	10 cm	1	24	

Ref. no.	Description	Length	Width			€
29302	Spare Brush	50 cm	10 cm	1/2	200	
29326	Top with spring without brush			1/2	24	

Top Quality

Aesculap Precision Adjusting Aid Torqui for cattle / horse clippers

Every Econom clipping head is child's play to adjust with this torque key.

- precise basic adjustment of the blade pressure
- increased clipping head life thanks to longer intervals between regrinding
- consistent edge-retention
- easy to handle
- no prior knowledge needed
- small, easy to handle, maintenance-free
- precision instrument engineered in Germany
- suitable for all Econom cattle and horse clippers
- all Econom shaving heads can be retrofitted with the knurled screw GT147



TV



If required, the thumbscrew can be adjusted by up to half a turn.
For the perfect shearing blade pressure!

Ref. no.		€
GT146	1/20/200	

Ref. no.	Description		€
GT147	Aesculap Knurled screw for Torqui	1/500	



Aesculap Shearing blades Econom

- very long service life thanks to wear-resistant carbon steel
- cutting surfaces can be reground very often
- resistant surface coating
- ideal hardness thanks to vacuum hardening process
- made on CNC machines, producing consistently high level of quality

Made in Germany



Combination	Upper blade	Lower blade	Teeth	Suitable for
finely serrated	GT501	GT502	15 / 31	Cattle and horses standard cut 3 mm
finely serrated	GT501	GT511	15 / 31	Industrial cut (e.g. fur shearing)
finely serrated	GT505	GT502	23 / 31	Cattle and horses – for smooth standard cut 3 mm
finely serrated	GT505	GT508	23 / 51	Cattle (udder shear), horses and industrial cut (e.g. fur shearing)
finely serrated	GT505	GT511	23 / 31	Cattle and horses – for very fine, smooth cut 1 mm
finely serrated	GT505	GT506	23 / 23	Cattle, dogs and goats 3 mm
medium serrated	GT505	GT507	23 / 21	Cattle, 3 mm
medium serrated	GT505	GT510	23 / 24	Dogs and goats 5 mm
widely serrated	GT503	GT504	17 / 18	Cattle, fine-wool sheep and noble sheep 3 mm

Upper blade



GT501
15 teeth



GT505
23 teeth



GT503
17 teeth

Lower blade



GT502 3,0 mm
31 teeth



GT504 3,0 mm
18 teeth



GT507 3,0 mm
21 teeth



GT506 3,0 mm
23 teeth



GT508 0,1 mm
51 teeth



GT511 1,0 mm
31 teeth



GT510 5,0 mm
24 teeth

Ref. no.	Description	Shearing height	Upper blade teeth	Lower blade teeth	Shearing type		€
GT501	Upper blade		15		Cattle Shearing, Horse Shearing, Standard cut	1/10/100	
GT502	Bottom blade	3 mm		31	Cattle Shearing, Horse Shearing, Standard cut	1/10/100	
GT503	Upper blade		17		Cattle Shearing, Sheep Shearing, fine-wool sheep shearing	1/10/100	
GT504	Bottom blade	3 mm		18	Cattle Shearing, Sheep Shearing, fine-wool sheep shearing	1/10/100	
GT505	Upper blade		23		Horse Shearing, Cattle Shearing	1/10/100	
GT507	Bottom blade	3 mm		21	All-round cut, Cattle Shearing	1/10/100	
GT506	Bottom blade	3 mm		23	Cattle Shearing, Dog Shearing, Goat Shearing	1/10/100	
GT508	Bottom blade	0,1 mm		51	Horse Shearing, Cattle (udder clipping), industrial shearing	1/10/100	
GT511	Bottom blade	1 mm		31	Fine Horse Shearing, Fine Cattle Shearing	1/10/100	
GT510	Bottom blade	5 mm		24	Dog Shearing, Goat Shearing	1/10/100	



Constanta4 clippers

Constanta clippers – developed with the aim of building the perfect clipper:

- Their weight, centre of gravity and shape have been selected to ensure that working with them is as fatigue-free as possible
- Optimised ventilation technology provides perfect cooling of the cutter head and shearing blades
- Service-friendly shell housing
- Air filter can be replaced without tools

Made in Germany



Animal Clipper constanta4

- the tried-and-tested motor technology gives the constanta4 tremendous tractive power • even on matted and dirt-encrusted animals the constanta4 does not „yield“
- the blades glide through the most difficult of coats without loss of power



Included in delivery: 1 x animal clippers constanta4, 1 x clipper blade set, 1 x oil, 1 x screwdriver, 1 x instruction manual, 1 x Durable plastic case



Technical data	
Voltage	230 V AC
Mains frequency	50 - 60 Hz
Power	400 W
Clipper head system	Shearing Blade Set
Stroke rate	approx. 2.400 strokes/min
Sound pressure level	87 dB (A)
Cable length	3 m
Dimensions	33 x 7,8 x 9,7 cm
Weight	1.490 g without cable
Protection class	II

Ref. no.	Colour	Teeth lower/upper blade	Shearing type			€
18990	green	21 / 23	Cattle Shearing, Horse Shearing	1/8	48	
18991	green	31 / 15	Cattle Shearing, Horse Shearing	1/8	48	

Shearing Blade Set Premium

- optimised blade geometry with hollowed grinding • Improved grinding capacity and increased material service life for long periods of use
- Selected steel tool with special hardening • suitable for constanta, FarmClipper and other common brands, such as Heiniger, Aesculap and Liscop

made by Aesculap



18955 Premium Shearing Blade Set 21/23 All-round blade for difficult fleece conditions (dirty, matted) in cattle and dairy cows, residual hair length 2–4 mm



18959 Premium Shearing Blade Set 18/17 for shearing cattle with thick coats and fine-wool sheep, residual hair length approx. 2–4 mm



18956 Premium Shearing Blade Set 31/15 for cutting the clean to slightly soiled coats of horses and cattle, residual hair length 2–4 mm



18957 Premium Shearing Blade Set 31/23 for udder or especially fine shearing of cattle and dairy cows, and for the fine shearing of horses, residual hair length 2–4 mm



18958 Premium Shearing Blade Set 31F/15 for fine and veterinary shearing very close to the skin, residual hair length 1–2 mm

Ref. no.	Description	Upper blade teeth	Lower blade teeth	Shearing type	MOQ	Pieces / unit		€
18955	Cow	23	21	All-round Cattle Shearing, extremely dirty animals	1 blister pack	1 / blister pack	1/100	
18959	Cow	17	18	fine-wool sheep shearing, Cattle Shearing	1 blister pack	1 / blister pack	1/50	
18956	Cattle / Horse	15	31	slightly dirty animals, Horse Shearing, Cattle Shearing	1 blister pack	1 / blister pack	1/100	
18957	Cattle / Horse	23	31	Udder Clipping, Fine cut	1 blister pack	1 / blister pack	1/100	
18958	Cow	15	31	Fine cut, skin-level, for vets	1 blister pack	1 / blister pack	1/100	

Animal Clipper constanta4

- Special clippers for cattle with difficult coat conditions • ideally suited for shearing lamas and alpacas • technology based on the Constanta4 sheep clippers

Technical data	18989
Voltage	230 V
Mains frequency	50 - 60 Hz
Power	400 W
Clipper head system	Shearing Blade Set
Stroke rate	approx. 2.400 strokes/min
Sound pressure level	87 dB
Cable length	3 m
Dimensions	34 x 10 x 6 cm
Weight	1.510 g without cable
Protection class	II



Included in delivery: 1 x animal clippers constanta4, 1 x clipper blade set, 1 x small oil bottle, 1 x screwdriver, 1 x instruction manual, 1 x Durable plastic case

Ref. no.	Colour	Teeth lower/upper blade	Shearing type			€
18989	green	20 / 4	Lama Shearing, Alpaca Fleece, Cattle Shearing	1/8	48	

Ref. no.	Description	Lower blade teeth	Upper blade teeth		€
18978	Shearing blades Upper blade		4	1/50	
18534	Shearing blades Bottom blade	20		1/50	



Cordless Clipper FarmClipper Akku2

The new battery-powered clipper designed for horses or cattle boasts exceptional value for money! The supplied package includes two 14.4 Volt Lithium ion block batteries, which allow uninterrupted shearing thanks to their optimised operating and charging times. The ergonomic characteristics of the FarmClipper Akku2 are also plain to see: the special surface properties of the housing shells and the balanced centre of gravity prevent the user from tiring too quickly. The size of the plastic shells also means that even small hands can be sure of a firm grip on the clipper. The FarmClipper Akku2 is a clipper with fantastic all-round properties boasting excellent handling.

- available in horse and cattle versions • special, non-slip housing shell for low-fatigue work
- balanced centre of gravity ensures effortless shearing



Technical data	
Voltage	14,4 V
Stroke rate	approx. 2.300 strokes/min
Battery technology	Li-Ion
Battery voltage	14,4 V
Battery run time	90 min
Battery charge time	90 min
Dimensions	28,5 x 8 x 8 cm
Weight	1.090 g incl. battery

incl. replacement battery

Included in delivery: 1 x clipper FarmClipper Akku2, 1 x clipper blade set, 2 x batteries 14.4 Volt, 1 x small oil bottle, 1 x screwdriver, 1 x charging station, 1 x instruction manual, 1 x Durable plastic case

Ref. no.	Description	Colour	Teeth lower/upper blade	Shearing type			€
181881	incl. 2 batteries	blue	31 / 15	Horse Shearing	1/3	72	
181891	incl. 2 batteries	blue	21 / 23	Cattle Shearing	1/3	72	

Ref. no.	Description	Lower blade teeth	Upper blade teeth	MOQ	Pieces / unit		€
181911	Spare Battery for Clippers FarmClipper Akku2					1	
18955	Shearing Blade Set Premium Cow	21	23	1 blister pack	1 / blister pack	1/100	
18956	Shearing Blade Set Premium Cattle / Horse	31	15	1 blister pack	1 / blister pack	1/100	



Clipper FarmClipper4

- even very dirty animals or matted fur are no obstacle to the new FarmClipper4 • universal shearing machine for cattle and horses • optimised weight distribution for low-fatigue working • attractive, ergonomic design
- powerful motor delivering 200 Watt DC

Technical data		18192
Voltage		220 - 240 V AC
Mains frequency		50 - 60 Hz
Clipper head system		Shearing Blade Set
Drive		DC motor
Stroke rate		approx. 3.000 strokes/min
Sound pressure level		85 dB
Dimensions		29,5 x 8 x 6,2 cm
Weight		1.190 g without cable
Protection class		II



Permanent Magnet System: 200 Watt DC = 400 Watt AC

Included in delivery: 1 x clipper FarmClipper4, 1 x clipper blade set, 1 x screwdriver, 1 x instruction manual, 1 x Durable plastic case

Ref. no.	Colour	Teeth lower/upper blade	Shearing type			€
18192	blue	31 / 15	All-round cut	1/3	108	

Ref. no.	Description	Lower blade teeth	Upper blade teeth	MOQ	Pieces / unit		€
18956	Shearing Blade Set Premium Cattle / Horse	31	15	1 blister pack	1 / blister pack	1/100	

Aesculap BladeCool



- highly effective, technical spray that immediately cools and cleans the blade set
- easy to use: simply spray on before, during and after using the blade set
- improves the cutting result and keeps the shearing blades and cutter head sharp longer
- removes hair and fur residue as well as dirt



Please note the use and safety instructions.

After the spray is used, the cutter head should be oiled.

Please note the use and safety instructions.

Ref. no.	Contents			€
GTA100	500 ml / Spray Can	1/12	1.008	

Aesculap Clipper Oil

Specialist oil for all Aesculap clippers and for all moving parts on and in the clipping head.



Ref. no.	Contents		€
GT604	90 ml / Bottle	1/100	

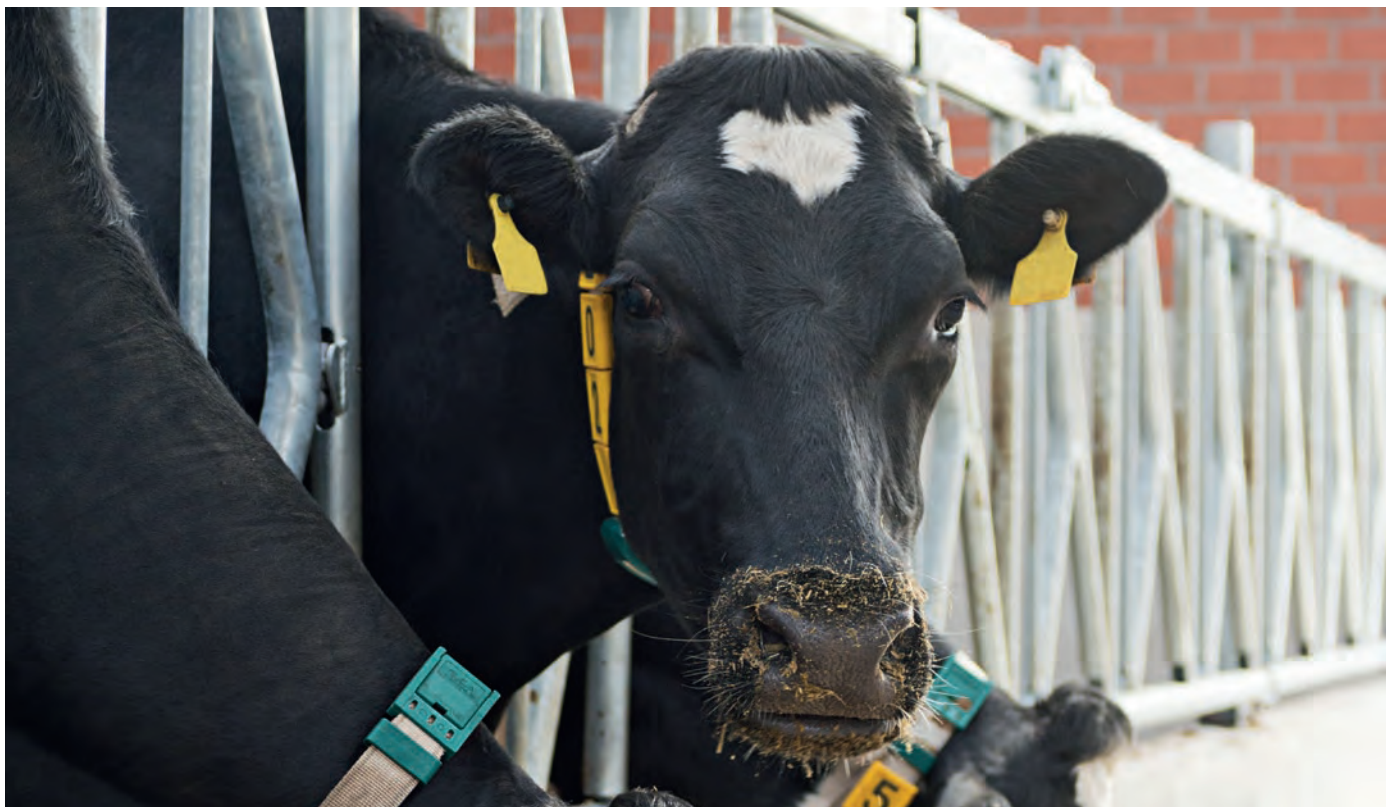



Cordless Clipper DeloX

- 3 cutting speeds • excellent clipping properties thanks to stainless steel clipping head
- high-quality, long-lasting motor • digital display of the charging status, oiling, cleaning and remaining battery capacity • can also be operated with power pack connected • with powerful li-ion 2200 mAh battery • Clipping height adjustment: 5-tier adjustable with setting wheel

Included in delivery: 1 x cordless clippers DeloX, 4 x clip-on combs (3,6, 9, 12 mm), 1 x cleaning brush, 1 x power pack, 1 x charging station, 1 x oil, 1 x instruction manual

	2200 mAh Li-Ion
	38 mm
	0,8 - 2,0 mm
	4 x 3 mm 6 mm 9 mm 12 mm
	Speed
	LED



Technical data	18463
Voltage	5 V DC
Clipper head system	SnapOn
Stroke rate	approx. 4.000 strokes/min / approx. 5.000 strokes/min / approx. 6.000 strokes/min
Battery technology	Li-Ion
Battery capacity	2.200 mAh
Battery run time	300 min
Battery charge time	300 min
Shear width	38 mm
Shearing height	0,8 mm / 1,1 mm / 1,4 mm / 1,7 mm / 2 mm
Weight	242 g without cable
Protection class	III



Ref. no.	Colour	Shearing type	Shear width		€
18463	black	Detailed shearing	38 mm	1/6/24	

Ref. no.	Description		€
18477	Stainless Steel Clipping Head for DeloX	1/500	

Marking Spray TopMarker

- for marking cattle or pigs and goats • colourful and fast-drying marking, highest quality • we recommend our special sheep marking spray for sheep

Quick-drying and colour-intensive!



Ref. no.	Colour	Contents			€
20122	green	200 ml / Spray Can	1/12		2.880
20123	blue	200 ml / Spray Can	1/12		2.880
20124	red	200 ml / Spray Can	1/12		2.880
20148	green	400 ml / Spray Can	1/12		1.512
20149	blue	400 ml / Spray Can	1/12		1.512
20150	red	400 ml / Spray Can	1/12		1.512
20157	green	500 ml / Spray Can	1/12		1.344
20158	blue	500 ml / Spray Can	1/12		1.344
20156	red	500 ml / Spray Can	1/12		1.344
20173	orange	500 ml / Spray Can	1/12		1.344
20174	violet	500 ml / Spray Can	1/12		1.344
20177	black	500 ml / Spray Can	1/12		1.344



Cattle Marking Pen TopMarker

- for the short-term marking of pigs, sheep and cattle • Paints with high coverage • extremely economical • easy to use thanks to tommy bar

Available in customer-specific composition. Note the instructions at the end of the catalogue.

Ref. no.	Colour	Contents	MOQ	Pieces / unit			€
20620	blue	60 ml / Tommy Bar	10 pieces	10 / pack	1/10/100		4.200
20620/2	blue	60 ml / Tommy Bar	1 blister pack2 / blister pack			1	
20621	red	60 ml / Tommy Bar	10 pieces	10 / pack	1/10/100		4.200
20621/2	red	60 ml / Tommy Bar	1 blister pack2 / blister pack			1	
20622	green	60 ml / Tommy Bar	10 pieces	10 / pack	1/10/100		4.200
20622/2	green	60 ml / Tommy Bar	1 blister pack2 / blister pack			1	
20623	yellow	60 ml / Tommy Bar	10 pieces	10 / pack	1/10/100		4.200
20624	orange	60 ml / Tommy Bar	10 pieces	10 / pack	1/10/100		4.200
20625	violet	60 ml / Tommy Bar	10 pieces	10 / pack	1/10/100		4.200
20626	black	60 ml / Tommy Bar	10 pieces	10 / pack	1/10/100		4.200



Aerosol grip SprayMaster

for marking spray

- the spraying aid for comfortable application of colour and marking sprays
- for clean and efficient work with all common spray can types • the spraying aid permits professional handling similar to using a gun and helps you to work effortlessly on larger areas • protects the worker's hands



Ref. no.		€
20170	1/135	

Cattle Marking Scissors

- upturned tip • Material: stainless steel

Ref. no.	Length		€
208	19 cm	1/10/300	



Fetlock strap

The ORIGINAL

- for long-term marking • unlabelled • for marking cows in pens • Material: Plastic
- steplessly adjustable



Available in customer-specific composition. Note the instructions at the end of the catalogue.

Ref. no.	Colour	Length	MOQ	Pieces / unit		€
20110	yellow	37 cm	10 pieces	10 / pack	1/10/200	
20111	red	37 cm	10 pieces	10 / pack	1/10/200	
20112	blue	37 cm	10 pieces	10 / pack	1/10/200	
20113	green	37 cm	10 pieces	10 / pack	1/10/200	
20114	orange	37 cm	10 pieces	10 / pack	1/10/200	

TV

Easy to open by hand!

Fetlock Marking Tape

- for marking cows e.g. dry areas, mastitis, hoof treatment etc. • with hook and loop fastener

20895: mixed colours (3 x yellow, 3 x red, 2 x blue, 2 x green)

Ref. no.	Colour	Length	MOQ	Pieces / unit		€
2089	yellow	36 cm	1 blister pack	10 / blister pack	1/100	
20892	red	36 cm	1 blister pack	10 / blister pack	1/100	
20893	blue	36 cm	1 blister pack	10 / blister pack	1/100	
20894	green	36 cm	1 blister pack	10 / blister pack	1/100	
20895	mixed	36 cm	1 blister pack	10 / blister pack	1/100	



Fetlock strap for pedometer

- compatible with all common pedometers (including GEA/Nedap, Lemmer-Fullwood)
- with ring fastener

Ref. no.	Colour	Length	Width		€
20102	blue	40 cm	4 cm	1/10/400	



Leg band numbers

1-digit

- for looping in • optimal recognisability thanks to practical colour code • makes animal identification easier during milking • made from a flexible material to prevent pressure points • suitable for fetlock straps up to 30 mm wide • suitable fetlock strap item no. 20103
- Dimensions: 36 x 36 mm

Ref. no.	Number	Colour	MOQ	Pieces / unit		€
208420	0	black	1 pack	10 / pack	1/45	
208421	1	yellow	1 pack	10 / pack	1/45	
208422	2	orange	1 pack	10 / pack	1/45	
208423	3	red	1 pack	10 / pack	1/45	
208424	4	violet	1 pack	10 / pack	1/45	
208425	5	blue	1 pack	10 / pack	1/45	
208426	6	green	1 pack	10 / pack	1/45	
208427	7	grey	1 pack	10 / pack	1/45	
208428	8	brown	1 pack	10 / pack	1/45	
208429	9	white	1 pack	10 / pack	1/45	



Fetlock strap for leg band numbers

- with ring fastener

Ref. no.	Colour	Length	Width		€
20103	blue	30 cm	3 cm	1/10/500	



Weight for ear marking tape

- keeps the neck marking strap in the correct position • with metal core surrounded by impact-resistant plastic • suitable for neck marking straps up to 40 mm wide • incl. oval link

Ref. no.	Colour	Weight		€
20810	green	500 g	1/10	



Numbering block Standard

1-digit

- for looping in • suitable for neck marking straps up to 40 mm wide • Set of 10 • Dimensions: 44 x 46 mm



MOQ	Pieces / unit		€
10 pieces	10 / pack	1/10/1.000	

Number	0	1	2	3	4	5	6 / 9	7	8
yellow	208480	208481	208482	208483	208484	208485	208486	208487	208488
orange	208460	208461	208462	208463	208464	208465	208466	208467	208468
red	208470	208471	208472	208473	208474	208475	208476	208477	208478

Collar Number Duo

1-digit

- effortless attachment and removal thanks to two-part design
- optimised recognisability thanks to handy colour code, double-sided labelling and large format (54 x 59 mm)
- suitable for neck marking straps up to 40 mm wide
- patented

Made in Germany



Hugely reduced workload

Collar numbers Duo are a huge help, especially if there are livestock changes. Conventional collar numbers must be pushed from the collar which, due to dirt and soiling, is extremely difficult or even impossible after just a short period of use. Sometimes, the collar – including equipment such as transponders, sensors or weights – must be completely dismantled, simply for changing just one number. By contrast, collar numbers Duo can be opened, removed and inserted in the required position easily. With tethered animals, they can be even be fitted without removing the collar.

Optimum recognisability

The special colour coding (one colour for each number) and large format make animal recognition much easier, especially at long distances, with partially concealed digits or in poor lighting conditions. Thanks to the double-sided labelling and colour coding, even twisted collars are no longer a problem.

Ref. no.	Number	Colour	MOQ	Pieces / unit		€
209420	0	black	1 pack	6 / pack	1/45	
209421	1	yellow	1 pack	6 / pack	1/45	
209422	2	orange	1 pack	6 / pack	1/45	
209423	3	red	1 pack	6 / pack	1/45	
209424	4	violet	1 pack	6 / pack	1/45	
209425	5	blue	1 pack	6 / pack	1/45	
209426	6	green	1 pack	6 / pack	1/45	
209427	7	grey	1 pack	6 / pack	1/45	
209428	8	brown	1 pack	6 / pack	1/45	
209429	9	white	1 pack	6 / pack	1/45	



Accessories Collar Number Duo

20944: for easier insertion and removal of the pin

Ref. no.	Description	Material	MOQ	Pieces / unit		€
20943/12	Spare Pins	Plastic	1 pack	12 / pack	1	
20944	Installation tools				1/100	

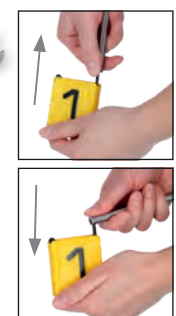

Numbering block

for neck marking

The numbering block is positioned upright on the animal's neck, making it very easy to recognise. Side-mounted collar numbers are often hidden in the stable and cannot be seen by the farmer. The numbering block is positioned upright on the animal's neck, making it very easy to recognise the animals, especially in cubicles or at the feeding fence, where a side-attached number can often not be seen.

- especially stable
- for looping in
- suitable for neck marking straps up to 40 mm wide

Ref. no.	Labelling	Colour	Series of numbers	MOQ	Pieces / unit		€
208430	plain	yellow		1 pack	25 / pack	1/100	
208431	printed	yellow	1 - 25	1 pack	25 / pack	1/100	
208432	printed	yellow	26 - 50	1 pack	25 / pack	1/100	
208433	printed	yellow	51 - 75	1 pack	25 / pack	1/100	
208434	printed	yellow	76 - 100	1 pack	25 / pack	1/100	
208435	printed	yellow	101 - 125	1 pack	25 / pack	1/100	
208436	printed	yellow	126 - 150	1 pack	25 / pack	1/100	
208437	printed	yellow	151 - 175	1 pack	25 / pack	1/100	
208438	printed	yellow	176 - 200	1 pack	25 / pack	1/100	
208439	printed	yellow	201 - 225	1 pack	25 / pack	1/100	
208440	printed	yellow	226 - 250	1 pack	25 / pack	1/100	
208441	printed	yellow	251 - 275	1 pack	25 / pack	1/100	
208442	printed	yellow	276 - 300	1 pack	25 / pack	1/100	

New product

NEW





Available in customer-specific composition. Note the instructions at the end of the catalogue.

Marking collar

• with roller buckle

20887

20866

20868



Made in Germany



Top Seller

Ref. no.	Colour	Length	Width		€
20887	white / black	90 cm	40 mm	1/10/150	
20889	white / black	120 cm	40 mm	1/10	
20878	white / black	135 cm	40 mm	1/10	
20898	green / white	120 cm	40 mm	1/10	
20866	green / white	135 cm	40 mm	1/10	
20868	blue	120 cm	40 mm	1/10	
20869	blue	135 cm	40 mm	1/10	

Marking collar

• with ring fastener

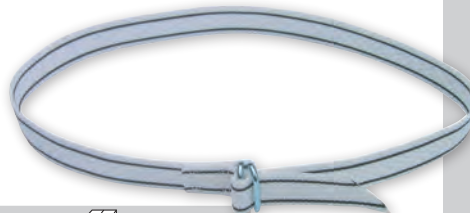

Made in Germany



Ref. no.	Colour	Length	Width		€
2088	white / black	130 cm	40 mm	1/10	

Marking collar

• with clip fastener

20923

20925

20921

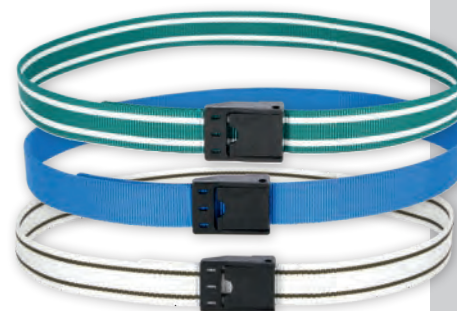

Made in Germany



Ref. no.	Colour	Length	Width		€
20923	green / white	130 cm	40 mm	1/10	
20925	blue	130 cm	40 mm	1/10	
20921	white / black	130 cm	40 mm	1/10	
20924	green / white	90 cm	40 mm	1/10	
20926	blue	90 cm	40 mm	1/10	

Delizia® Mineral Lick Equisal NoFly

Mineral lick based on sea salt for natural insect deterrence with natural ingredients. The animal is also provided with minerals, trace elements and vitamins as required individually.

- consists of highly digestible and high quality food-grade Mediterranean salt
- can deter annoying insects such as flies, mosquitoes and fleas
- can promote blood circulation and support the immune system
- promotes the maintenance of a neutral stomach pH
- antioxidant effect through the minerals iron, selenium, zinc, manganese and vitamin E
- can improve digestion and metabolism
- can reduce the stress factor that is triggered by annoying insects



New product

NEW

Ref. no.	Single weight	MOQ	Pieces / unit		€
325670	3 kg	4 pieces	4 / box	1/4	

Delizia® Salt Lick

- pressed rock crystal salt lick
- contains minerals and trace elements
- dimensions approx. 20 x 10 x 5 cm (L x W x H) per lick

Ref. no.	Single weight	MOQ	Pieces / unit		€
324804	2 kg	1 box	4 / box	1	



Lick holder

- practical, virtually indestructible lick holder for angular licks
- incl. reinforced mounting holes
- suitable for 2 kg salt lick (324804) and angular salt or mineral licks of max. 10 x 5 cm
- made of robust plastic
- screw in or nail on

Ref. no.	Colour			€
324803	black	1/60	800	



Lick holder



- innovative lick holder made from shock-resistant plastic
- for various lick types in round or square shape
- screw-on fastening

32480: with removable insert for round licks up to 3 kg e.g. Equisal

Made in the EU



patented

Ref. no.	Colour	Length	Width	Lick Insert			€
32479	dark green	18,5 cm	19 cm	without insert	1	150	
32480	dark green	18,5 cm	19 cm	with round insert	1	150	





Lick holder

- no sharp edges
- also suitable for 15 kg salt stones
- Internal dimensions: 191 x 194 mm
- Material: Plastic
- screw in or nail on

Made in the EU



Ref. no.	Colour	Length	Width	Lick Insert			€
324793	black	20,2 cm	20,6 cm	without insert	1	275	
324794	aquamarine	20,2 cm	20,6 cm	without insert	1	275	
324795	rosé	20,2 cm	20,6 cm	without insert	1	275	



Lick holder

- Material: metal galvanised

Ref. no.	Length	Width	Height			€
32472	20,5 cm	20,5 cm	23,5 cm	1	150	

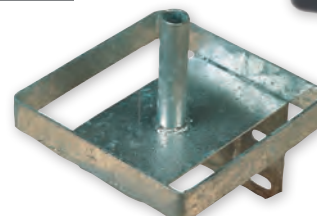

Calf and Sheep Trough

- ideal for feeding during the drinking period

Made in the EU



Ref. no.	Width	Depth	Height	Capacity			€
3257	23 cm	22 cm	21 cm	6 L	1	200	



Trough for concentrated feed

- shatter-proof plastic • with drain plug



Top Seller

Ref. no.	Colour	Width	Depth	Height	Capacity			€
32460	dark green	33 cm	28 cm	33,5 cm	9 L	1	150	



Feed trough

- shatter-proof plastic • square



Top Seller

Ref. no.	Description	Colour	Width	Depth	Height	Capacity			€
3258	without protective edge	green	42 cm	30 cm	32 cm	15 L	1	100	
32582	with protective edge (unmounted!)	green	42 cm	30 cm	32 cm	15 L	1	100	



Ref. no.	Description		€
32581	Protective Edge	1/25	

Feed trough Corner Model

- complete with feed saver and bite protecting edge (not mounted)
- Material: Plastic • for corner mounting

Ref. no.	Colour	Width	Depth	Height	Capacity			€
32592	green	60 cm	45 cm	30 cm	31 L	1	50	

Ref. no.	Description		€
32591	Protective Edge for feeding trough corner model	1/25	



Feed trough with metal pins

- shatter-proof plastic • the metal rods can be removed with a few simple steps
- with drain plug

Ref. no.	Colour	Width	Depth	Height	Capacity			€
32465	green	33 cm	28 cm	33,5 cm	9 L	1	30	



Feeding Troughs

Rectangular Trough

• extremely durable and keeps its shape • additional protection against injuries due to continuous round tubes • Material: metal hot-dip galvanised • with drain plug 15 mm



Ref. no.	Length	Width	Height	Capacity			€
32483	45 cm	34 cm	24 cm	35 L	1	16	

Triangular Trough

• extremely durable and keeps its shape • additional protection against injuries due to continuous round tubes • Material: metal hot-dip galvanised • for corner mounting • with drain plug 15 mm



Ref. no.	Length	Width	Height	Capacity			€
32482	44 cm	44 cm	24 cm	35 L	1	16	

Round Trough

• extremely durable and keeps its shape • additional protection against injuries due to continuous round tubes • Material: metal hot-dip galvanised • with drain plug 15 mm



Ref. no.	Length	Width	Height	Capacity			€
32484	55 cm	35 cm	24 cm	28 L	1	16	

Plug for feeding troughs

• easy and secure to screw in thanks to M12 x 18 thread • suitable for Troughs 32460, 32465, 32482, 32483, 32484, 32490, 32495, 32496



Ref. no.		€
32498	1/100/300	

Square hay rack Standard

- suitable for round and rectangular bales up to 1.8 m in length or diameter • 1 x square tubular support • 2 sides can easily be opened for filling • three-point attachment • very little food loss • supplied as a construction kit including circumferential roof edge protection, three-point safety clip • Internal trough dimensions: approx. 1.9 x 1.9 m
- Material: metal hot-dip galvanised



Circumferential roof edge protection



Three point attachment (with safety guard)



Please note separate freight costs.

Ref. no.	Description	Length	Width	Height	Feed areas			€	
291289	with palisade feeding grate for horses and cattle	230 cm	230 cm	250 cm	12	1	6		
291294	with self-closing feeding grate for hornless cattle	230 cm	230 cm	250 cm	12	1	6		

Ref. no.	Description	Material			€	
291299	Self-Closing Feeding Grate single	metal hot-dip galvanised	1	6		



Hay Bell for round bales

- for round bales with max. \varnothing 160 x H 125 cm or \varnothing 130 x H 135 cm
- shatter-proof, frost-proof plastic material with built-in UV protection
- sturdy construction • with animal-friendly and non-damaging food openings
- water-removing rain channels over the food openings
- with integrated carrying handle, suitable for front loader forks
- with integrated fixing eyelets for fixing the base to the hay bell
- Base (available separately) for dry storage of the bales; can be locked for transportation with the hay bell



Technical data	14557	14558
Height	164 cm	164 cm
Exterior diameter	185 cm	185 cm
Interior diameter	160 cm	160 cm
Feed areas	5	10

Please note separate freight costs.

Ref. no.	Colour	Suitable for			€	
14557	olive green	Cattle / Horses	1	6		
14558	olive green	Sheep / Goats / Calves / Ponies	1	6		



Ref. no.	Description	Colour	Material	suitable for		€	
14559	Ground for hay bell	olive green	Plastic UV-stabilised	14557, 14558	1		
14556	Ground anchor for hay bell and base			14557, 14558, 14559	1/10		

Square hay rack Hobby

- suitable for round and rectangular bales up to 1.4 m in length or diameter
- 1 x square tubular support
- 2 sides can easily be opened for filling
- three-point attachment
- very little food loss
- supplied as a construction kit including circumferential roof edge protection, three-point safety clip
- Internal trough dimensions: approx. 1.50 x 1.50 m
- height-adjustable runners (adjustable to the animal's size)
- Material: metal hot-dip galvanised



Please note separate freight costs.

Ref. no.	Length	Width	Height	Feed areas			€	
291300	150 cm	150 cm	240 cm	8	1	6		



Round hay rack with 8 feeding places

for loose feed or small high-pressure bales

- palisade feeding grid
- supplied as a kit
- 4-part, can be transported in an estate car
- outdoors or in play pens, the segments can also be used to set up wall or corner mangers
- no three-point hitch
- Material: metal hot-dip galvanised

Technical data	291257
Material	metal hot-dip galvanised
Height	116 cm
Exterior diameter	150 cm
Interior diameter	132,5 cm
Feed areas	8

Please note separate freight costs.

Ref. no.			€	
291257	1	5		





Pasture Panel

- perfect for erecting mobile and flexible fencing as well as temporary horse boxes • also commonly used to fence off riding and training areas • also suitable for constructing trap systems and gangways • height of upper tube 1.6 m • safety mounting bracket prevents animals from being injured. When landing on the panel, the animal does not fall between two panels if it slips • made from flat oval pipe 50 x 30 mm
- clear distance between tubes 20 cm • rapid chain fastening makes it quicker and easier to connect several panels • very stable at light loads • curved feet ensure excellent stability

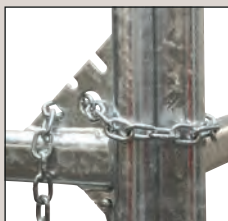

Rapid chain fastening, hot-dip galvanised



Safety mounting bracket





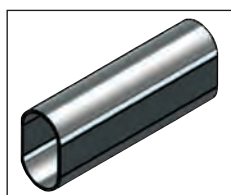



curved feet ensure excellent stability



Flat Oval Pipe

Please note separate freight costs.

Ref. no.	Description	Material	Length	Height			€	
442591	Pasture Panel without gate	metal hot-dip galvanised	240 cm	170 cm	1	48		
442592	Pasture Panel without gate	metal hot-dip galvanised	300 cm	170 cm	1	36		
442593	Pasture Panel without gate	metal hot-dip galvanised	360 cm	170 cm	1	18		

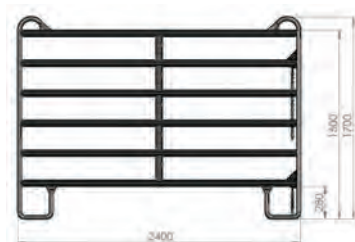

442591



442592

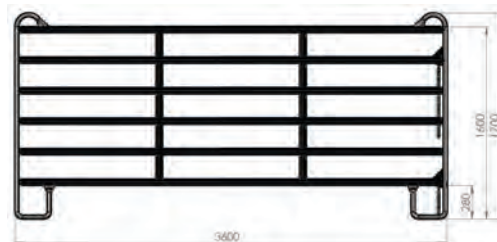

442593

Pasture Panel with Gate

- allows an opening to be created in the fencing • gate width 1 m • lock for opening and closing the fenced area





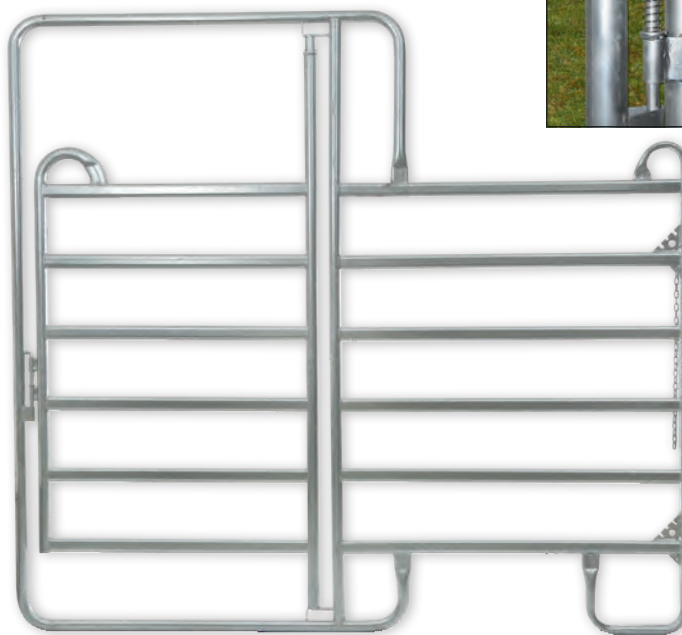

Locking bolt



Example for mounting



Please note separate freight costs.

Ref. no.	Description	Material	Length	Height			€	
442594	Pasture Panel with Gate	metal hot-dip galvanised	240 cm	220 cm	1	18		
442595	Pasture Panel with Gate	metal hot-dip galvanised	300 cm	220 cm	1	18		
442596	Pasture Panel with Gate	metal hot-dip galvanised	360 cm	220 cm	1	18		

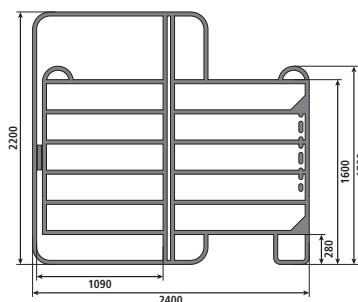

442594

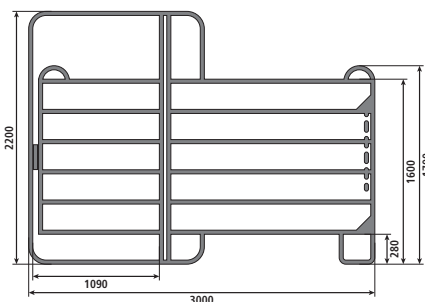

442595

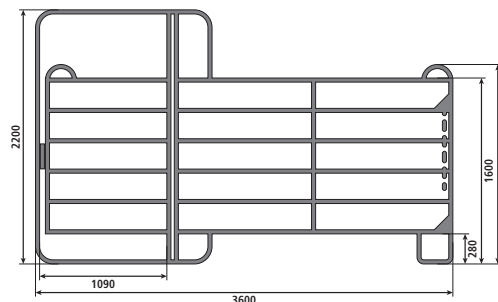

442596

Extension element

for constructing gangways and mobile treatment facilities

- potential uses, such as immunisations, ear tag control or loading and sorting the herd







442620

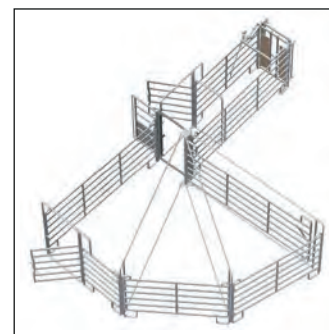

442621



Example for mounting

Ref. no.	Description	Material	Width	Height		€	
442620	Extension element Sliding door, single	metal hot-dip galvanised	85 cm	200 cm	1		
442621	Extension element Connector frame for panels	metal hot-dip galvanised	85 cm	186 cm	1		

Water Bowl E21 with pipe valve

- with drinking bowl made of stainless steel, pipe valve and robust cast iron body
- ideal for dairy cows, as results in a large water flow
- extra-large and wide bowl (Ø 27 cm, height 12 cm)
- Stainless steel ensures optimum water hygiene
- 4-point fastening on wall or pipe
- Fastening material not included



22365



Technical data	221860	2218605
Connection option	from above or below	from above or below
Flow rate	14 L/min at 3 bar, 20 L/min at 5 bar	14 L/min at 3 bar, 20 L/min at 5 bar

Ref. no.	Water connection	Capacity			€
221860	G 1/2"	5 L	1	60	
2218605	G 3/4"	5 L	1	60	

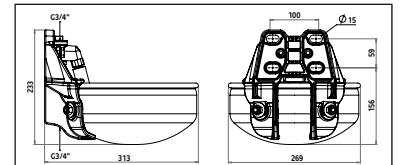

Ref. no.	Description	Material		€
22365	Mounting Bracket in pairs	metal	1/25	
221861	Valve		1/20	
221971	Guard Size 2	metal hot-dip galvanised	1/4	

Water Bowl G51 with pipe valve

- large drinking bowl made of grey cast iron
- high-quality enamelled surface
- easy to clean bowl shape
- for wall and pipe mounting



22365



Technical data	221851
Connection option	from above or below
Flow rate	8 L/min at 3 bar

enamelled

Ref. no.	Colour	Water connection	Capacity			€
221851	black	G 1/2"	1,7 L	1	84	

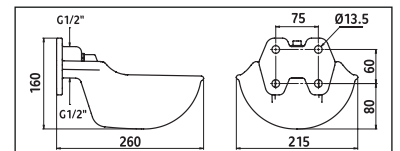

Ref. no.	Description	Material		€
221885	Pipe Valve Set		1/20	
22365	Mounting Bracket in pairs	metal	1/25	
221970	Guard Size 1	metal hot-dip galvanised	1/4	

Water Bowl K75

- controllable water flow rate (up to max. 11 litres/minute)
- with outlet plug for easy cleaning
- for wall and pipe mounting
- with drain plug
- Material: Polypropylene

Technical data	
Connection option	from above or below
Flow rate	11 L/min at 3 bar

Ref. no.	Colour	Water connection	Capacity			€
221875	green	G 1/2"	2,8 L	1	60	
221876	green	G 3/4"	2,8 L	1	60	

Ref. no.	Description	Material		€
222019	Pipe Mounting Bracket in pairs	metal powder-coated	1	
221971	Guard Size 2	metal hot-dip galvanised	1/4	

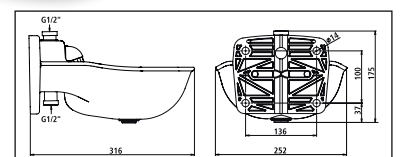

Water Bowl Mod. 221500

• large drinking bowl made of grey powder-coated cast iron • for wall and pipe mounting

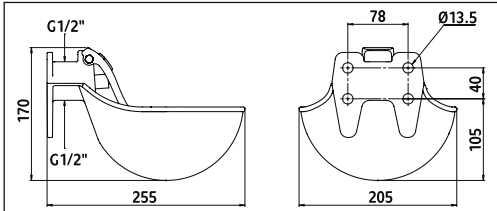

Technical data

Dimensions (W x D x H)	20,5 x 25,5 x 17 cm
Connection option	from above or below
Flow rate	5 L/min at 3 bar
Weight	3,7 kg



Ref. no.	Colour	Water connection	Capacity	MOQ	Pieces / unit			€
221500	black	G 1/2"	1,45 L	2 pieces	2 / box	1/2	96	
221501	black	G 1/2"	1,45 L			1	105	

Ref. no.	Description	Material	MOQ	Pieces / unit		€
22202	Valve	brass			1/10/400	
22202/1	Valve	brass	1 blister pack	1 / blister pack	1	
22210	mounting plate	metal			1/100	
221970	Guard Size 1	metal hot-dip galvanised			1/4	

Water Bowl G16 with stainless steel guide

• Drinking bowl made of grey cast iron, enamelled • individually packed • for wall and pipe mounting

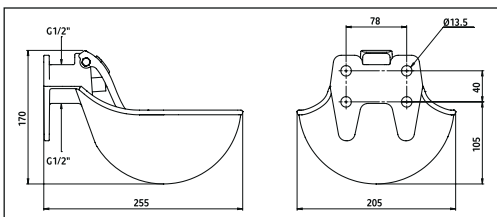

enamelled



Technical data	221600
Dimensions (W x D x H)	20,5 x 25,5 x 17 cm
Connection option	from above or below
Flow rate	5 L/min at 3 bar
Weight	3,7 kg



Ref. no.	Colour	Water connection	Capacity			€
221600	black	G 1/2"	1,45 L	1	120	

Ref. no.	Description	Material	MOQ	Pieces / unit		€
22202	Valve	brass			1/10/400	
22202/1	Valve	brass	1 blister pack	1 / blister pack	1	
22210	mounting plate	metal			1/100	
221970	Guard Size 1	metal hot-dip galvanised			1/4	

Water Bowl Mod. 222000

- large drinking bowl made of grey powder-coated cast iron
- lockable paddle • for wall and pipe mounting



lockable paddle

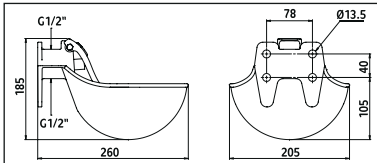

Technical data	222000
Dimensions (W x D x H)	20,5 x 26 x 18,5 cm
Connection option	from above or below
Flow rate	5 L/min at 3 bar
Weight	4,5 kg



22202



22210



Ref. no.	Colour	Water connection	Capacity	MOQ	Pieces / unit			€
222000	black	G 1/2"	1,5 L	2 pieces	2 / box	1/2	96	

Ref. no.	Description	Material	MOQ	Pieces / unit		€
22202	Valve	brass			1/10/400	
22202/1	Valve	brass	1 blister pack	1 / blister pack	1	
22210	mounting plate	metal			1/100	
221970	Guard Size 1	metal hot-dip galvanised			1/4	

Float Bowl S522

- low-priced float bowl made of polypropylene • with outlet plug for easy cleaning

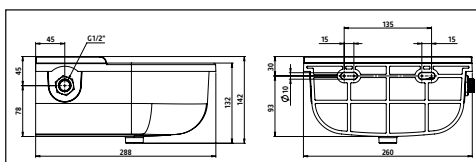

Technical data	22522
Dimensions (W x D x H)	25,5 x 29 x 14,5 cm
Connection option	from left or right



22523



Ref. no.	Colour	Water connection	Capacity			€
22522	green	G 1/2"	3 L	1/9	189	

Ref. no.	Description		€
22523	Floating valve	1/100	
22524	Drain Plug	1/100	

Float Bowl S190

- 1/2" connection for high pressure float valve (22192) • float cover made of stainless steel
- Supplies with float valve • Material: Grey Cast Iron powder-coated

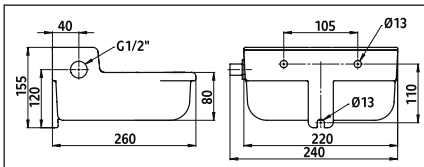

Technical data	22190
Dimensions (W x D x H)	22 x 26 x 15,5 cm
Flow rate	5 L/min at 3 bar
Weight	6 kg



Ref. no.	Colour	Water connection	Capacity			€
22190	green	G 1/2"	2 L	1	72	



Ref. no.	Description		€
22192	Floating valve High pressure	1/50	

Float Bowl S195

- drinking bowl made of gray cast iron, black enamelled
- Supplied with float valve

enamelled

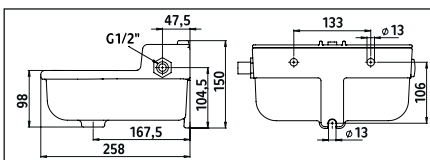

Technical data	22195
Dimensions (W x D x H)	25,8 x 15 cm
Connection option	from left or right
Flow rate	6,5 L/min at 3 bar



Ref. no.	Colour	Water connection	Capacity			€
22195	black	G 1/2"	3 L	1	60	



Ref. no.	Description	Material		€
22192	Floating valve High pressure		1/50	
22190	Guard Size 1	metal hot-dip galvanised	1/4	

Float Bowl S1090

• sturdy hot-dip galvanised float bowl • with efficient float valve • folding, self-locking valve cover

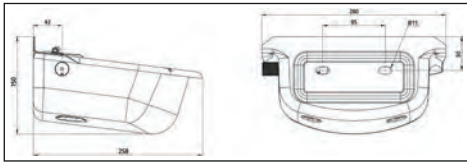

Technical data	221090
Dimensions (W x D x H)	28 x 26 x 13 cm
Connection option	from left or right
Flow rate	6,5 L/min at 3 bar

Ref. no.	Water connection	Capacity			€
221090	G 1/2"	2,5 L	1	120	

Ref. no.	Description		€
22192	Floating valve High pressure	1/50	



Float Bowl Biglac 25

• 17.5 cm deep trough made from high-strength polyethylene with inner edge to limit waste when slurping • with constant water level • Drain at the base • the float valve is not accessible to the animals and maintains a pressure of 9 bar • galvanised mounting plate • Connection with hose made from woven stainless steel, above or below, right or left, 1/2" inner thread • suitable for 15 large cattle • for wall and pipe mounting • Material: polyethylene

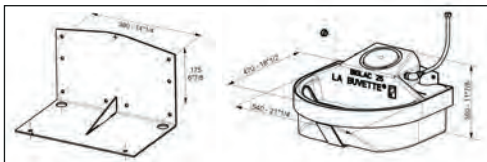

Technical data	22349
Connection option	from left, right, above or below
Flow rate	34 L/min at 4 bar

Ref. no.	Colour	Water connection	Capacity			€
22349	green	1/2" IG	25 L	1	16	



Feed Trough Long with float valve

Simple water supply for your animals without any installation work. Connect the hose - and that's it!

• float valve can be used on both sides of the trough • pipe piece and cover made from stainless steel • inc. click coupling for garden hose • for hanging • Material: Plastic



Ref. no.	Colour	Water connection	Capacity		€
223111	green	1/2"	42 L	1	

Ref. no.	Description		€
223113	Floating valve	1/10	

Technical data	
Connection option	via bracket feed

NEW

Water trough

- sturdy special material, extremely break-resistant and keeps its shape • UV and frost resistant • carefully thought-out design • stable internal wall curving inwards • oval shape allows easy loading into a small transporter • large outlet for rapid drainage (outlet item no. 16601 included) • water connection and float valve protected from animals • easy cleaning thanks to smooth surfaces and rounded edges - no inaccessible areas • stackable • Floor anchoring optionally available (accessories not included in the scope of delivery) • suitable for float valve 220P (41 l/min at 3 bar) and XtraFlo (250 l/min at 3 bar) • Float valve not included!



223624

223623



TV



Extra-reinforced inner rim and optimised float position for better water level regulation

Ref. no.	Colour	Capacity	Length	Width	Height			€	
223623	green	550 L	150 cm	115 cm	58 cm	1	6		
223624	green	1000 L	235 cm	125 cm	58 cm	1	6		

Ref. no.	Description		€
223440	Floating valve XtraFlo Top Entry	1/10/20	
223441	Floating valve 220P	1	
16601	Outlet for footbath / water trough	1/100	
223629	Ground anchor	1/10	

Water trough

- stackable • stable and inexpensive water troughs for outdoor use • with edge for optimal stability • a Suspended Float Valve 222905 can be retrofitted • lightweight and simple to set up • Material: Plastic UV-stabilised



223517

223518

Ref. no.	Description	Colour	Length	Width	Height	Capacity			€	
223518	without drain plug	dark green	102 cm	72 cm	38 cm	150 L	1	45		
223517	with drain plug	dark green	130 cm	81 cm	63 cm	380 L	1	35		

Ref. no.	Description	Material		€
222905	Immersion Float Valve	stainless steel	1/50	
16601	Outlet for footbath / water trough		1/100	

Drinking bowl for low pressure

Float Bowl SN190

for low pressure

- powder-coated grey cast iron bowl • Bowl volume: 2 litres • float cover made of stainless steel
- G 1/2" connection to low pressure float valve (22182) • Supplied with float valve
- for wall mounting

Technical data		22215	
Dimensions (W x D x H)	24 x 26 x 15,5 cm		
Connection option	from left or right		
Flow rate	4 L/min at 0,5 bar, 6 L/min at 3 bar		
Weight	6 kg		

Ref. no.	Colour			€
22215	green	1	72	

Ref. no.	Description		€
22182	Floating valve Low pressure	1/100	

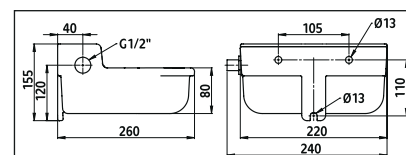



Water Bowl KN50

for low pressure

- water bowl made from high-quality plastic • with low-pressure valve • lockable tongue (separate accessory) • fastening clip and stabilisation plate are not included in the scope of delivery • for wall and pipe mounting

Technical data		225035	
Dimensions (W x D x H)	21 x 30,2 x 17 cm		
Connection option	from above or below		
Flow rate	7,2 L/min at 0,5 bar, 10,8 L/min at 0,75 bar		
Weight	0,95 kg		

Ref. no.	Colour	Water connection	Capacity			€
225035	green	G 1/2" / G 3/4"	2,2 L	1	120	

Ref. no.	Description	Material		€
22501	Mounting Bracket with stabilising plates in pairs	metal	1/25	
221970	Guard Size 1	metal hot-dip galvanised	1/4	
225034	Nose Paddle	Plastic	1/20	
223437	Valve Low pressure	Plastic	1/100/400	



22501



223437

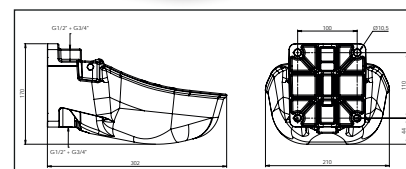

Water Bowl for pasture attachments

- drinking trough made of corrosion-free cast aluminium • suitable for all water containers • complete with gasket (221753) • complete with low pressure valve

Technical data		22175	
Dimensions (W x D x H)	23,5 x 28,7 cm		
Flow rate	10 L/min at 0,2 bar		

Ref. no.			€
22175	1	90	

Ref. no.	Description		€
22176	Valve Low pressure	1/50/500	
221753	Box Seal 8-edged	1/300	



22176

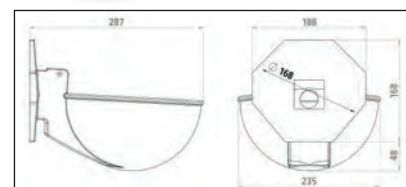

Drinking bowl for low pressure

Water Bowl N20

- solid, enamelled grey cast body with particularly large, deep bowl
- with low-pressure valve
- complete with flange seal
- Adapter plate for direct connection to pasture barrels
- Adapter plate not included; please order separately
- for wall and pipe mounting
- Material: Grey Cast Iron enamelled

Technical data	222030
Dimensions (W x D x H)	23,5 x 29 x 15,8 cm
Connection option	from above or below
Flow rate	10 L/min at 0,2 bar



Ref. no.	Colour	Water connection	Capacity			€
222030	black	G 1/2"	2 L	1	55	

Ref. no.	Description		€
221757	Adapter plate for pasture attachments	1/5	
221758	Box Seal for adapter plate	1/100	
22176	Valve Low pressure	1/50/500	

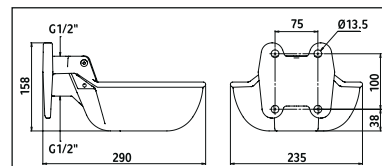

Water Bowl KN50 for pasture attachments

- water bowl made from high-quality plastic
- incl. adapter plate for direct connection to pasture barrels
- complete with low pressure valve
- complete with flange seal
- for attaching to barrels

Technical data	221755
Dimensions (W x D x H)	21 x 30,2 x 17 cm

Ref. no.	Description	Colour	Capacity		€
221755	incl. adapter plate	green	2,2 L	1	

Ref. no.	Description	Material		€
221757	Adapter plate for pasture attachments		1/5	
221758	Box Seal for adapter plate		1/100	
225034	Nose Paddle	Plastic	1/20	
223437	Valve Low pressure	Plastic	1/100/400	

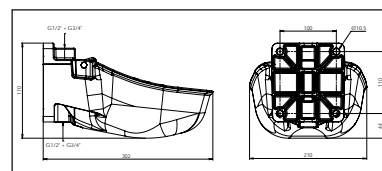

Double Float Drinking Bowl S60 for pasture attachments

- water bowl made from high-quality plastic
- for up to 40 large cows
- complete assembly for easy mounting to pasture barrel
- with inner lip to avoid water waste
- with 2 outlet plugs for easy cleaning
- larger outlet (16601) can be retrofitted
- valve on the top for rapid access to the valve
- with drain plug

complete assembly for easy mounting to pasture barrel

Technical data	223619
Dimensions (W x D x H)	90 x 45 x 35 cm
Connection option	from above, below or behind
Flow rate	24 L/min at 1 bar
Weight	15 kg

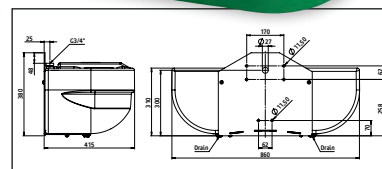

Ref. no.	Description	Colour	Water connection	Capacity			€
223619	for pasture attachments	green	G 3/4"	58 L	1	8	



Ref. no.	Description		€
223441	Floating valve 220P	1	
16601	Outlet for footbath / water trough	1/100	



Drinking bowl for low pressure

Connection Set for IBC containers

• for connecting a drinking bowl to an IBC container • flexible reinforced hose 70 cm • incl. connecting accessories (see scope of delivery)

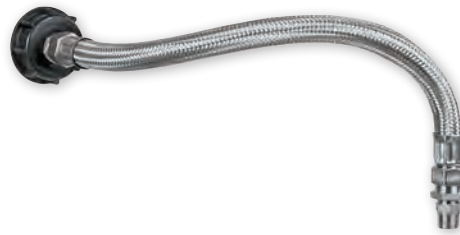
Included in delivery: 1 x reinforced hose 70 cm (2 x 3/4" IT connection), 1 x adapter for IBC container incl. gasket (S60 x 6 on 3/4" OT), 1 x straight reducer 3/4" OT to 1/2" IT, 1 x double nipple 1/2"OT to 1/2"OT, 1 x double nipple 3/4"OT x 3/4" OT



Ref. no.	Description			€
221980	Connection Set for IBC containers	1/20	240	

Installation plate for IBC containers

• installation plate for securing drinking bowls to IBC container • suitable for drinking bowls with low-pressure valve



Which drinkers will fit?

Item no. 22215	Float drinking bowl SN190
Item no. 225035	Drinking bowl KN50
Item no. 222030	Drinking bowl N20

Ref. no.	Length	Width		€
221981	275 mm	175 mm	1/10	



GEA



Water Troughs

Valve trough drinker

- drinkers made from rust-resistant stainless steel
- straightforward cleaning of the trough drinkers by lifting the pressure flap
- suitable for connection to the circulation pipe, single-sided connection also possible
- additional heater optionally available
- attachment is externally on the underside of the drinking trough
- for wall and pipe mounting

2 heaters are necessary for item no. 221131

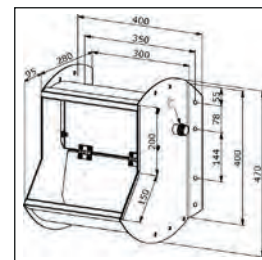

Made in Germany



221131

221130

Art. 221132: to be operated with transformer (not included in scope of delivery!)

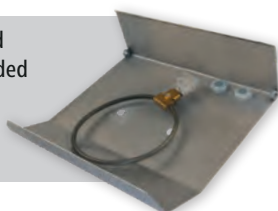

Technical data	221130	221131
Dimensions (W x D x H)	300 x 375 x 400 mm	300 x 760 x 400 mm
Connection option	from left or right	from left or right

Ref. no.	Description	Water connection	Capacity			€
221130	simply	G 3/4"	5 L	1	12	
221131	double	G 3/4"	10 L	1	9	

Ref. no.	Description		€
221132	Additional heater	1	
221133	Valve for valve trough drinker	1	

Stainless Steel Water Trough

• Drinking trough made from rust-resistant stainless steel • Galvanised wall bracket and floor stand • large drain and inclined trough base ensure rapid draining of the water and self-cleaning of the trough • expansion sealing plugs for quick opening and closing of the drain • drain connection so suit KG pipe DN 100 • with 3/4" high performance float valve • easy to open valve cover • Frost-free down to -15 °C: integrated electric heating 200 W (item no. 221142, 221143, 221152, 221153) or can be retrofitted (item no. 221094), operation with transformer (not included) • valve XtraFlo with 250 l/min at 3 bar optionally available



with heating frost-protected down to about -15°

Technical data:	Water trough 100 cm (inside)	Water trough 190 cm (inside)
Outer dimensions with wall panel (L x W x H)	117 x 60 x 64 cm	207 x 60 x 64 cm
Outer dimensions with floor stand (L x W x H)	122 x 58 x 102 cm	212 x 58 x 102 cm
Water connection	From left or right	From left or right
Water flow rate	54 l/min at 5 bar, 41 l/min at 3 bar	54 l/min at 5 bar, 41 l/min at 3 bar

Ref. no.	Description	Interior length	Capacity		€	
221140	with floor stand	100 cm	50 L	1		
221141	with wall bracket	100 cm	50 L	1		
221150	with floor stand	190 cm	95 L	1		
221151	with wall bracket	190 cm	95 L	1		
221142	heatable, with base frame	100 cm	50 L	1		
221143	heatable, with wall bracket	100 cm	50 L	1		
221152	heatable, with base frame	190 cm	95 L	1		
221153	heatable, with wall bracket	190 cm	95 L	1		

Ref. no.	Description	suitable for		€
221145	Floor Stand for stainless steel water trough	221140, 221150	1	
221146	Wall Bracket for stainless steel water trough	221141, 221151	1	
223441	Floating valve 220P		1	
223440	Floating valve XtraFlo Top Entry		1/10/20	
221094	Additional / replacement heating 200 W		1	
221144	Sealing Plug for stainless steel water trough		1/20/80	

Tip trough

with tipping mechanism

Made in Germany



- flat drinking trough made from rust-resistant stainless steel
- Galvanised wall bracket and floor stand
- fast cleaning thanks to tilting mechanism
- float valve with 1/2" connection
- can be used at up to 6 bar max. without pressure reducer

Versions with heating:

- Heating under the float valve cover
- to be operated with transformer (not included)



with heating frost-protected down to about -15°



Tip: An additional 100 W or 200 W heater can be retrofitted. For all tilting drinkers (including those made after 2010), only items 221048 and 221047 are suitable.



Technical data:	Tip trough 30 l	Tip trough 50 l	Tip trough 70 l
Inner dimensions of tip trough (L x W x H)	89 x 40 x 17 cm	139 x 40 x 17 cm	188 x 40 x 17 cm
Outer dimensions with wall panel (L x W x H)	103 x 50 x 43 cm	153 x 50 x 43 cm	203 x 50 x 43 cm
Outer dimensions with floor stand (L x W x H)	103 x 45 x 87.5 cm	153 x 45 x 87.5 cm	203 x 45 x 87.5 cm
Water connection	from left or right	from left or right	from left or right
Water flow rate	30 l/min at 3 bar	30 l/min at 3 bar	30 l/min at 3 bar

Ref. no.	Description	Capacity			€	
221033	with wall bracket	30 L	1	8		
221032	with floor stand	30 L	1	8		
221020	with wall bracket	50 L	1	8		
221021	with floor stand	50 L	1	8		
221022	with wall bracket	70 L	1	8		
221023	with floor stand	70 L	1	8		
221019	heatable, with wall bracket	30 L	1	8		
221018	heatable, with base frame	30 L	1	8		
221024	heatable, with wall bracket	50 L	1	8		
221025	heatable, with base frame	50 L	1	8		
221026	heatable, with wall bracket	70 L	1	8		
221027	heatable, with base frame	70 L	1	8		

Ref. no.	Description		€
221056	Heating 100 W, 24 V - for Tip Troughs from 2010	1	
221057	Heating 200 W, 24 V - for Tip Troughs from 2010	1	
221048	Heating 100 W, 24 V - for Tip Troughs up to 2009	1	
221047	Heating 200 W, 24 V - for Tip Troughs up to 2009	1	
221038	Floating valve	1/100	

Universal and boiler brush

- Polypropylene bristles, medium hardness
- Bristle thickness: 0,3 mm

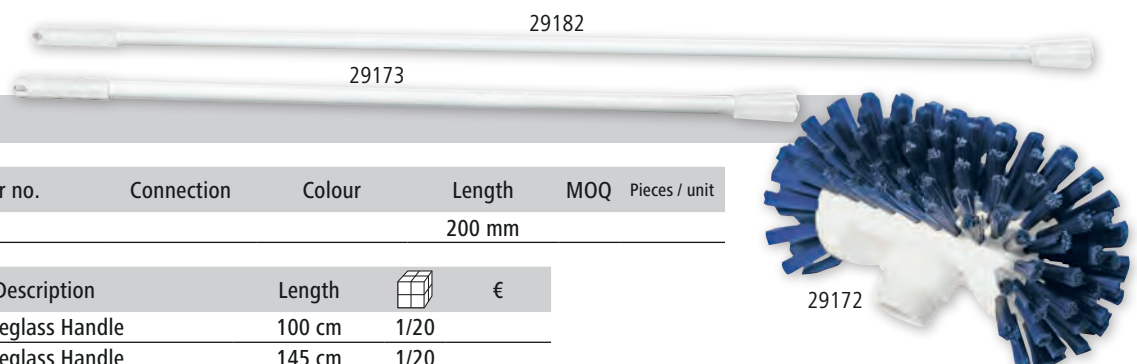

up to 80 °C heat-resistant

Ref. no.	Customer no.	Connection	Colour	Length	MOQ	Pieces / unit
29172				200 mm		

Ref. no.	Description	Length		€
29173	Fibreglass Handle	100 cm	1/20	
29182	Fibreglass Handle	145 cm	1/20	

Heated 24 V drinking bowls – how do they work?

Heating drinking water using drinking bowls is so easy! You only need at least one heated drinking bowl, a thermostat and a transformer (as 24 V operation). Which transformer for how many bowls? Simple! If you only want to use one drinking bowl with 80 W of power, a 100 VA transformer will suffice.

If you also want to connect a 24 V heating cable, simply add the power consumption (= wattage) of the cable and this gives you the minimum power required for the transformer. Do not measure the transformer's power too precisely, so you will have a buffer for extensions.

When choosing a transformer, ensure that you factor in the power loss caused by the supply cables. You will find a sample calculation and a table containing power loss values in this catalogue.

Connection diagram

1. Mains connection 230 V, separately fused
2. Water connection, spur line or circulation system possible
3. Frost-protection thermostat 230 V (222794)
4. Junction box, protection class at least IP54
5. Transformer 230 V AC => 24 V AC, 100 W (222796), 200 W (222797), 300 W (222626), 400 W (222798)
6. Junction box, protection class at least IP54
7. 24 V supply cable for further heated drinking bowls or heating cables
8. 24 V supply cable for connecting to the drinking bowl
9. 24 V frost-protection heating line (22358, 223581) (if not connected to a circulating heat system)
10. Protective plate for the bite area (221975)
11. Pipe insulation
12. Heated drinking bowl (e.g. 222010)

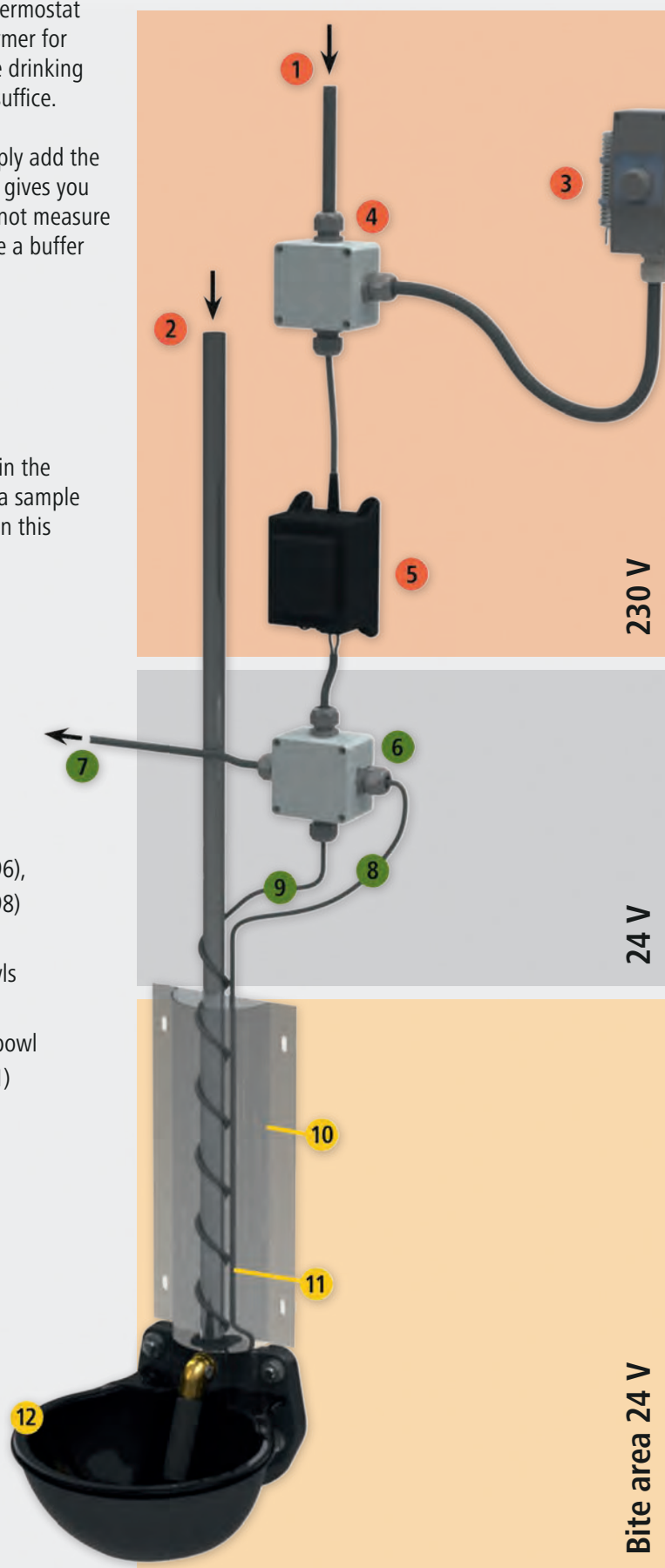

Frost Protection Drinkers



Water Bowl H10 heatable

- drinking bowl made of gray cast iron, black enamelled
- Grey cast iron bottom tray, black power-coated finish
- water flow rate can be regulated on the pipe valve
- new heating concept with valve heating to keep clear of frost
- easy to install bowl, no need to remove the valve for installation
- power supply via transformer at least 100 W (not supplied)
- suitable for circulating heating systems
- simple electrical connection through the terminal box on the outside
- for wall and pipe mounting

frost-protected down to approx. -20 °C



Upper shell
Heating element
Lower shell

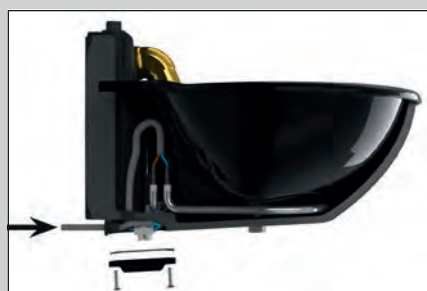

24 V pin can be connected to the 24 V conduit without disassembling the drinking bowl



222019
Ø 1 - 3"

80 W or 50 W

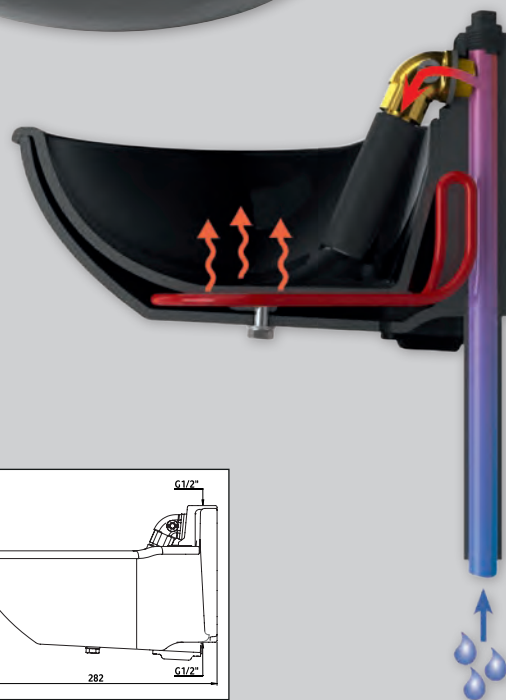
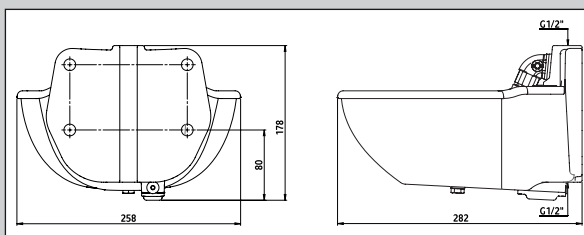

Technical data

Dimensions (W x D x H)	25,8 x 28,2 x 17,8 cm
Connection option	from above or below
Flow rate	8 L/min at 3 bar
Weight	11,5 kg

Ref. no.	Colour	Heating output	Voltage	Water connection	Capacity			€
222010	black	80 W	24 V	G 1/2"	1,6 L	1	48	
222005	black	50 W	24 V	G 1/2"	1,6 L	1	48	

Ref. no.	Description	Material	Length	Width	Height		€
222019	Pipe Mounting Bracket in pairs	metal powder-coated				1	
221971	Guard Size 2	metal hot-dip galvanised				1/4	
221975	Gnaw protection for pipes	Sheet metal galvanic zinc-plated	100 cm	13,2 cm	8 cm	1	

Float Bowl SH30 heatable



• drinking bowl made from high-quality plastic with integrated heating cable • integrated frost protection thermostat (switch-on temperature approx. +5 °C, switch-off temperature approx. +13 °C) • heating cable easy to replace • suitable for circulating heating systems • valve cover with snap hook for rapid access • with valve type 22182 also suitable for connection to low pressure • with outlet plug for easy cleaning • for wall and pipe mounting

- 222062 + 222063: with heating cable (approx. 31 W) for heating the drinking bowl and valve
- 222064 + 222065: with heating cable (approx. 73 W) for heating the drinking bowl, valve and up to 2 metres of pipeline (auxiliary pipe heating).
- a transformer is required for the 24 V version (not included)



frost-protected down to approx. -15 °C

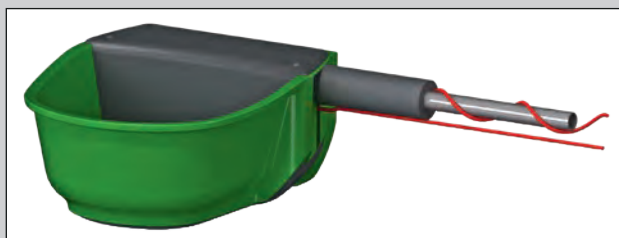

with integrated pipe heating



External frost-protection thermostat

Drain plug

The cover on the underside of the bowl prevents the heat given off by the heating cable from escaping.

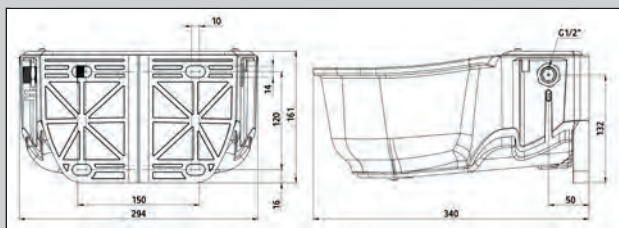

4 versions	with auxiliary pipe heating, 73 W	without auxiliary pipe heating, 31 W
24 V	222065	222063
230 V	222064	222062

Technical data

Connection option	from left or right
Flow rate	6 L/min at 3 bar
Weight	2,7 kg



Ref. no.	Colour	Pipe Heating	Heating output	Voltage	Water connection	Capacity			€
222062	green	without pipe heating	31 W	230 V	G 1/2"	5 L	1	42	
222063	green	without pipe heating	31 W	24 V	G 1/2"	5 L	1	42	
222064	green	with auxiliary pipe heating	73 W	230 V	G 1/2"	5 L	1	42	
222065	green	with auxiliary pipe heating	73 W	24 V	G 1/2"	5 L	1	42	

Ref. no.	Description	Material		€
222019	Pipe Mounting Bracket in pairs	metal powder-coated	1	
22192	Floating valve High pressure		1/50	
22182	Floating valve Low pressure		1/100	
221970	Guard Size 1	metal hot-dip galvanised	1/4	

Frost Protection Heating 24 V

• for heating the spur line of waterers • a 24 V transformer is required for operation • IPX7



Ref. no.	Heating output	Length			€
22358	15 W	1,5 m	1/60	720	
223581	30 W	3 m	1/60	720	

Transformer for pool heating

• transforms the voltage from 230 volts to 24 volts • can be used for all frost-free waterers • Short circuit and overload protection through easily replaceable automotive fuse in the output circuit • the transformers are also secured against overheating thanks to an integrated temperature limiter (automatic reset after cool-down) • IP 65 (transformer) / IP 20 (connection) • Produced using vacuum casting: the best possible protection against moisture, mechanical and electronic loads

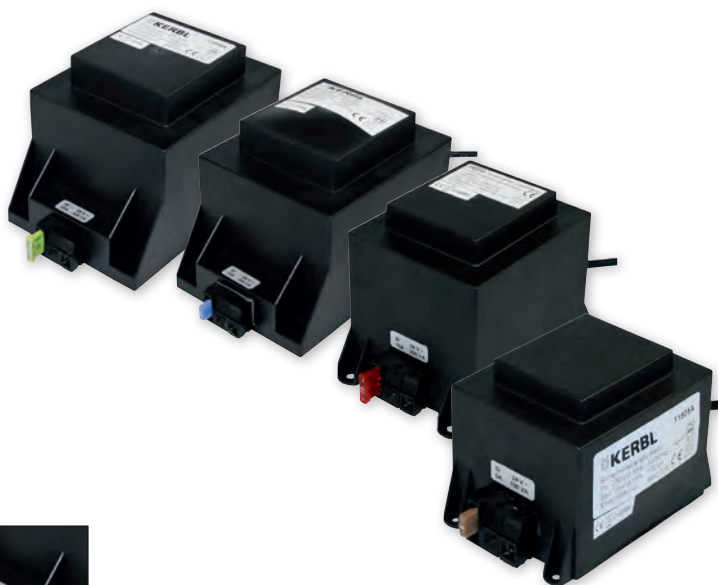

Ref. no.	Thickness		€
222796	100 VA	1	
222797	200 VA	1	
222626	300 VA	1	
222798	400 VA	1	



Conventional car microfuses for safe operation of the installation

Which transformer should be used?

If you want to operate a water bowl with 80 watts of power (supplied), then a 100-watt transformer will suffice (item no. 222796). If you also want to connect a 24 V heating cable, simply add the current consumption (= wattage) of the cable. When selecting the transformer, plan for a power reserve of 15 % (factor 1.15).

Calculation example for transformer:

2 x drinking bowls with 100 W power consumption	= 200 W
1 x frost-protection heating line 24 V each with 30 W	= 30 W
1 x frost-protection heating line 24 V each with 15 W	= 15 W
Total consumer power	= 245 W
Buffer (flat rate of 15 %) 245 W x 1.15	= 282 W

The transformer of choice has an output of 300 W.

Which cable should I use?

If the 24 V supply has to cover a larger distance between the transformer and the heater, please pay attention to the cable cross-section, to prevent the risk of drops in voltages along the cable's route.

Calculation to ascertain the minimum cable cross-section: **Power x cable length: 3200 W/m**

In the above example, the result for a distance of 25 metres from the transformer to the heater is as follows: **(282 W x 25 m: 3200 W/m) mm² = 2.2 mm²**

In this case, a cable with a cross-section of 2.5 mm² must be used.

Frost Protection Heating with thermostat

- keeps your water line frost-free to -45 °C • integrated frost protection thermostat (switch-on temperature approx. +5 °C, switch-off temperature approx. +13 °C) • not suitable for heating pipes • do not insulate the thermostat when adding insulation • Protect the area animals could chew on with a bite protector
- VDE tested heating cable • 230 V • IPX7

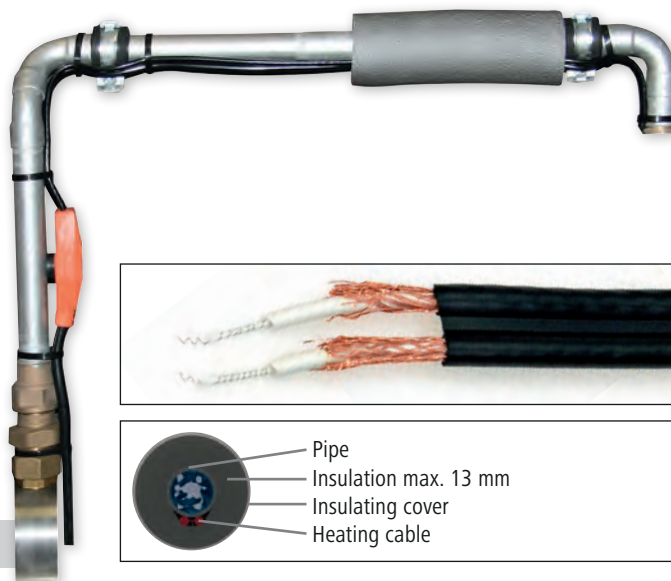

Do not mount in animal feed area unprotected - use only 24-volt heating cable. Do not shorten the heating cable!

frost-protected down to max. -45 °C

Ref. no.	Heating output	Length	Plug type	MOQ	Pieces / unit			€
223582	16 W	1 m	with safety plug	1 blister pack	1 / blister pack	1/16	192	
223585	32 W	2 m	with safety plug	1 blister pack	1 / blister pack	1/16	192	
223586	64 W	4 m	with safety plug	1 blister pack	1 / blister pack	1/16	192	
223587	128 W	8 m	with safety plug	1 blister pack	1 / blister pack	1/16	192	
223588	192 W	12 m	with safety plug	1 blister pack	1 / blister pack	1/16	192	
223590	224 W	14 m	with safety plug	1 blister pack	1 / blister pack	1/16	192	
223589	288 W	18 m	with safety plug	1 blister pack	1 / blister pack	1/10	100	
223591	384 W	24 m	with safety plug	1 blister pack	1 / blister pack	1/10	100	
223592	592 W	37 m	with safety plug	1 blister pack	1 / blister pack	1/5	75	
223593	784 W	49 m	with safety plug	1 blister pack	1 / blister pack	1/5	60	

Frost-protection heating lines

- prevent water pipes from freezing
- Thermostat in the heating cable switches the cable on automatically

What to remember about 230 V heating cables:

- Always attach the heating cable to the underside of the pipe
- the water pipe must be earthed
- 230 V heating cables are ready to connect and should be connected to a power supply with a 30 mA residual current circuit breaker
- heating cables must not be shortened and should therefore be ordered in the correct length
- Excess length can be wound around the pipe (note that a winding distance of at least 15 mm must be maintained between coils)
- Do not bend heating cables and note the maximum bending radius of approx. 35 mm
- heating cables can be secured to the pipe with insulating tape or aluminium tape (222809)
- if using plastic pipes, wrap aluminium tape (222809) around the pipe

- before routing the heating cable
- if using plastic pipes, please pay attention to the separate, specific assembly instructions
- insulate the pipe and heating cable with insulation of max. 13 mm
- attach the heating cable thermostat to the coldest part of the pipe
- insulate the thermostat only moderately
- do not use 230 V heating cables in the bite area of animals
- installation must be carried out by a qualified professional in accordance with VDE0100

Pipe	Ø 15 mm	Ø 22 mm ½"	Ø 28 mm ¾"	Ø 35 mm 1"	Ø 42 mm 1 ¼"	Ø 48 mm 1 ½"	Ø 60 mm 2"	Ø 76 mm 2 ½"
With insulation (max. 13 mm) frost-resistant to	- 45 °C	- 45 °C	- 40 °C	- 40 °C	- 35 °C	- 30 °C	- 25 °C	- 20 °C

Circulation Pump AquaLine

Circulation pump with integrated heater

AquaLine is the ideal solution for watering systems with a loop length of max. 250 m (with 3/4" pipeline) for providing animals with tempered water. The constant movement of the water and the switchable heating provide double anti-freezing protection.

- AquaLine Classic and AquaLine Digital:
- winter and summer operation (with/without heating)
- automatic control of the set water temperature
- automatic safety shut-off in case of overheating
- separate display of the operating status of the pump and heater via indicator lights on the control unit
- venting valve on the heating body
- high-quality insulated electronics housing made from polyamide to avoid the build-up of condensation
- easy installation for a heating or plumbing specialist
- low space requirement due to compact design
- low-maintenance thanks to high-quality materials
- mounting kit included for wall mounting
- 2-year warranty
- Water connection: 3/4" from below
- Voltage: 230 V

AquaLine Digital:

- PTC probe with digital control thermostat
- precise setting of the target temperature via the display or control box (10 °C to 25 °C)
- indication of the measured temperature on the display
- acoustic and visual signal when the temperature falls below or exceeds the limit temperatures (5 °C / 30 °C)
- flow monitoring with an acoustic and visual signal as well as an automatic heater interrupter when the flow rate falls below the min. value of 6 l/min



AquaLine Classic



AquaLine Digital

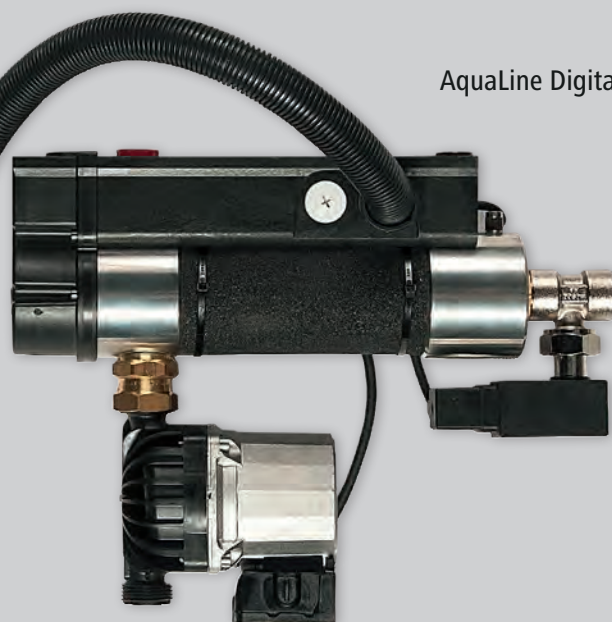

Ref. no.	Description	Length	Width	Height	Power		€
22331	Classic	410 mm	110 mm	160 mm	3.000 W	1	
223073	Digital	410 mm	110 mm	160 mm	3.000 W	1	

Connection diagram

The entire ring line must be adequately insulated in the frost-risk area. In the bite area, the insulation and additional electrical cables must be protected against biting.

Frost-risk area

Frost-proof area

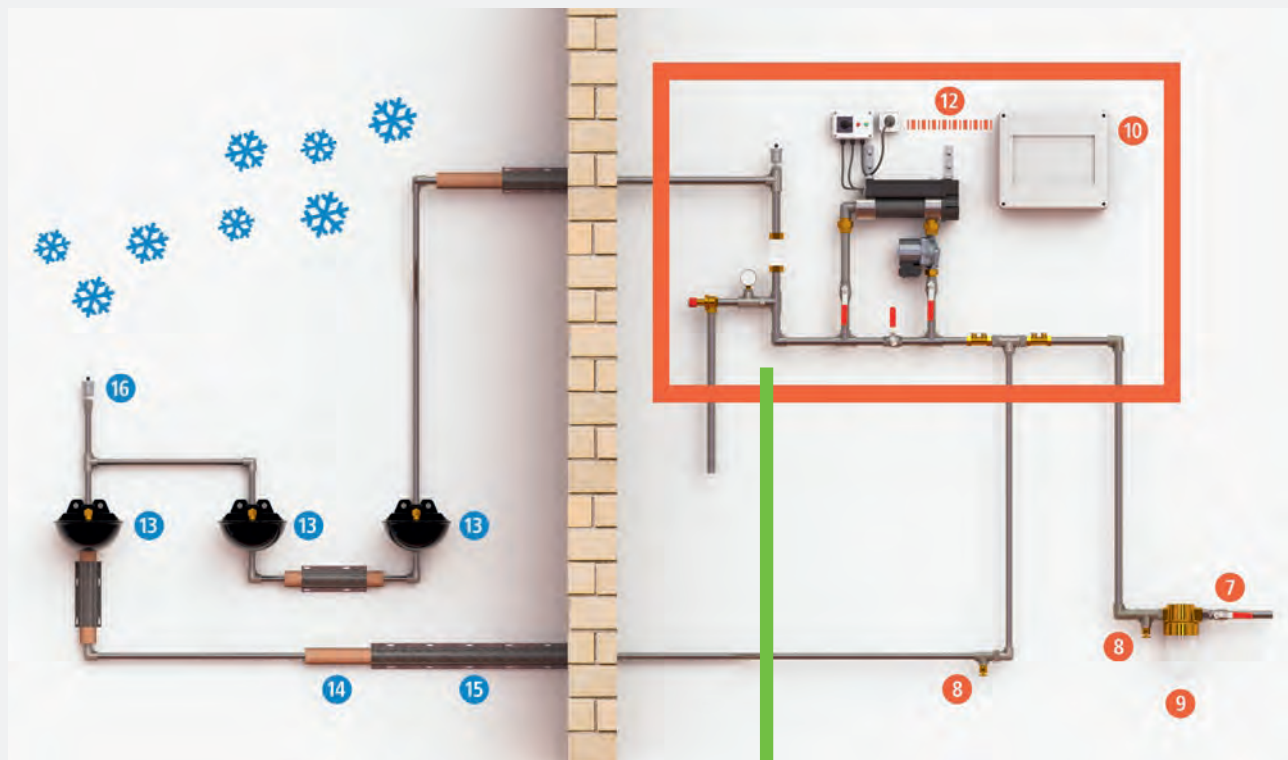

1. Aqualine (22331, 223073)
2. Non-return ball valve
3. Safety overpressure valve
4. Automatic bleed valve
5. Overpressure manometer
6. Flow rate display
7. Ball valve
8. Outlet valve
9. Water filter
10. Junction box with residual current circuit breaker for Aqualine 30 mA
11. On/Off switch for Aqualine
12. Supply cable to 16 A socket for Aqualine
13. Drinking bowl, suitable for circulation systems (e.g. 221851)
14. Insulation material
15. Bite protection for insulation material and cables
16. Spur line

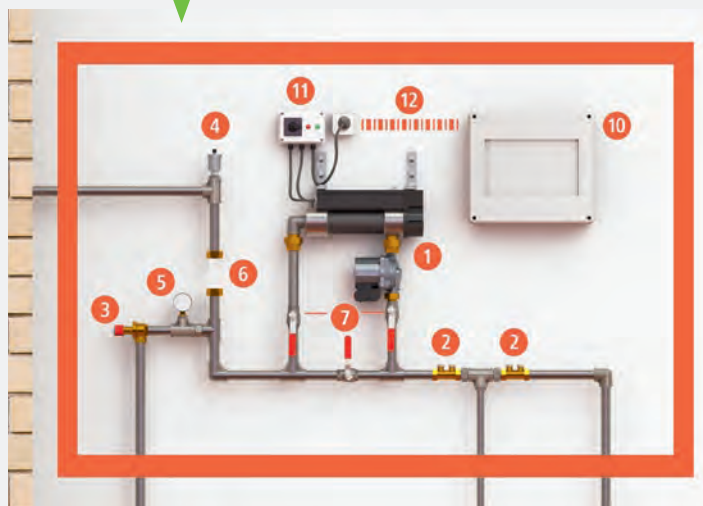

Installation with the BYPASS system – the ball cocks allow the pump to be separated quickly and easily from the ring circuit. The two supplied self-sealing screws allow the pump to be quickly and easily removed once it has been disconnected.

With a 3/4" pipe diameter, up to 250 m of ring cable are possible. Max. pumping height: 6 m.

The following accessories for producing the pipework are included: 1 x safety overpressure valve, 3 automatic bleed valves and 1 x non-return valve. The pipework must be built and dismantled by a suitably qualified professional.

Frost Protection Drinkers

Thermal Trough

- high insulation through double wall with a thermal foam filling • stays frost-free thanks to flowing water • constant water temperature (approx. 3 to 5 °C in winter, approx. 10 to 12 °C in summer), pleasant for animals all year round • fast emptying and rinsing thanks to large drain with ø 100 mm • enclosed housing prevents soiling and ensures optimum water hygiene • no mains supply needed
- incl. base seals, spare gaskets for float valve and drain plug, flexible stainless steel hose, pipe insulation, floor anchor • for floor mounting • with drain plug 100 mm • Material: Plastic

Duo:

- 20 animals recommended minimum stocking
- for feeding water to up to 30 animals

Uno:

- 10 animals recommended minimum stocking
- for feeding water to up to 15 animals



frost-protected down to approx. -30 °C

Float valve with water flow up to 35 L/min

Size of outlet openings



Technical data	223600	223610
Dimensions (W x D x H)	108,5 x 70 x 52,5 cm	60 x 70 x 52,5 cm
Connection option	from below	from below

Ref. no.	Description	Water connection	Capacity			€
223600	Duo	G 1/2"	100 L	1	4	
223610	Uno	G 1/2"	40 L	1	8	

Ref. no.	Description		€
223601	Floating valve	1/10	

Connection diagram

1. Pipe insulation
2. Ground insulating seal
3. braided stainless steel hose
4. double sealing strips
5. Float valve
6. Ball
7. PU hard foam insulation
8. large fast-acting drain
9. Concrete step plinth (at least 15 cm thick)
10. frost-resistant depth (0.8 – 2.0 m, depending on region)
11. Water inlet, 1/2"
12. Open to the ground, so that ground heat can rise
13. Pipe: Minimum diameter 30 cm

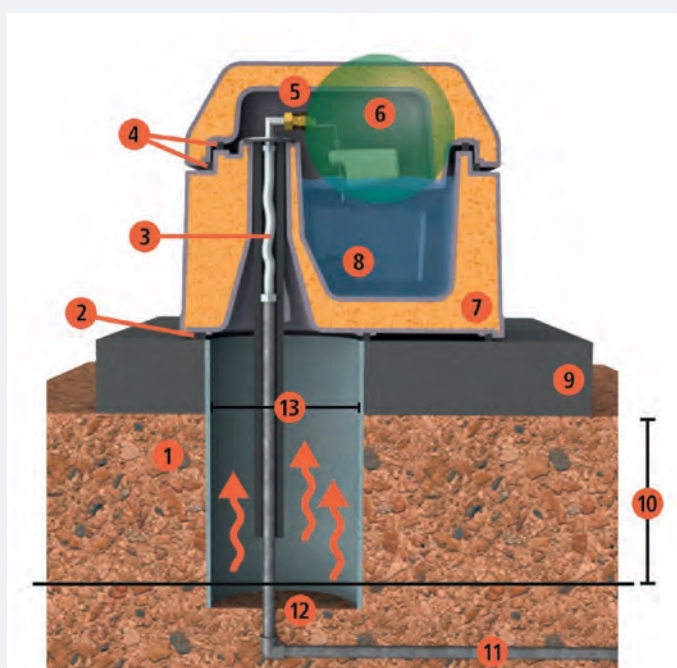

Animal Scales

The PS animal scale represents simple, easy and precise weighing. It boasts extremely easy installation and operation and is also virtually maintenance-free.

- Battery and power pack included
- includes operating instructions

Platform PS 1000/PS 2000:

- capacity: 500 kg (PS 1000) or 1,000 kg (PS 2000)
- robust, powder-coated steel construction with profiled non-slip surface, access ramps on both sides and height-adjustable feet to compensate uneven surfaces
- portable thanks to low weight and integrated carry handles

Platform PS 3000:

- capacity: 1,500 kg
- extremely robust, powder-coated steel construction with large surface, designed for large animals
- the integrated anti-slip rubber mat offers exceptionally good grip

Display unit:

- LCD (PS 1000/2000) or LED (PS 3000) with digital display
- 5 m connecting cable to platform
- 230 V mains or battery operation (power pack and batteries included)
- RS232 interface (full duplex) for the connection of printers, external displays, etc. (RS232 cable included)
- automatic shut-off
- housing of stainless steel (PS 1000/2000) or high-quality ABS plastic (PS 3000)
- wall bracket included
- stand (height 1 m) optionally available

Functions:

- Hold (animal weighing function): The average weight measured in the first seconds after the animal walks onto the scale remains on the display until the next animal walks onto the platform. ideal for weight fluctuations when restless animals are being weighed
- Print: Send data via RS232 interface
- Units: Toggle display between kg and lb
- Tare: Tare function (display of net weight)



Technical data	291310	291311	291312
Display	LCD	LCD	LED
tare weight function	100 % of the weighing range	100 % of the weighing range	100 % of the weighing range
Overload capacity	150 %	150 %	150 %
Weighing platform	141,6 x 51,4 x 6,4 cm	149,8 x 76,2 x 6,4 cm	200 x 100 x 10 cm
Weight of weighing platform	34 kg	55 kg	135 kg
Weighing precision	+/- 0,5 kg	+/- 1 kg	+/- 1,5 kg
Weighing unit can be switched	kg / lb	kg / lb	kg / lb
Battery Operation	4 x 1.5 V - AAA (Micro) Alkaline	4 x 1.5 V - AAA (Micro) Alkaline	4 x 1.5 V - AAA (Micro) Alkaline

Ref. no.	Description	Scales readability (d)	Weighing range			€	
291310	PS 1000	200 g	500 kg	1	8		
291311	PS 2000	500 g	1.000 kg	1	6		
291312	PS 3000	500 g	1.500 kg	1	7		

Ref. no.	Description		€	
291314	Stand for display unit	1/5		

Animal Scales AniScale

This animal scale with cradle stand is ideal for weighing large animals. The animals can easily be put into the cage and held for the weighing procedure. The animal scale can be integrated into trap systems or races.

- The complete set consists of stand and scale set.
- To combine the animal scale with a trap system, please use the connector frame so as not to distort the weighing result.



The scale stand

- weighing platform with rubber mat
- animals can stand safely, noise-dampening
- extremely robust design
- hot-dip galvanised
- with 2 sliding doors at the front and rear
- 2 panels of 240 cm included
- easy to integrate in palisade trap systems or races

The weighing set

- robust scale beams are mounted below the cage
- handles on the scale beams for easy carrying and positioning
- display with handy carry handle
- with LED display
- with battery, operating time per charge approx. 30 hours
- charger included
- optional stand for display

Functions

- stabilisation function, determines the weight of moving animals
- tare function
- totalling possible



Technical data	291320
Display	LED
tare weight function	100 % of the weighing range
Overload capacity	110 %
Weight	380 kg
Weight of weighing platform	167 kg
Weighing precision	+/- 1,5 kg

Ref. no.	Description	Length	Width	Height	Scales readability (d)	Weighing range	€
291320	Complete Set	265,7 cm	88 cm	200 cm	500 g	1.500 kg	

Ref. no.	Description	Material	Length	Width	Height			€
291324	Weighing platform with weighing set (no panels or sliding door)					1		
291325	Scale Stand (with weighing platform, 2 panels and 2 sliding doors)	metal hot-dip galvanised	265,7 cm	88 cm	200 cm	1	2	
291321	Weighing platform single	metal hot-dip galvanised				1		
291322	Weighing Set (2 x scale beams with display)					1	2	
442620	Extension element Sliding door, single	metal hot-dip galvanised		85 cm	200 cm	1		
442591	Pasture Panel without gate	metal hot-dip galvanised	240 cm		170 cm	1	48	
442621	Extension element Connector frame for panels	metal hot-dip galvanised		85 cm	186 cm	1		
291323	Stand for weigh set display	metal				1		

Rain Gauge with counter

• easy installation on a round pile up to \varnothing 27 mm • Precipitation is easy to read: 1 scale bar = 1 mm = 1 L/m² • monthly rainfall is easy to total up using the adjustable counter. Simply turn the rotary ring by the respective additional rainfall amount • with printed measurement scale



Ref. no.	Colour	Material		€
291199	green	Plastic	1/16	

Feed Scoop



• Material: Plastic • with embossed measuring scale

Ref. no.	Colour	Capacity			€
29725	transparent	2 L	1/24	288	



Feed scoop with inverted handle

• ergonomic inverted handle • made of durable plastic with UV protection



Ref. no.	Colour	Capacity			€
29693	green	2000 g	1	320	



Feed Scoop

• break-proof plastic



Available in customer-specific composition.
Note the instructions at the end of the catalogue.

Ref. no.	Colour	Capacity			€
29692	dark green	500 g	1	800	
29738	green	2000 g	1	600	
29694	light green	2000 g	1/60	720	



Weigh Scoop



• for weighing concentrated feed

Ref. no.	Description	Material	Capacity			€
29758	angular	Aluminium	900 g	1/75	600	
29796	round	Aluminium	900 g	1/80	800	
29760	angular	Aluminium	1600 g	1/75	600	
29797	round	Aluminium	1600 g	1/50	400	
29761	angular	Aluminium	2500 g	1/50	400	
29798	round	Aluminium	2500 g	1/40	320	



Weigh Scoop Inverted Handle

• Handy • versatile application

Ref. no.	Material	Capacity			€
29762	Aluminium	1250 g	1/50	300	
29763	Aluminium	2000 g	1/40	240	



Multipurpose Grease Viscano

- can be used for plain bearings and roller bearings under normal loads
- can be used at low to high speeds, low and high temperatures, as a universal grease both for general machine lubrication and for demanding lubrication points
- guaranteed a good seal and durability in wet or dusty environments
- easy to move, even through long lubrication lines

Made in Germany



Operating temperature range: -30 °C to + 120 °C



Ref. no.	Contents			€
29866	400 g / Cartridge	1/12	1.008	



Large broom

- wooden back • suitable handle for handle holder Ø 24 mm: 2962
- suitable handle for handle holder Ø 27 mm: 2961 • with elastane bristles • with bolted handle holder



Ref. no.	Handle	Colour	Width	Ø handle holder			€
2943	without handle	red	40 cm	24 mm	1	250	
2944	without handle	red	50 cm	24 mm	1	200	
2945	without handle	red	60 cm	27 mm	1	150	
2946	without handle	red	80 cm	27 mm	1	100	
29461	without handle	red	100 cm	27 mm	1	80	

Large broom Kompakt

- wooden back • with elastane bristles • with handle halter
- matching handle: 2962



Ref. no.	Handle	Colour	Width	Ø handle holder			€
29473	without handle	red	40 cm	24 mm	1	250	
29441	without handle	red	50 cm	24 mm	1	200	
29477	without handle	red	60 cm	24 mm	1	150	

Large broom

- wooden back • Arenga Elaston bristles • with handle halter

29478: matching handle 2962

29481: matching handle 2961





Ref. no.	Handle	Colour	Width	Ø handle holder			€
29478	without handle	black / red	50 cm	24 mm	1/10	200	
29481	without handle	black / red	60 cm	28 mm	1/10	120	



Large broom with horsehair

- wooden back • for fine dust • extra fully stocked • with horsehair bristles
- with handle halter • matching handle: 2962





Ref. no.	Handle	Colour	Material	Width	Ø handle holder			€
29463	without handle	black	Wood	40 cm	24 mm	1/10	160	
29471	without handle	black	Wood	50 cm	24 mm	1/10	120	
29474	without handle	black	Wood	60 cm	24 mm	1/10	120	

Large broom with scraper edge

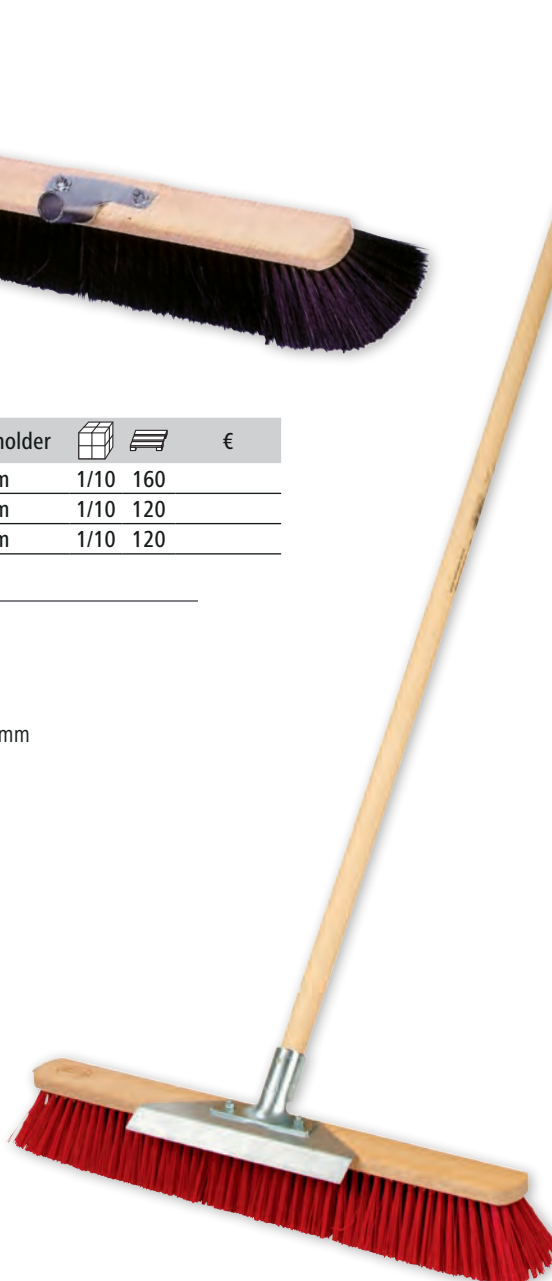

- ideal for removing ice, compacted snow, chewing gum, cigarettes, etc. • fully assembled with bolted handle holder • wooden back • galvanised steel sheet 1.2 mm
- Width: 26.5 cm • with elastane bristles • matching handle: 2961



Ref. no.	Handle	Colour	Width	Ø handle holder			€
29433	without handle	red	40 cm	27 mm	1	150	
29434	without handle	red	60 cm	27 mm	1	120	

Scrubber

- Wood back with metal handle holder • with polypropylene bristles
- with handle halter • matching handle: 2962

Ref. no.	Handle	Width	Ø handle holder			€
29528	without handle	30 cm	24 mm	1/10	480	

Ref. no.	Description	Material	Length		€
2962	Device and Broom Handle without cone	Aspen Wood	130 cm	1/25	

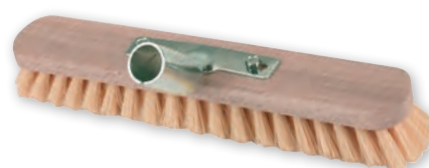

Bucket and Scoop

Water Bucket

- highest corrosion protection
- Material: metal hot-dip galvanised • with handle



Ref. no.	Height	Capacity			€
29181	26 cm	9 L	1/12	396	
2918	27,5 cm	11 L	1/12	396	
2919	28 cm	14 L	1/12	360	

Water Bucket Standard

- made from strip galvanised sheet metal
- with handle



Ref. no.	Capacity			€
29186	11 L	1/12	396	

Stainless Steel Bucket

- highly polished interior and exterior • Material: Stainless Steel AISI 201 • with handle

29377: with embossed measuring scale

Ref. no.	Capacity			€
29375	5,7 L	1/24	480	
29376	8,5 L	1/16	192	
29377	12,3 L	1/12	144	

stainless steel



All-Purpose Bucket

- very sturdy design • Material: Plastic



Top Seller

Made in the EU

Available in customer-specific composition. Note the instructions at the end of the catalogue.

Ref. no.	Description	Colour	Ø	Capacity			€
29881		olive green	33 cm	12 L	1	350	
298800	food safe	blue transparent	33 cm	12 L	1	350	
298801	food safe	transparent pink	33 cm	12 L	1	350	

Ref. no.	Description	Colour		€
29935	Cover for stable and construction bucket	black	1/30	

All-Purpose Bucket Jumbo

- extra-sturdy design • break-proof plastic • extra smooth inner floor for complete draining • with metal carry handle



Made in the EU

Ref. no.	Colour	Capacity			€
29882	green	20 L	1	180	

Available in customer-specific composition. Note the instructions at the end of the catalogue.

Universal Bucket

- very sturdy design • Material: Plastic
- with metal carry handle • food safe

Ref. no.	Colour	Capacity			€
298840	red	10 L	1	600	

Available in customer-specific composition. Note the instructions at the end of the catalogue.



New product

NEW

GEA



Wipers, Crutches and Scrapers

Box rake

- very light and robust
- can be used on both sides
- versatile use, e.g. for cleaning cubicles
- Rake and scraper at the same time



Ref. no.	Handle	Colour	Material	Width	Ø handle holder			€
29244	without handle	black	Nylon fibre-glass reinforced	40 cm	28 - 28,5 mm	1/4/24	288	

Manure Scraper

- with handle halter
- matching handle: 29613



Ref. no.	Handle	Material	Width	Ø handle holder			€
2926	without handle	Sheet metal	35 cm	33 mm	1	500	
2927	without handle	Iron forged	35 cm	33 mm	1	500	

Ref. no.	Description	Material	Length		€
29613	Manure Scraper Handle	ash	150 cm	1/25	

Slurry Pusher

- without thread
- with handle halter

29242: matching handle 29611, 29603, 29604 or 29611

29300: matching handle 29604



Ref. no.	Handle	Colour	Material	Width	Ø handle holder			€
29300	without handle	green	Plastic	40 cm	27 mm	1/20	720	
29242	without handle	blue	Plastic	36 cm	25 mm	1/20	600	

Muck and Slurry Pusher

- very versatile
- with handle halter



Ref. no.	Handle	Colour	Material	Width	Ø handle holder			€
29243	without handle	green	Polypropylene	35 cm	28 mm	1/40	800	

Muck and Slurry Pusher

- very robust thanks to metal reinforcement
- can be used on both sides
- very clean removal of liquids thanks to the integrated lip made from foam rubber
- very versatile, e.g. can also be used as a feed pusher, squeegee or snow shovel
- with handle halter



Ref. no.	Handle	Colour	Material	Width	Ø handle holder			€
29287	without handle	green	Polypropylene	46 cm	27 mm	1/15	300	

Ref. no.	Description	Colour	Width		€
29288	Rubber for muck and slurry pusher	black	46 cm	1/15	

Muck and Slurry Pusher

- with interchangeable, ammonia-resistant rubber scraper • bolted
- high-quality rubber blend with mesh insert guarantees maximum flexibility while preventing the occurrence of fractures and cracks • very long life thanks to low abrasion • with handle halter • matching handle: 29612



High-quality rubber blend with mesh insert

Ref. no.	Handle	Material	Width	Ø handle holder			€
291285	without handle	Steel powder-coated	30 cm	30 mm	1	400	
291266	without handle	Steel powder-coated	35 cm	30 mm	1	350	
291267	without handle	Steel powder-coated	40 cm	30 mm	1	300	
291268	without handle	Steel powder-coated	55 cm	30 mm	1	275	



Ref. no.	Description	Colour	Material	Length	Width		€
291286	Rubber for muck and slurry pusher	black	Rubber		30 cm	1/100	
291271	Rubber for muck and slurry pusher	black	Rubber		35 cm	1/100	
291272	Rubber for muck and slurry pusher	black	Rubber		40 cm	1/100	
291273	Rubber for muck and slurry pusher	black	Rubber		55 cm	1/100	
29612	Handle for muck and slurry pusher		ash	165 cm		1/25	

Muck and Slurry Pusher half round

- with interchangeable, ammonia-resistant rubber scraper • bolted • high-quality rubber blend with mesh insert guarantees maximum flexibility while preventing the occurrence of fractures and cracks • very long life thanks to low abrasion
- shaft holder with wing-nut, infinitely variable • with handle halter • matching handle: 29612



High-quality rubber blend with mesh insert

Ref. no.	Handle	Material	Width	Ø handle holder			€
291269	without handle	Steel powder-coated	66 cm	32 mm	1	120	
291270	without handle	Steel powder-coated	50 cm	32 mm	1	180	



Ref. no.	Description	Colour	Material	Length	Width		€
291274	Rubber for muck and slurry pusher, half round	black	Rubber		66 cm	1/100	
291275	Rubber for muck and slurry pusher, half round	black	Rubber		50 cm	1/100	
29612	Handle for muck and slurry pusher		ash	165 cm		1/25	

Muck and Slurry Pusher half round

- galvanised shaft • bolted • with interchangeable, ammonia-resistant rubber scraper
- high-quality rubber blend with mesh insert guarantees maximum flexibility while preventing the occurrence of fractures and cracks • very long life thanks to low abrasion
- extremely sturdy design with reinforced back • shaft holder with wing-nut, infinitely variable • with handle halter • matching handle: 29612



Ref. no.	Handle	Material	Width	Ø handle holder			€
29232	without handle	Steel galvanised	58 cm	32 mm	1	150	
29233	without handle	Steel galvanised	66 cm	32 mm	1	120	
29234	without handle	Steel galvanised	73 cm	32 mm	1	80	

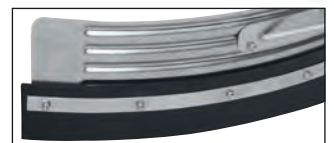

Ref. no.	Description	Material	Length	Width		€
29235	Rubber for muck and slurry pusher, half round	Rubber		58 cm	1/10/50	
29236	Rubber for muck and slurry pusher, half round	Rubber		66 cm	1/10/50	
29237	Rubber for muck and slurry pusher, half round	Rubber		73 cm	1/10/50	
29612	Handle for muck and slurry pusher	ash	165 cm		1/25	

Wipers, Crutches and Scrapers

Squeegee

- universal handle fitting with clamp screw cap: rapid and tool-free fastening of all types of handles with diameters from 18 to 26 mm
- very sturdy construction • with splash guard • high-quality rubber lip made from natural rubber: does not absorb water, long-lasting, wear-resistant, elastic and maintains its shape - for the best results even on rough and uneven ground • firmly riveted rubber lip • Handle holder with clamping screw



Ref. no.	Handle	Material	Width	Ø handle holder			€
29284	without handle	metal galvanised	45 cm	18 - 26 mm	1/10	560	
29285	without handle	metal galvanised	55 cm	18 - 26 mm	1/10	400	
29286	without handle	metal galvanised	75 cm	18 - 26 mm	1/10	320	

TV

Squeegee Premium

- zinc-plated design • very sturdy construction • perfect for professional use and large areas • with removable, screwed-on rubber • with pre-mounted handle holder • with handle halter • matching handle: 2961



Ref. no.	Handle	Material	Width	Ø handle holder			€
29272	without handle	metal galvanised	40 cm	24 mm	1/10	300	
29273	without handle	metal galvanised	50 cm	24 mm	1/10	300	
29274	without handle	metal galvanised	60 cm	24 mm	1/10	250	
29275	without handle	metal galvanised	80 cm	28 mm	1/10	200	



Top Quality

Ref. no.	Description	Colour	Material	Width		€
29276	Rubber for Premium squeegee	black	Rubber	40 cm	1/50	
29277	Rubber for Premium squeegee	black	Rubber	50 cm	1/50	
29278	Rubber for Premium squeegee	black	Rubber	60 cm	1/50	
29279	Rubber for Premium squeegee	black	Rubber	80 cm	1/50	

Squeegee

- zinc-plated design • with splash guard • Natural rubber
- with handle halter • matching handle: 2962

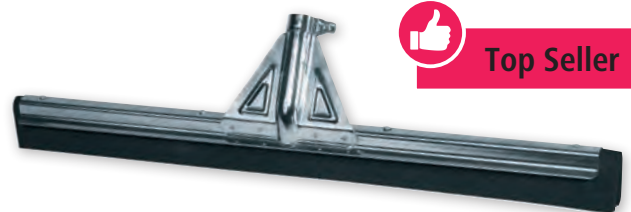

Top Seller

Ref. no.	Handle	Material	Width	Ø handle holder			€
29281	without handle	metal galvanised	45 cm	23 mm	1/10	350	
29282	without handle	metal galvanised	55 cm	23 mm	1/10	250	
29283	without handle	metal galvanised	75 cm	23 mm	1/10	360	

Rubber wiper

- zinc-plated design • without handle • firmly riveted rubber blade to prevent blade from loosening • with handle halter • matching handle: 2962



Ref. no.	Material	Width	Ø handle holder			€
29466	metal galvanised	45 cm	24 mm	1/10	770	
29467	metal galvanised	60 cm	24 mm	1/10	560	

Feed Pusher

- with handle, unmounted • replaceable plastic blade with an anti-stick coating • very versatile, e.g. can also be used as a feed pusher or snow shovel • Plastic blade dimensions: 20 x 61 cm



Ref. no.	Handle	Colour	Length			€
29250	with fibreglass handle and D-grip	red / black	140 cm	1/6	42	

Feed Pusher

- extremely stable and durable • very versatile • suitable for silage, grain, manure or snow • with sharp corners for better accessibility of edges and corners • matching handle: 29246

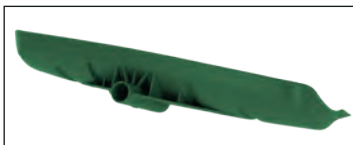

29245



29246



New product

NEW



Ref. no.	Handle	Colour	Material	Width			€
29245	without handle	dark green	Plastic	65 cm	1	180	

Ref. no.	Description	Length		€
29246	Handle for feed pusher with D-grip	112 cm	1	

Aluminium Shovel

- abutment edge, galvanized
- Material thickness: 2 mm
- with handle halter
- matching handle: 29589, 29674, 29585, 29581



Ref. no.	Handle	Size	Material	Width	Ø handle holder			€
2967	without handle	9	Aluminium	36 cm	36 mm	1/10	220	
2970	without handle	7	Aluminium	32 cm	36 mm	1/10	280	
2973	without handle	5	Aluminium	28 cm	36 mm	1/10	350	

Aluminium Shovel Profi

• extra-thick material approx. 2.5 mm • abutment edge, galvanized • with handle halter • matching handle: 29581, 29589, 29674, 29585



2.5 mm material thickness

Ref. no.	Handle	Size	Material	Ø handle holder			€
29675	without handle	9	Aluminium	38 mm	1/10	200	
2977	without handle	7	Aluminium	38 mm	1/10	280	

Aluminium Shovel

• with edge • Material thickness: 2 mm • with handle halter • matching handle: 29583



29691

Ref. no.	Handle	Size	Material			€
29691	with beech handle 135 cm	9	Aluminium	1/5	70	

Special Aluminium Shovel Profi

• with edge • extra-thick material approx. 2.5 mm • Material thickness: 2,5 mm • with handle halter



29679

2.5 mm material thickness

Ref. no.	Handle	Size	Material			€
29679	with beech handle 135 cm	9	Aluminium	1/5	70	

Accessories for Aluminium Shovel and Aluminium Shovel Profi



Ref. no.	Description	Size	Material	Length	Width		€
2969	Edge for aluminium shovel incl. 5 rivets	9			36 cm	1/10/50	
2972	Edge for aluminium shovel incl. 5 rivets	7			32 cm	1/10/50	
29732	Edge for aluminium shovel incl. 4 rivets	5			28 cm	1/10/50	
29721	Rivets for edges					1/5/5.000	
29581	Handle for Shovel 1a quality		ash	130 cm		1/25	

Snow and grain shovel

- various grip options • working positions that are gentle on the body • light and stable • with handle halter
- matching handle: 29589, 29581



Ref. no.	Description	Handle	Colour	Material	Length	Width	Height	Ø handle holder			€
29665	without protective edge	without handle	green	Plastic	42 cm	40 cm	10 cm	39 mm	1/5	150	
29666	with protective edge	without handle	green	Plastic	42 cm	40 cm	10 cm	39 mm	1/5	150	
296710	with protective edge	with aluminium handle and D-grip	green	Plastic	42 cm	40 cm	10 cm	39 mm	1/5	50	

Snow and grain shovel

- various grip options • working positions that are gentle on the body • with handle halter • matching handle: 29589, 29674, 29585, 29581



Ref. no.	Description	Handle	Material	Length	Width	Ø handle holder			€
29670	without protective edge	with beech handle	Aluminium	41 cm	33 cm	39 mm	1/5	50	
29671	with protective edge	without handle	Aluminium	41 cm	33 cm	39 mm	1/5	160	
29667	with protective edge	with aluminium handle and D-grip	Aluminium	41 cm	33 cm	39 mm	1/5	50	

Ref. no.	Description		€
29673	Edge with rivets	1/10/150	

All-purpose Shovel

- versatile, e.g. as a snow or grain shovel • reinforced blade edge
- 4-piece glass fibre reinforced handle • Handle is robustly inserted and screwed together • comes disassembled in cardboard box
- matching handle: 29699



Plug-in system for two lengths!





Ref. no.	Description	Handle	Colour	Width	Height			€
29697	without protective edge	with glass fibre reinforced handle and D-grip	red	44 cm	40 cm	1	100	
29698	with protective edge	with glass fibre reinforced handle and D-grip	red	29 cm	36 cm	1	112	

European high-quality forks made of premium steel!

Litter fork

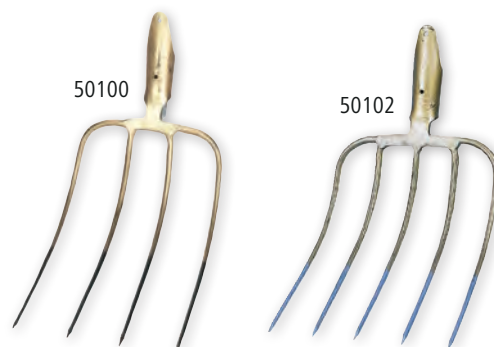
- hand-forged and hardened • with spring sleeve
- matching handle: 29581, 2959



Ref. no.	Handle	Material	Length	Width	Tines	Ø handle holder			€
50100	without handle	Steel	31 cm	23 cm	4	38 mm	1/5	500	
50102	without handle	Steel	31 cm	24 cm	5	38 mm	1/5	400	

Bedding Fork

- hand-forged and hardened • with spring sleeve
- matching handle: 29581, 2959

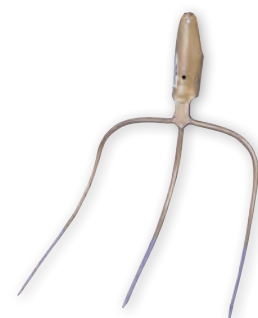



Ref. no.	Handle	Material	Length	Width	Tines	Ø handle holder			€
50104	without handle	Steel	30 cm	30 cm	3	38 mm	1/5	500	

Bedding and Bale Fork

- hand-forged and hardened • with grommet
- matching handle: 29581, 2959





Ref. no.	Handle	Material	Length	Width	Tines	Ø handle holder			€
502720	without handle	Steel	26 cm	13 cm	2	38 mm	1/5	600	
50105	without handle	Steel	28 cm	21 cm	3	38 mm	1/5	600	
50106	without handle	Steel	26 cm	20 cm	3	38 mm	1/5	600	

Dung Rake

- hand-forged and hardened • with grommet
- matching handle: 29581, 2959



All forks are forged from a single piece!

Ref. no.	Handle	Material	Length	Width	Tines	Ø handle holder			€
29115	without handle	Steel	21 cm	20 cm	4	38 mm	1/5	500	
294430	without handle	Steel	21 cm	17 cm	3	38 mm	1/5	500	

Moisture Meter for hay and straw

- Portable digital device for the determination of moisture and temperature in pressed hay and straw
- incl. 68 cm long sensor that registers changes in the electrical conductivity of hay and straw and turns them into moisture percentages
- can store up to 50 measurement results
- operated with: 1 x 9 V - Block PP3 • Battery included



Technical data	29356
Battery Operation	1 x 9 V - Block PP3
Display	LCD 1 x 3-digit
Temperature measuring range	1 - 100 °C
Moisture measurement accuracy	10 - 80 %
Sensor cable length	100 cm

Ref. no.	Colour		€
29356	yellow	1/20	

Hay Cutter Hay Cutter TF 2000 M

- suitable for vertical as well as horizontal cutting of hay bales, allows for dust free working
- its perfect cutting, handling and ease of use without maintenance requirements reduce labour costs
- the TF 2000 M hay cutter is perfect for cutting hay bales, pressed fodder and silage (e.g. hay, corn, millet, beet leaves or grass silage in a clamp silo)
- with closed blade
- cuts round hay bales without raker
- Sound pressure level: 103.5 LWA
- Vibration level ISO 5349: 5.9 m/sec²



Technical data	29190
Voltage	230 V
Mains frequency	50 Hz
Power	1.400 W
Weight	13,4 kg
Cutting width	25 cm
Cutting height	60 cm
Sound pressure level	89,9 LpAm



Ref. no.	Colour		€
29190	black / blue	1	



Outlet Raimo BigBag

- for easy and controlled emptying of BigBags with the help of a resealable slider
- suitable for all kinds of free-flowing materials such as seeds, fertilisers, feed etc.
- unused materials stays in the BigBag, meaning no waste
- can be applied to the empty or already filled sacks in seconds – the integrated blades cut the hole when rotated, even in the BigBag
- extremely robust and reusable



Ref. no.	Description			€
29389	with extension	1	76	
29425	without extension	1	126	

Strip Curtain Set

Set consisting of: 5 x PVC strips 30 x 225 cm, 3 mm thick, 5 x hanging panels 30 cm, 2 x hook strips (total length 130 cm)



Hanging panels pre-mounted on PVC strips

Ref. no.			€
291162	1	16	

Ref. no.	Description	Length	Width	MOQ	Pieces / unit		€
291163	PVC Strips punched and assembled	225 cm	30 cm			1	
291154-1	Screw and Nut Set for hanging panels			1 pouch	8 / pouch	1	



Made for long-lasting use in harsh environments!

Put your trust in Kerbl's experience: Our lights were specially developed for lasting use in stables and similarly demanding environments.

As well as high stress due to humidity and dust, lights in stables are exposed to a lot of chemicals in the ambient air and due to cleaning processes. In particular, lights have to be able to withstand high concentrations of ammonia.

Therefore, to ensure a long service life, we focus our efforts on the technical design, the use of suitable electronic components and materials, and high-quality workmanship of our LED lights. And we don't just rely on our own expertise – we also put our products through special safety and load tests by independent and recognised testing institutes such as TÜV Süd and the DLG Test Lab.

Our LED indoor spotlights and MultiLED Pro and FarmPRO lights have passed ammonia resistance tests at the DLG Test Lab.



KERBL HALLENSTRAHLER

✓ Ammoniakbeständigkeit

DLG-Prüfbericht 7019



KERBL MULTILED PRO

✓ Ammoniakbeständigkeit

DLG-Prüfbericht 7017



KERBL FEUCHTRAUMLEUCHE FARMPRO

✓ Ammoniakbeständigkeit

DLG-Prüfbericht 7018

LED technology in the stable pays off

LEDs operate at a high level of effectiveness and are extremely efficient. Their luminous efficacy is therefore especially high.

As a rule, the investment costs for new equipment or a conversion are currently still higher than for conventional lighting; however these costs will pay for themselves over a short time due to the considerable savings in running costs.

More light means more milk

Lighting duration, lighting intensity and light colour all have a major impact on lactation, fertility and the well-being of animals. In dairy cattle farming, lighting management is therefore extremely important.

Scientific studies have shown that daily milk production can be increased by 5 – 15 % on average during long daylight phases with 16 hours of light and 8 hours of darkness. However, this requires a uniform lighting strength of 150 – 200 lux.



345835

LED Indoor Spotlight

LED light for lighting stables, riding halls, industrial buildings and warehouses

- resistant to ammonia (DLG-tested) • ideal for high-ceiling structures • with energy efficient SMD chips from Philips
- excellent light yield • high colour temperature for fatigue-free visibility • with D marking according to DIN EN 60598-2-24, therefore suitable for areas at risk of fires due to combustible dusts or fibres (hay storage, feed, litter, etc.)
- direct or suspended ceiling installation • special heat sink shape for optimised heat dissipation • protected against powerful water jets and dust-proof (IP 65 protection class) • Light angle: 110 ° • Voltage: 100 - 240 V
- suitable for outdoor use • 5-year warranty • TÜV-GS approved

New product

NEW

5-year warranty

5

In combination with the lighting control system (item no. 345000), it is ideally suited to help minimise energy costs, optimise the milk and growth output of the animals and increase comfort for both people and the animal



Technical data

Voltage	100 - 240 V
Mains frequency	50 - 60 Hz
Luminous efficacy	132 lm/W
Light angle (half intensity angle)	110 °
Chip service life (L70)	> 100.000 h
Dimming function (only with dimmable lamps)	1...10 V, 10 V PWM, 0 - 100 kΩ resistance
Material	Die-cast aluminium with anti-corrosion coating
Operating ambient temperature	-40 - 60 °C
Colour rendering (CRI)	Ra > 80
Protection class	IP65



Ref. no.	Power	Ø	Dimming function	Luminous flux	Colour temperature			€
345805	100 W	280 mm	cannot be dimmed	13.200 lm	5.700 K	1	24	
345815	150 W	320 mm	cannot be dimmed	19.800 lm	5.700 K	1	21	
345825	200 W	365 mm	cannot be dimmed	26.400 lm	5.700 K	1	28	
345835	240 W	400 mm	cannot be dimmed	31.680 lm	5.700 K	1	28	
345810	150 W	320 mm	dimmable	19.800 lm	5.700 K	1	24	
345830	240 W	400 mm	dimmable	31.680 lm	5.700 K	1	24	

Ref. no.	Description		€
345802	Metal Bracket for Ceiling/Wall Mounting	1/20	

The lights comprise built-in LED bulbs. The bulbs in the light cannot be replaced.



MultiLED pro

LED light for lighting stables, riding halls, industrial buildings and warehouses

- optimal light distribution via individually adjustable modules
- excellent heat dissipation due to a solid heat sink
- high-quality materials for use in tough environments
- very high ammonia-resistant
- protected against powerful water jets and dust-proof (IP 65 protection class)
- with D marking according to DIN EN 60598-2-24, therefore suitable for areas at risk of fires due to combustible dusts or fibres (hay storage, feed, litter, etc.)
- direct or hanging ceiling installation with adjustable mounting brackets or eyelets
- incl. dimming function (can be controlled via a 1 - 10 V, PWM or resistance signal)
- with energy efficient SMD chips from Philips
- Light angle: 110 °
- Voltage: 100 - 277 V
- suitable for outdoor use
- 5-year warranty



In combination with the lighting control system (item no. 345000), it is ideally suited to help minimise energy costs, optimise the milk and growth output of the animals and increase comfort for both people and the animal

Technical data

Voltage	100 - 277 V
Mains frequency	50 - 60 Hz
Luminous efficacy	120 - 130 lm/W
Light angle (half intensity angle)	110 °
Chip service life (L70)	> 100.000 h
Dimming function (only with dimmable lamps)	1...10 V, 10 V PWM, 0 - 100 kΩ resistance
Operating ambient temperature	-40 - 50 °C
Colour rendering (CRI)	Ra > 80
Protection class	IP65

Ref. no.	Power	Length	Width	Height	Dimming function	Luminous flux	Colour temperature			€
345985	150 W	430 mm	298 mm	350 mm	dimmable	19.500 lm	5.700 K	1	20	
345990	300 W	580 mm	298 mm	430 mm	dimmable	36.000 lm	5.700 K	1	12	

The lights comprise built-in LED bulbs. The bulbs in the light cannot be replaced.



5-year warranty





control unit for LED lighting

This lighting control allows you to switch the artificial stable lighting on or off, on a timer and regardless of existing daylight, or even achieve a constant light level (e.g. min. 200 lux) through automatic dimming. This means it ensures ideal lighting conditions throughout the day and year while minimising electricity consumption. Comfort for animals and humans!

- controls lighting dependent on time and/or daylight
- four different lighting circuits (groups) can be independently controlled, two of which with a dimming function
- suitable for LED lights with 1...10V interface
- standard surface-mount housing for mounting in the equipment room
- Dust and moisture protection (IP54)
- suitable e.g. for up to 50 150 watt lights (up to 15 lights on the dimmable circuits 1 and 2, and up to 10 lights on circuits 3 and 4)
- supplied with a light sensor (can request up to four light sensors)
- input for up to four button signals
- easy to use with display and three buttons
- with extensive documentation and terminal description
- IP65



easy to install by your electric company

Technical data	345000
Supply voltage	230 V / 400 V
Fuse	B16 A
Pole Connectors	3-pin
Max. current value per output	16 A
Max. total power circuit 3 and 4	16 A
Number of circuits	4
Number of dimmable circuits	2
Max. switching capacity	11 kVA
Dimming function circuit 1 and 2	1...10 V
Number of max. light sensors	4
Number of max. button signals	4
Protection class	IP65

Ref. no.	Material	Width	Height		€
345000	Plastic	300 mm	450 mm	1	

Ref. no.	Description		€
345001	Sensor for control	1	



345001

LED Tubes and Moisture-proof Lights

The LED tubes EcoTUBE and EcoTUBE Plus come with the latest LED technology and their high light output, high efficiency and extremely attractive price-performance ratio cannot fail to impress.

Compared with conventional fluorescent tubes, you can save a great deal on energy costs and enjoy many other benefits as well:

- very long service life and high switching durability
- full light output even at low temperatures
- full, immediate luminosity, no flickering, no humming
- uniform and glare-free illumination
- high colour reproduction (Ra > 80), suitable for nearly all operating sites according to workplace guidelines
- sturdy housing
- mercury-free

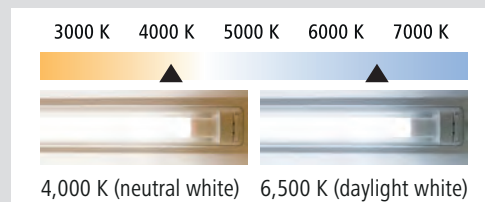

LED Tube EcoTUBE

• Lamp tube made out of glass with special plastic coating to prevent sagging while also ensuring optimal splinter protection • very high light angle ensures particularly uniform illumination • flicker-free, thus also for poultry with high visual acuity • very efficient through high lumen output • only suitable for lights with conventional electro-magnetic ballasts (conventional ballasts/low-loss ballasts). • Light angle: 210 ° • Lamp Base: G13 • Voltage: 220 - 240 V • 5-year warranty • TÜV tested

Technical data	
Voltage	220 - 240 V
Mains frequency	50 - 60 Hz
Light angle (half intensity angle)	210 °
Chip service life (L70)	> 50.000 h
Colour rendering (CRI)	Ra > 80
Lamp Base	G13
Bulb shape	T8
Energy efficiency class	A++

flicker-free



5-year warranty



New product

NEW

Ref. no.	Power	Length	Dimming function	Luminous flux	Colour temperature	MOQ	Pieces / unit		€
345610	21 W	150 cm	cannot be dimmed	2.750 lm	6.500 K	10 pieces	10 / box	1/10	
345611	17 W	120 cm	cannot be dimmed	2.200 lm	6.500 K	10 pieces	10 / box	1/10	

LED Tube EcoTUBE Plus

• Lamp tube made out of glass with special plastic coating to prevent sagging while also ensuring optimal splinter protection • very high light angle ensures particularly uniform illumination • flicker-free, thus also for poultry with high visual acuity • very high light output • extremely efficient through high lumen output • only suitable for lights with conventional electro-magnetic ballasts (conventional ballasts/low-loss ballasts). • Light angle: 210 ° • Lamp Base: G13 • Voltage: 220 - 240 V • 5-year warranty • TÜV tested

Technical data	
Voltage	220 - 240 V
Mains frequency	50 - 60 Hz
Light angle (half intensity angle)	210 °
Chip service life (L70)	> 50.000 h
Colour rendering (CRI)	Ra > 80
Lamp Base	G13
Bulb shape	T8
Energy efficiency class	A++

flicker-free



5-year warranty



New product

NEW

Ref. no.	Power	Length	Dimming function	Luminous flux	Colour temperature	MOQ	Pieces / unit		€
345614	24 W	150 cm	cannot be dimmed	3.600 lm	4.000 K	10 pieces	10 / box	1/10	
345612	24 W	150 cm	cannot be dimmed	3.600 lm	6.500 K	10 pieces	10 / box	1/10	
345615	18 W	120 cm	cannot be dimmed	2.700 lm	4.000 K	10 pieces	10 / box	1/10	
345613	18 W	120 cm	cannot be dimmed	2.700 lm	6.500 K	10 pieces	10 / box	1/10	

LED Tubes and Moisture-proof Lights

Moisture-proof diffuser light for LED tubes

• housing made from glass fibre reinforced polyester, low inflammability • cover made from acrylic glass (PMMA), transparent, pearled interior, with clip locks • protected against powerful water jets and dust-proof (IP 65 protection class) • with D marking according to DIN EN 60598-2-24, therefore suitable for areas at risk of fires due to combustible dusts or fibres (hay storage, feed, litter, etc.) • incl. microfuse • no bridging starter required • only suitable for T8 LED Tubes (Ø 26 mm) • suitable for LED tubes EcoSTAR and EcoSTAR Plus • 2-year warranty



Made in Germany



Technical data	
Protection class	IP65
Protection class	I

Ref. no.	Colour	Length			€
34561	white	120 cm	1	120	
34562	white	150 cm	1	120	

Light source not included!

Moisture-proof diffuser light for LED tubes

• only suitable for T8 LED tubes • no bridging starter required • protected against powerful water jets and dust-proof (IP 65 protection class) • unbreakable housing with a high resistance to ammonia • with D marking according to DIN EN 60598-2-24, therefore suitable for areas at risk of fires due to combustible dusts or fibres (hay storage, feed, litter, etc.) • incl. installation clips made of stainless steel • Lamp Base: G13



New product

NEW



Technical data	
Protection class	IP65
Protection class	I

Ref. no.	Length		€
345670	120 cm	1/12	
34567	150 cm	1/9	

Light source not included!

LED moisture-proof lamp FarmSTAR

Perfect for rough conditions in wet, moist or dusty environments!

• for lighting stables, riding halls, industrial buildings and warehouses, barns, workshops, etc. • with integrated high-performance LED chips (no fluorescent tubes required) • protected against powerful water jets and dust-proof (IP 65 protection class) • with D marking according to DIN EN 60598-2-24, therefore suitable for areas at risk of fires due to combustible dusts or fibres (hay storage, feed, litter, etc.) • stable, shock-resistant housing made from ABS plastic • uniform and glare-free illumination due to a frosted cover • incl. installation clips made of stainless steel • Light angle: 140 ° • Voltage: 220 - 240 V • 2-year warranty • D-label



Technical data	
Voltage	220 - 240 V
Mains frequency	50 - 60 Hz
Luminous efficacy	2.000 lm/W
Light angle (half intensity angle)	140 °
Chip service life (L70)	> 30.000 h
Material	ABS plastic
Colour rendering (CRI)	Ra > 80
Protection class	IP65
Protection class	I

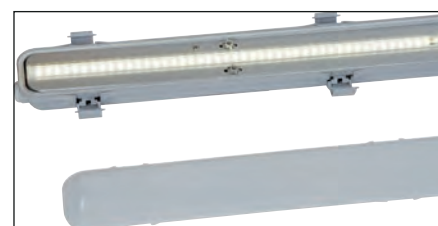

Ref. no.	Power	Length	Width	Height	Dimming function	Luminous flux	Colour temperature			€
34558	25 W	120 cm	7,5 cm	7,8 cm	cannot be dimmed	2.000 lm	6.500 K	1/9	81	

The lights comprise built-in LED bulbs. The bulbs in the light cannot be replaced.

LED Tubes and Moisture-proof Lights

LED moisture-proof lamp FarmPRO

Perfect for animal stalls!

- suitable for low to medium-high ceiling heights • extremely tough aluminium housing with safety glass – no plastic content • resistant to ammonia (DLG-tested) • flicker-free, thus also for poultry with high visual acuity • protected against powerful water jets and dust-proof (IP 65 protection class) • with D marking according to DIN EN 60598-2-24, therefore suitable for areas at risk of fires due to combustible dusts or fibres (hay storage, feed, litter, etc.) • with integrated high-power LED chips from Philips • very high efficiency and energy cost savings • extremely high service life and switching capacity • high colour reproduction (Ra > 80), suitable for nearly all operating site according to workplace guidelines • incl. installation clips made of stainless steel • incl. 1 m connection cable with stainless steel screw connections • Light angle: 112 ° • Voltage: 100 - 277 V • 5-year warranty • DLG tested

specially developed for use in livestock barns

Technical data	
Voltage	100 - 277 V
Mains frequency	50 - 60 Hz
Luminous efficacy	130 lm/W
Light angle (half intensity angle)	112 °
Chip service life (L70)	> 100.000 h
Colour rendering (CRI)	Ra > 80
Protection class	IP65
Protection class	I



5-year warranty



Ref. no.	Power	Length	Dimming function	Luminous flux		€
345616	40 W	90 cm	cannot be dimmed	5.200 lm	1/6	
345617	60 W	120 cm	cannot be dimmed	7.800 lm	1/4	



The lights comprise built-in LED bulbs. The bulbs in the light cannot be replaced.

LED moisture-proof lamp

Perfect for rough conditions in wet, moist or dusty environments!

- for lighting stables, riding halls, industrial buildings and warehouses, barns, workshops, etc. • with integrated high-performance LED chips (no fluorescent tubes required) • high energy cost savings compared to regular T8 fluorescent lamps • water-proof and dust-proof (IP 67 protection class), corrosion-protected • with D marking according to DIN EN 60598-2-24, therefore suitable for areas at risk of fires due to combustible dusts or fibres (hay storage, feed, litter, etc.) • stable, shock-resistant housing made from polycarbonate • uniform and glare-free illumination due to a frosted cover • incl. installation clips made of stainless steel • Light angle: 130 ° • Voltage: 100 - 277 V • 5-year warranty

Technical data	
Voltage	100 - 277 V
Mains frequency	50 - 60 Hz
Luminous efficacy	120 - 125 lm/W
Light angle (half intensity angle)	130 °
Chip service life (L70)	> 50.000 h
LED type	SMD 2835
Operating ambient temperature	-40 - 50 °C
Colour rendering (CRI)	Ra > 80
Protection class	IP67
Energy efficiency class	A++



5-year warranty



Ref. no.	Power	Length	Width	Height	Luminous flux	Colour temperature			€
34546	40 W	1.192 mm	72 mm	82 mm	5.000 lm	6.000 K	1/6	48	
34547	55 W	1.492 mm	72 mm	82 mm	6.500 lm	6.000 K	1/6	48	

The lights comprise built-in LED bulbs. The bulbs in the light cannot be replaced.



LED Outdoor Spotlight

The LED outdoor lamps reflect the latest LED technology and boast efficiency, compact design and an extremely attractive price-performance ratio! Compared to conventional spotlights, you can achieve a high level of cost savings and enjoy the many other benefits of LED lighting.

- compact design • for lighting stalls, barns, sheds etc. • with energy-efficient, SMD LED chips • up to 80 % less power consumption • uniform and glare-free illumination due to a frosted cover • robust housing made from cast aluminium with safety glass • with adjustable clamping bracket • incl. 1 m connection cable • Light angle: 100 °
- Voltage: 220 - 240 V • suitable for outdoor use • 2-year warranty • GS-tested

New product

NEW



345687

345680



Technical data	
Voltage	220 - 240 V
Mains frequency	50 Hz
Luminous efficacy	80 lm/W
Light angle (half intensity angle)	100 °
Chip service life (L70)	> 30.000 h
LED type	SMD
Material	Die-cast aluminium
Colour rendering (CRI)	Ra > 65
Switch cycles	> 15.000
Cable length	100 cm
Protection class (without motion sensor)	IP65
Protection class (with motion sensor)	IP44

Ref. no.	Description	Power	Width	Height	Depth	Dimming function	Luminous flux	Colour temperature			€
345680	without motion sensor	10 W	106 mm	114 mm	38 mm	cannot be dimmed	800 lm	6.000 K	1/24	864	
345681	without motion sensor	20 W	136 mm	121 mm	47 mm	cannot be dimmed	1.600 lm	6.000 K	1/16	512	
345682	without motion sensor	30 W	180 mm	156 mm	62 mm	cannot be dimmed	2.400 lm	6.000 K	1/12	360	
345683	without motion sensor	50 W	230 mm	220 mm	67 mm	cannot be dimmed	4.000 lm	6.000 K	1/8	192	
345684	without motion sensor	100 W	285 mm	250 mm	64 mm	cannot be dimmed	8.000 lm	6.000 K	1/4	128	
345685	with motion detector	10 W	106 mm	150 mm	70 mm	cannot be dimmed	800 lm	6.000 K	1/24	576	
345686	with motion detector	20 W	136 mm	158 mm	70 mm	cannot be dimmed	1.600 lm	6.000 K	1/16	288	
345687	with motion detector	30 W	180 mm	191 mm	71 mm	cannot be dimmed	2.400 lm	6.000 K	1/12	324	
345688	with motion detector	50 W	230 mm	238 mm	71 mm	cannot be dimmed	4.000 lm	6.000 K	1/8	128	
345689	with motion detector	100 W	335 mm	330 mm	64 mm	cannot be dimmed	8.000 lm	6.000 K	1/4	96	

NEW

The spotlights comprise built-in LED bulbs. The bulbs in the light cannot be replaced.



LED Oval Light

- ideal for passage areas, garage, basement, etc. • sturdy plastic housing with glazed cover
- Splash-proof • ceiling or wall mounting • with energy-efficient, SMD LED chips • up to 80 % less power consumption • Light angle: 100 ° • Voltage: 220 - 240 V • suitable for outdoor use
- 2-year warranty • TÜV-GS approved



GEA



Technical data	345606
Voltage	220 - 240 V
Mains frequency	50 Hz
Luminous efficacy	80 lm/W
Light angle (half intensity angle)	100 °
Chip service life (L70)	> 30.000 h
Colour rendering (CRI)	Ra > 80
Protection class	IP54



Ref. no.	Power	Length	Width	Height	Dimming function	Luminous flux	Colour temperature			€
345606	5,5 W	16,9 cm	11,5 cm	7,6 cm	cannot be dimmed	450 lm	6.500 K	1/12/24	432	

The lights comprise built-in LED bulbs. The bulbs in the light cannot be replaced.

Mobile LED Battery Spotlight WorkFire Pro 30

- sturdy plastic housing • steplessly adjustable stand • with additional carry handle / mounting bracket • incl. power bank function • Li-ion battery with a charge status display and integrated overcharging and deep discharging protection • LED source: 30 W COB
- incl. USB cable and USB power pack • Dual operation (battery/cable) • with On/Off switch • dust-proof jet-proof • suitable for outdoor use

New product

NEW

Technical data	345608
Luminous efficacy	83 lm/W
Chip service life (L70)	> 50.000 h
Light levels	3 light levels
Light level modes	100 % / 50 % / Warning light flashing red
Material	Plastic
Voltage	5 V
Battery technology	Li-Ion
Battery capacity	8.000 mAh
Battery charge time	8 h
Hours of light	~ 1,5 h 100 %, ~ 3 h 50 %, ~ 6 h Flashing
Colour rendering (CRI)	Ra > 70
Protection class	IP65



Ref. no.	Colour	Power	Length	Width	Height	Luminous flux	Colour temperature			€
345608	black / yellow	30 W	20,5 cm	18 cm	6,5 cm	2.500 lm	6.500 K	1/4/8	192	



Mobile LED Battery Spotlight WorkFire Pro

- sturdy plastic housing with silicon edge protection
- adjustable stand, can also be used as a carrying handle or mounting bracket
- Li-ion battery with a charge status display and integrated overcharging and deep discharging protection
- confusion-proof low-heat device charging cable with earthed plug
- with energy-efficient, SMD LED chips
- up to 80 % less power consumption
- with On/Off switch
- Splash-proof impact and shock-resistant
- suitable for outdoor use
- 2-year warranty
- Battery built-in



Technical data	
Luminous efficacy	80 lm/W
Chip service life (L70)	> 35.000 h
Light levels	3 light levels
Light level modes	100 % / 50 % / 20 %
Voltage	7,4 V
Battery technology	Li-Ion
Battery capacity	4.400 mAh
Battery charge time	5 hours
Hours of light	approx. 2,5 h, approx. 5 h, approx. 8 h
Colour rendering (CRI)	Ra > 80
Protection class	IP54
Energy efficiency class	A++



Ref. no.	Colour	Power	Length	Width	Height	Luminous flux	Colour temperature			€
345605	black / yellow	20 W	23 cm	16 cm	6 cm	1.600 lm	6.000 K	1/6	360	

The lights comprise built-in LED bulbs. The bulbs in the light cannot be replaced.

LED Floodlight

- robust housing made from cast aluminium with safety glass
- robust tubular frame with cable bracket
- with adjustable clamping bracket
- with plastic carrying handle
- 230 volt connecting cable with earthed plug, length 3 m
- with energy-efficient, SMD LED chips
- up to 80 % less power consumption
- Light angle: 100 °
- Voltage: 220 - 240 V
- suitable for outdoor use
- 2-year warranty
- GS-tested



Technical data	
Voltage	220 - 240 V
Mains frequency	50 Hz
Luminous efficacy	75 lm/W
Light angle (half intensity angle)	100 °
Chip service life (L70)	> 35.000 h
LED type	SMD
Material	Die-cast aluminium
Colour rendering (CRI)	Ra > 80
Cable length	3 m
Protection class	IP65



Ref. no.	Colour	Power	Length	Width	Height	Dimming function	Luminous flux	Colour temperature			€
345604	yellow / black	50 W	32 cm	22 cm	40 cm	cannot be dimmed	3.750 lm	6.000 K	1/2	32	

The lights comprise built-in LED bulbs. The bulbs in the light cannot be replaced.

Electric fly killers orig. Halley

- Cost-efficient and economical: Low energy consumption
- Effective and practical: Works both in daylight and artificial light.
- Suitable for hanging (holding eyelet) or standing.
- since 1985



GEA



Halley Insect Killers 2138

- Splash protection (IP 44) for the special conditions in agriculture

Technical data	299804
Voltage	230 V
Mains frequency	50 Hz
Effective area	150 m ²
High voltage	5.000 V
Protection class	IP44
Housing material	Aluminium
Dimensions (W x D x H)	51 x 12 x 39 cm

Ref. no.	Lamps			€
299804	2 x 15 W	1	40	

Ref. no.	Description	Power	Colour		€
299811	Spare Pipe	15 W	blue	1/25	



Made in Italy



Halley Insect Killers Green Line

- the proven fly trap now also with green fluorescent tubes
- Testimonials have shown that flies and insects are more attracted to green light tubes than blue ones under certain circumstances. This can greatly increase the catch numbers of the "green line" fly killer as opposed to the standard blue model.
- Splash protection (IP 44) for the special conditions in agriculture

Technical data	299806	299807
Voltage	230 V	230 V
Mains frequency	50 Hz	50 Hz
Effective area	300 m ²	300 m ²
High voltage	5.000 V	5.000 V
Protection class	IP44	IP44
Housing material	Aluminium	Aluminium
Dimensions (W x D x H)	66 x 12 x 31 cm	66 x 12 x 52 cm

Ref. no.	Description	Lamps			€
299806	Mod. 2214/B	2 x 20 W	1	36	
299807	Mod. 2214	2 x 20 W	1	22	

Ref. no.	Description	Power	Colour		€
299819	Spare Pipe	20 W	green	1/25	

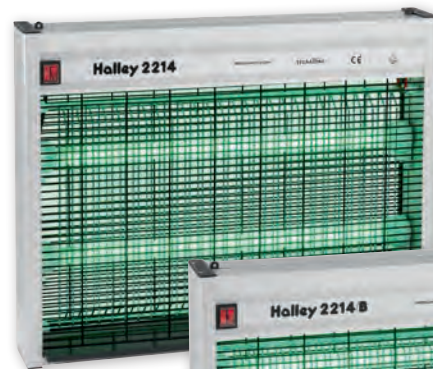

299807



299806

Made in Italy



Insect Killers EcoKill Inox

The electric fly killer with a high-quality stainless steel housing. All EcoKill Inox models are TÜV-GS tested and fitted with long-life UV lamps. The high-quality stainless steel matte-look housing is easy to clean and retains its attractive surface for years. The slim design with the exposed mesh facilitates optimum capture properties.

- extremely robust thanks to stainless steel housing
- Including suspension chain and collecting tray
- outstanding value for money
- corrosion-resistant and scratchproof
- special UVA lamp which is very attractive to insects

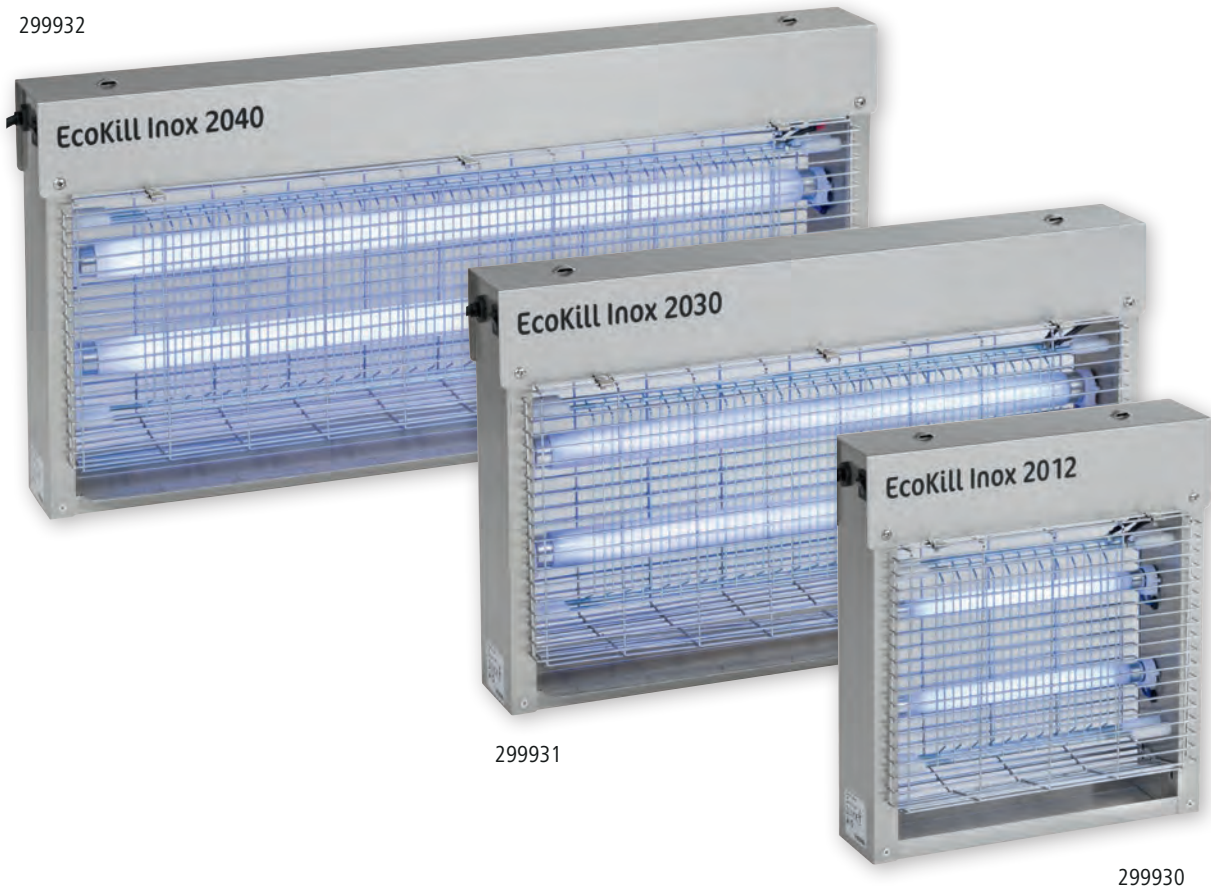

299932



299931

299930

Technical data	299930	299931	299932
Voltage	230 V	230 V	230 V
Mains frequency	50 Hz	50 Hz	50 Hz
Effective area	80 m ²	150 m ²	200 m ²
High voltage	2.200 V	2.200 V	2.200 V
Housing material	stainless steel	stainless steel	stainless steel
Dimensions (W x D x H)	34 x 11,5 x 32,5 cm	56 x 11,5 x 32,5 cm	72 x 12 x 32,5 cm

Ref. no.	Description	Lamps			€
299930	Model 2012	2 x 6 W	1/3	108	
299931	Model 2030	2 x 15 W	1/3	60	
299932	Model 2040	2 x 20 W	1/2	48	

Ref. no.	Description	Power	Colour		€
299812	Spare Pipe	6 W	blue	1/25	
299986	Spare Pipe	15 W	blue	1/25	
299987	Spare Pipe	20 W	blue	1/25	



Insect Killers EcoKill

- extremely lightweight aluminium construction
- Including suspension chain and collecting tray
- outstanding value for money
- corrosion-resistant and scratchproof
- special UVA lamp which is very attractive to insects



Top Seller



Technical data	299950
Voltage	230 V
Mains frequency	50 Hz
Effective area	150 m ²
High voltage	2.200 V
Housing material	Aluminium
Dimensions (W x D x H)	49 x 11 x 34 cm

Ref. no.	Lamps			€
299950	2 x 15 W	1/3	48	

Ref. no.	Description	Power	Colour		€
299811	Spare Pipe	15 W	blue	1/25	

Insect Killers EcoKill Inox IPX4

The fly killer with splash-proof electronics! IPX4 ensures adequate safety in areas such as stalls, outdoors or simply anywhere that a certain level of moisture cannot be ruled out! Identical in terms of shape, performance data and design to the EcoKill Inox without splash protection!

299936

299935

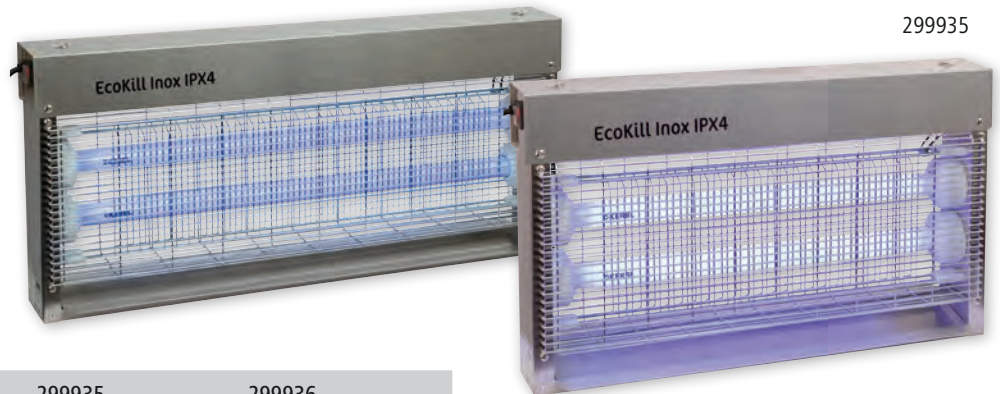

Technical data	299935	299936
Voltage	230 V	230 V
Mains frequency	50 Hz	50 Hz
Effective area	150 m ²	200 m ²
Protection class	IPX4	IPX4
Housing material	stainless steel	stainless steel
Dimensions (W x D x H)	56 x 11,5 x 32,5 cm	72 x 12 x 32,5 cm

Ref. no.	Lamps			€
299935	2 x 15 W	1/3	60	
299936	2 x 20 W	1/2	48	

Ref. no.	Description	Power	Colour		€
299986	Spare Pipe	15 W	blue	1/25	
299987	Spare Pipe	20 W	blue	1/25	





cit Fly roll 3D

- Adhesive catcher with special 3D print to combat flies and flying insects
- the 3D printing simulates edges and stripes and thus potential landing sites for flies – this increases the attractiveness to flies
 - with new improved adhesive coating
 - 100 % non-toxic

New product

NEW





Ref. no.	Roll length	Roll width			€
299904	9 m	30 cm	1/15	540	
299905	7 m	10 cm	1/70		

Stable Fly Roll ECO

- glue trap for controlling flies and flying insects • 100 % non-toxic



Ref. no.	Roll length	Roll width	Fastening			€
299790	10 m	25 cm	with tether	1/24	864	



Top Seller

approved for use on organic farms



Fly roll

- glue trap for controlling flies and flying insects • with yellow paper for even greater attraction of flies and insects • with new improved adhesive coating • 100 % non-toxic



Ref. no.	Roll length	Roll width	Fastening			€
29978	7 m	30 cm	with hanger	1/15	540	



Top Seller

Made in the EU



approved for use on organic farms



Fly roll

- flies are attracted by the paper and remain stuck on the trap
- the new form of printing on yellow paper improves the attractant's appeal, since it simulates apparent landing spots
- simple - clean - non-toxic - 100 % effective • 100 % non-toxic



with yellow paper attractant

Made in the EU



approved for use on organic farms



Ref. no.	Roll length	Roll width	Fastening			€
299847	9 m	30 cm	with hanger	1/15	540	

Fly roll JumboXL

- the new form of printing on yellow paper improves the attractant's appeal, since it simulates apparent landing spots
- simple - clean - non-toxic - 100 % effective
- Stable fly reel with large capture surface at an absolute bargain price



Fly roll with XL catching surface of 4 m²

Made in the EU



approved for use on organic farms



Ref. no.	Roll length	Roll width	Fastening			€
299789	10 m	40 cm	with hanger	1/15	450	

Stable Flypaper Sheet FlyMaster

- 6 sheets each 595 x 300 mm
- flyMaster Flypaper reliably catches flies due in stables, milking parlours and inside houses
- You can catch up to 5,000 flies and/or cover around 200 m² with one sheet
- Usage: Hang the whole or cut fly sheet – remove protective film – finished!
- 100 % non-toxic



with yellow paper attractant

Made in the EU



Ref. no.	Length	Width			€
299842	59,5 cm	30 cm	1/50	1.400	

Made in the EU



Stable Fly Catcher FlyMaster Complete Set

- environmentally-friendly alternative for stable fly control
- spent material is rolled onto the empty reel (included)
- easy self assembly
- Spare rolls can be easily replaced



29976



299776



29976

100 % non-toxic

Ref. no.	Description	Roll length			€
29976	Adhesive tape	400 m	1	96	
299776	Adhesive Cord	440 m	1	96	

Ref. no.	Description	Roll length		€
299777	Roll FlyMaster Stable Fly Catcher Adhesive Cord	440 m	1	
29977	Roll FlyMaster Stable Fly Catcher Adhesive tape	400 m	1	

29977



Roll Stable Fly Catcher

- Spare Fly Trap Roll, suitable for e.g. systems from Flyson, Fly-End, Silva

Ref. no.	Roll length			€
299779	440 m	1	240	

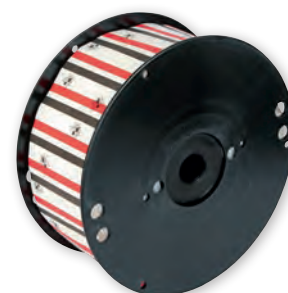

Fly Trap FlyCage2

- the number of flying insects caught can provide an indication of an infestation or high numbers, allowing control measures to be instigated
- easy to use, very effective
- effective for 4 to 6 weeks depending on the weather
- Material: Plastic

Ref. no.			€	100 % non-toxic
299851	1/20	600		



Fly Catcher Twister

- the glued paper strip is made from natural ingredients such as resins, oils and fats
- the free-hanging fly trap provides the perfect landing pad for flying insects
- use the red strap to carefully pull the rolled-up twister out of the lukewarm case and use the tacks provided to fasten to the ceiling
- Supplied with a display when purchasing 24 pieces.
- 4 piece / box

The classic one – 100 % non-toxic!

Ref. no.	MOQ	Pieces / unit			€
299839	1 pack	4 / pack	1/24/144	3.456	





Ultrasound Device Felix

• Modern and efficient system for keeping mice and rats away • Environmentally friendly and not harmful to either persons or pets • only mice and rats can hear the ultrasound, making them flee • Applications: closed stables, storehouses, offices, houses, wine cellars, restaurants, hotels, cafés etc. • suitable for indoor use



Technical data	29986
Voltage	220 - 230 V
Mains frequency	50 - 60 Hz
Power	10 - 30 W
Sound pressure level	96 - 110 dB
High frequency	22.000 - 28.000 Hz
Effective area	100 - 200 m ²
Effective area with 10 speakers	600 - 1.200 m ²
Housing material	metal

Ref. no.		€
29986	1/6	

Up to 10 external speakers can be connected to the device, with a single range of 80-100 m².

Ref. no.	Description		€
29987	Additional Speaker for Felix	1/18	

Mousetrap Luna

• with wooden shutter • 2 pieces on a tab card

Ref. no.	MOQ	Pieces / unit			€
299602	1 blister pack	2 / blister pack	1/50	4.500	

Original LUNA



Rat trap Luna

• with wooden shutter

Ref. no.	MOQ	Pieces / unit			€
299613	1 blister pack	1 / blister pack	1/30	2.160	

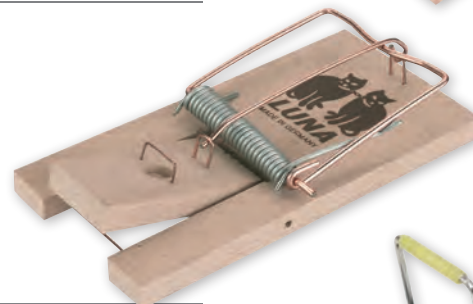

Mousetrap Snapper

• made of robust plastic

Ref. no.	Length	Width	MOQ	Pieces / unit			€
299826	11 cm	5 cm	1 blister pack	2 / blister pack	1/100	1.000	



Rat trap Snapper

• made of robust plastic

Ref. no.	Length	Width	MOQ	Pieces / unit			€
299834	14 cm	7,5 cm	1 blister pack	1 / blister pack	1/40	560	



Mousetrap mouseStop

- effective and ready-to-use mousetrap incl. special trigger
- used trigger can be replaced quick as a flash
- effective immediately after activation of the bait - simply remove the protective cap
- guaranteed trapping efficiency due to the calibrated punch of the trigger mechanism
- Material: Plastic
- 100 % non-toxic



• simple • safe • non-toxic



299822: For orders of 16 pieces, the delivery takes place in a representative counter display



Ref. no.	Description	MOQ	Pieces / unit			€
299822	in pairs	1 pack	2 / pack	1/16	1.440	
299823	in a stand display	44 pack	44 / display	1/44	880	

Ref. no.	Description	Material	MOQ	Pieces / unit		€
299824	Bait mouseStop	Plastic	1 blister pack	6 / blister pack	1/20/680	

Rat trap ratStop

- effective and ready-to-use rat trap incl. special trigger
- used trigger can be replaced quick as a flash
- effective immediately after activation of the bait - simply remove the protective cap
- guaranteed trapping efficiency through calibrated trigger mechanism
- Material: Plastic
- 100 % non-toxic



• simple • safe • non-toxic



299825: For orders of 12 pieces, the delivery takes place in a representative counter display



Ref. no.	Description	MOQ	Pieces / unit			€
299825	single	1 blister pack	1 / blister pack	1/12	696	
2998250	in a stand display	25 pieces	25 / display	1/25	500	

Ref. no.	Description	Material	MOQ	Pieces / unit		€
2998251	Bait ratStop	Plastic	1 blister pack	3 / blister pack	1/10/360	

Cage Mousetrap Alive

- with plastic base
- 2 entrances
- made from galvanised wire
- with opening flap
- no residues from previous catches, therefore higher catch rate



Ref. no.	Length	Width	Height			€
299617	15 cm	15 cm	7,5 cm	1/12/72	288	

Made in Germany



GEA

Infrared Heater

• Aluminium Screen ø 21 cm • with 6 air vents for better air circulation, extending the life of the infrared lamp • Fastening chain (max. 20 kg load capacity) • max. 175 W lighting source for equipment with economy switches! • E27

22318: in individual cardboard packaging

225280: in individual cardboard packaging



Top Seller

22291-S

2229-E

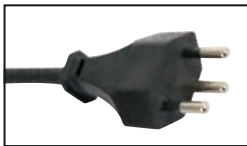

Ref. no.	Cable length	Switch type	Plug type	MOQ	Pieces / unit			€
2228	2,5 m		with Euro flat plug	2 pieces	2 / box	1/2	192	
22281	2,5 m	with economy switch	with Euro flat plug	2 pieces	2 / box	1/2	192	
2229	5 m		with Euro flat plug	2 pieces	2 / box	1/2	192	
22318	5 m		with Euro flat plug			1	96	
22291	5 m	with economy switch	with Euro flat plug	2 pieces	2 / box	1/2	192	
225280	5 m	with economy switch	with Euro flat plug			1	96	
2229-E	5 m		with British plug	2 pieces	2 / box	1/2	192	
22291-S	5 m	with economy switch	with Swiss plug	2 pieces	2 / box	1/2	192	

Ref. no.	Description		€
22296	Porcelain Socket for protective cage	1/15/300	

Philips Infrared Energy-Saving Lamp

• sturdy design thanks to moulded glass • Save up to 30 % on your energy costs now (compared to conventional infrared lamps) • This lamp stands out from the crowd thanks to its cost-effectiveness (average service life approx 5,000 hours), excellent heat transmission directed straight toward the animal, directly warming the surface of its skin. This ensures an optimum heat balance and boosts circulation in the tissues and muscle layers • universally usable e.g. poultry, piglets, veterinary therapy, drying processes for feed and food in agriculture • fits infra-red heater • splash-proof • Lamp Base: E27 • PAR 38 • Voltage: 230 V



Save up to 30 % on your energy costs!

Ref. no.	Colour	Power			€
22302	red	100 W	1/12	396	
22303	red	175 W	1/12	396	
22304	Clear	100 W	1/12	396	
22309	Clear	175 W	1/12	396	

PHILIPS

Digital thermometer for large animals

- with 14 cm-long probe • high precision • storage of the last value • Automatic shut-off
- waterproof • battery change display • operated with: 1 x 3 V - CR2032 Lithium-ion

Technical data	2138
Temperature measuring range	32 - 43,9 °C
Measuring time	8 sec
Temperature can be selected	Celsius °C / Fahrenheit °F
Temperature measurement accuracy	+/- 0,1 °C

Ref. no.		€	Ref. no.	Description		€
2138	1/6/24		29918	Button Battery 3 Volt	1/20	



Digital thermometer topTEMP

- Digital thermometer for rectal use for animals • ergonomically tailored to the animal
- operated with: 1 x 1.5 V - AAA (Micro) • Battery included

Technical data	21124
Temperature measuring range	32 - 42 °C
Measuring time	10 - 15 sec
Temperature can be selected	Celsius °C / Fahrenheit °F
Temperature measurement accuracy	+/- 0,1 °C
Weight	69 g

Ref. no.		€
21124	1/32	



Digital thermometer

- high precision • rapid measurement in 10 seconds (rectal) or 17 seconds (oral) • automatic audible signal at the end of measurement • storage of the last value • Automatic shut-off • each with transparent protective cover • waterproof • battery change display • operated with: 1 x 1.5 V - R41 Alkaline-manganese • Battery included

Technical data	
Temperature measuring range	32 - 42 °C
Temperature measurement accuracy	+/- 0,1 °C

Ref. no.	Description	Colour		€
2136	with rigid probe	purple	1/10/200	
2137	with flexible probe	orange	1/10/200	



Digital thermometer BigScreen

- with flexible probe • high precision • with indicator backlight: green - no fever, red - fever region • automatic audible signal at the end of measurement • storage of the last value
- Automatic shut-off • waterproof • battery change display • operated with: 1 x 3 V - CR2032 Lithium • Battery included

Technical data	2130
Temperature measuring range	32 - 43,9 °C
Measuring time	10 sec
Temperature can be selected	Celsius °C / Fahrenheit °F
Temperature measurement accuracy	+/- 0,1 °C

Ref. no.		€
2130	1/6/24	

Ref. no.	Description		€
29918	Button Battery 3 Volt	1/20	



Lamb Feeder Tray Multi Feeder

with portioning

New product

NEW

- with 5 portion compartments for the simultaneous provision of drinks to up to 5 lambs • with 5 Little Softy Teats (item no. 27120)
- makes animal surveillance easier during milk feeding • Volume per portion compartment: 3 litres • with rounded corners, thus very easy to clean • for hanging on barn walls, feed barriers, fences, etc.
- easy mounting and securing of the trough thanks to elastic straps
- stackable • easy to transport • food safe • acid-proof



Ref. no.	Capacity	Length	Width	Height		€
27700	30 L	81 cm	43 cm	38 cm	1	

27120

Ref. no.	Description	Colour	Length	Width	Height	Capacity	MOQ	Pieces / unit		€
14205	Drinking Trough Multi Feeder without teat	green	81 cm	43 cm	38 cm	30 L			1	
14142	Corner for Big Softy and Little Softy teats with valve	orange					1 pack	10 / pack	1	
14144	Corner for Big Softy and Little Softy teats without valve	white					1 pack	10 / pack	1	
14214	Cover for Multi Feeder	black							1/100	
27120	Teat Little Softy	white					25 pieces	25 / pack	1/25/250	
27120/5	Teat Little Softy	white					1 pouch	5 / pouch	1	

Lamb Bucket

- for feeding up to 6 lambs • with metal bracket for hanging on barn walls, feed barriers, fences, etc. • stackable • Material: Plastic • food safe • with metal carry handle

Included in delivery: 1 x lamb feeding bucket, 6 x teat (item 274), 6 x teat (item 275)



274

275



27500 + 324482



Ref. no.	Colour	Capacity	Watering places			€
27500	green	12 L	6	1	100	

Ref. no.	Description	Colour	MOQ	Pieces / unit		€
274	Teat	yellow	6 pieces	6 / pack	1/6/600	
274/6	Teat	yellow	1 blister pack	6 / blister pack	1	
275	Valve		6 pieces	6 / pouch	1/6/1.200	
275/6	Valve		1 blister pack	6 / blister pack	1	
324482	Cover for buckets and feeding bowls	black	1 pack	2 / pack	1/100	

Lamb Bucket

- for feeding up to 6 lambs • residue-free drainage thanks to angled base
- for hanging on barn walls, feed barriers, fences, etc. • stackable
- stable plastic • with metal carry handle

Included in delivery: 1 x lamb feeding bucket, 6 x teat (item 274), 6 x teat (item 275)



Ref. no.	Colour	Capacity	Watering places			€
27510	dark green	2 x 5 L	6	1/10	300	

Ref. no.	Description	Colour	MOQ	Pieces / unit		€
274	Teat	yellow	6 pieces	6 / pack	1/6/600	
274/6	Teat	yellow	1 blister pack	6 / blister pack	1	
275	Valve		6 pieces	6 / pouch	1/6/1.200	
275/6	Valve		1 blister pack	6 / blister pack	1	
324482	Cover for buckets and feeding bowls	black	1 pack	2 / pack	1/100	

Lamb Bucket

- for feeding up to 6 lambs • complete with retaining plate, teats and valves
- flattened on both sides • reinforced design • Supplies without cover
- Material: Plastic • food safe • with metal carry handle



Ref. no.	Colour	Capacity	Watering places			€
271	green	8 L	6	1	240	

Ref. no.	Description	Colour	Material	MOQ	Pieces / unit		€
274	Teat	yellow		6 pieces	6 / pack	1/6/600	
274/6	Teat	yellow		1 blister pack	6 / blister pack	1	
275	Valve			6 pieces	6 / pouch	1/6/1.200	
275/6	Valve			1 blister pack	6 / blister pack	1	
14211	Cover for Feeding Bucket simply	green				1/50	
1410	Mounting Bracket simply		metal galvanised	10 pieces	10 / pack	1/10/150	

Lamb Bucket

• complete with retaining plate, short, red teats and valves • Material: Plastic • food safe • with metal carry handle



Ref. no.	Description	Colour	Capacity	Watering places			€
276	with 5 red teats (item no. 277)	grey	8 L	5	1	240	
2769	with 3 red teats (item no. 277)	grey	8 L	3	1	240	

Ref. no.	Description	Colour	Material	MOQ	Pieces / unit		€
149	Screw Valve complete	grey	Plastic	10 pieces	10 / pack	1/10	
277	Teat	red		20 pieces	20 / pack	1/20/1.000	
2784	Teat	white		20 pieces	20 / pack	1/20/1.000	
27111	Teat	beige		20 pieces	20 / pack	1/20/800	
277/5	Teat	red		1 blister pack	5 / blister pack	1	
1410	Mounting Bracket simply		metal galvanised	10 pieces	10 / pack	1/10/150	

Lamb Bucket transparent

• fill level easy to see from a distance • complete with retaining plate, teats and valves
• flattened on both sides • food safe • with metal carry handle • with printed measurement scale, with additional embossed scale on the inside

New product

NEW





Ref. no.	Description	Colour	Capacity	Watering places			€
27512	with 6 teats	white transparent	8 L	6	1	240	
27513	with 5 short, red teats	white transparent	8 L	5	1	240	
27514	with 5 Little Softy Teats	white transparent	8 L	5	1		

Ref. no.	Description	Colour	Material	MOQ	Pieces / unit		€
149	Screw Valve complete	grey	Plastic	10 pieces	10 / pack	1/10	
274	Teat	yellow		6 pieces	6 / pack	1/6/600	
274/6	Teat	yellow		1 blister pack	6 / blister pack	1	
277	Teat	red		20 pieces	20 / pack	1/20/1.000	
277/5	Teat	red		1 blister pack	5 / blister pack	1	
1410	Mounting Bracket simply		metal galvanised	10 pieces	10 / pack	1/10/150	
27120	Teat Little Softy	white		25 pieces	25 / pack	1/25/250	
27120/5	Teat Little Softy	white		1 pouch	5 / pouch	1	

Lamb Bottle Anti-Vac

- complete with teat • special regulation of the flow rate • wide spout for easy filling • Material: Plastic • with printed measurement scale

Ref. no.	Colour	Capacity			€
278	transparent	450 ml	1/24/144	1.728	

Ref. no.	Description	MOQ	Pieces / unit		€
279	Teat for 278			1/50/1.000	
279/2	Teat for 278	1 blister pack	2 / blister pack	1/60	



Top Seller



279

Holder for lamb bottle



- for hanging on fences, pens, etc. • for 5 lamb bottles • suitable for Lamb Bottles Anti-Vac (item no. 278) • with plastic coating, making them very long-lasting • for hanging

Ref. no.	Colour			€
27110	dark green	1	36	



Lamb Bottle

- complete with teat • with hanging tab on the bottle base
- Material: Plastic • with embossed measuring scale

Ref. no.	Colour	Capacity			€
2780	white	1000 ml	1/20	320	

Ref. no.	Description	Colour	MOQ	Pieces / unit		€
277	Teat	red	20 pieces	20 / pack	1/20/1.000	
277/5	Teat	red	1 blister pack	5 / blister pack	1	



277

2780

Teat for lamb bottles

- Material: Natural rubber

Ref. no.	MOQ	Pieces / unit		€
2710	6 pieces	6 / pack	1/6/600	
2710/6	1 blister pack	6 / blister pack	1	



Bolt-On Bottle Nipple for lambs

- fits conventional bottle threads with an exterior diameter of 25 mm • mimics the natural shape of the mother's teat • special flutter valve ensures air flow when sucking • Material: Latex

New, improved quality with stronger rubber!

Ref. no.	Colour	MOQ	Pieces / unit		€
2783/5	red / yellow	1 pack	5 / pack	1/20/200	



Footbath Container SuperKombi Mini

for sheep

The SuperKombi Mini foot bath can be linked together successively and is ideal for hoof baths. Depending on the space available in the stable or field, this means you can create ideal situations for the animals. Consecutive baths are more hygienic: the first bath serves as a rinse to get rid of dirt and faecal residues from the hooves. The second bath, the treatment bath, thus remains free of dirt for longer, the disinfection solution remains usable for longer. The newly developed base profile ensures optimal traction. The animals go through the hoof bath more calmly, which promotes longer contact, achieving a better result. The shape and height of the profile ensure that the animal's hooves are slightly spread, allowing the hoof bath to reach areas between claws where it will be most effective more easily.

- can be flexibly expanded lengthwise
- high impact polyethylene for abrasion and chemical resistance
- suitable for use with all types of hoof bath solutions
- With gauge display



New product

NEW

16601

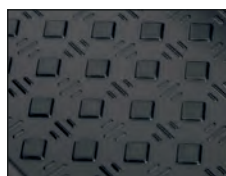

Base with special nub profile



Footbaths can be lined up one after another using the teeth provided



With gauge display

Ref. no.	Colour	Length	Width	Height	Capacity			€
16610	black	120 cm	40 cm	18 cm	50 L	1	40	

Ref. no.	Description		€
16601	Outlet for footbath / water trough	1/100	



Sheep Shearing Machine constanta4

- the tried-and-tested motor technology gives the constanta4 tremendous tractive power • even on matted and dirt-encrusted animals the constanta4 does not „yield“
- the blades glide through thickest wool without loss of performance
- special ventilation system with newly developed fan and new air duct produces substantially improved ventilation dynamics
- air filter can be replaced without tools
- Easy-to-service housing with ergonomic grip area for fatigue-free working
- Clipper blades made from tool steel with a special HRC hardening process have excellent durability with improved grinding properties and first-class cutting capacity

Included in delivery: 1 x sheep clippers constanta4, 1 x clipper blade set, 1 x small oil bottle, 1 x screwdriver, 1 x Durable plastic case



Made in Germany



Technical data	18993
Voltage	230 V AC
Mains frequency	50 - 60 Hz
Power	400 W
Stroke rate	approx. 2.400 strokes/min
Sound pressure level	87 dB
Cable length	3 m
Dimensions	35,5 x 8 x 10,8 cm
Weight	1.468 g without cable
Protection class	II

Ref. no.	Colour	Teeth lower/upper blade	Shearing type		€
18993	green	13 / 4	Sheep Shearing, very dirty animals	1/8	

Ref. no.	Description	Lower blade teeth	Upper blade teeth	MOQ	Pieces / unit		€
18931	Cutter head without clipper blade				1		
18978	Shearing blades Upper blade		4		1/50		
18988	Bottom blade	13			1/50		
18913	Shearing Blade Set	13	4	1 blister pack	1 / blister pack	1/50	

Shearing blades

• for cattle, llama and alpaca shearing with the sheep clipper



Ref. no.	Description	Upper blade teeth	Lower blade teeth	Shearing type		€
18534	Bottom blade		20	Cattle Shearing, very dirty animals	1/50	
18978	Upper blade	4		Alpaca Fleece, Lama Shearing, Cattle Shearing	1/50	

Sheep Shearing Machine FarmClipper Profi

Powerful shearing machine with steplessly adjustable speed. At maximum power, the FarmClipper reaches 350 Watt and 2400 rpm. The customisable setting options for each animal and its coat conditions mean a perfect shear every time. Thanks to the fitting of premium blades, the FarmClipper produces an extremely clean and even shearing pattern. The blades glide precisely through the coat, and even heavily soiled animals are shorn professionally, leaving behind no residual hair. The FarmClipper is also an ergonomic dream. The balanced centre of gravity ensures the continuous shearing of multiple animals without the shearer getting tired. The rubberised insert in the upper part of the housing ensures a safe and non-slip grip. As a result, the FarmClipper lies perfectly in the hand and its powerful motor means it can be used for long periods of time to produce professional shearing results.

Included in delivery: 1 x sheep clippers FarmClipper Profi, 1 x clipper blade set, 1 x small oil bottle, 1 x screwdriver, 1 x Durable plastic case



6-speed

Technical data	
Voltage	220 - 240 V
Mains frequency	50 Hz
Power	350 W
Stroke rate	approx. 2.400 strokes/min
Sound pressure level	87 dB
Cable length	5,5 m
Dimensions	33 x 7,8 x 9,7 cm
Weight	1.490 g without cable
Protection class	II

Ref. no.	Colour	Teeth lower/upper blade	Shearing type		€
18261	red / black	13 / 4	very dirty animals, Sheep Shearing	1/3	

Ref. no.	Description	Lower blade teeth	Upper blade teeth	MOQ	Pieces / unit		€
18140	Shearing blades Wellington Upper blade		4	1 blister pack	1 / blister pack	1/100	
18141	Shearing blades Wellington Bottom blade	13		1 blister pack	1 / blister pack	1/100	
18142	Shearing blades Wellington Clipper Blade Set (18140 + 18141)	13	4	1 blister pack	1 / blister pack	1/100	

Plant Protection Overall Typ 4

- spray tight chemical protection coverall CAT III, type 4B, 5B and 6B, suitable for use with pesticides
- infection protection against blood and viruses
- white with red, self-sealing zip fastener covers
- the inner spun-bonded fabric provides wearing comfort, the exterior is spray-tight polyethylene
- breathable but still impervious
- 3-piece hood
- thumb loops prevents the arms from riding up
- perfect fit due to an elastic strap on the arms, legs and waist
- corresponds to EN 13034:2005+A1:2009, EN ISO 13982-1:2004+A1:2010, EN 14605:2005+A1:2009, EN 1073-2:2002, EN 1149-5:2008, EN 14126:2003+AC:2004, EN 369, ISO 14644 classes ISO-7, ISO-8, ISO-9
- Areas of use: handling of agricultural chemicals, disease control, pest control, food industry, waste disposal, asbestos disposal, clean room use, etc.
- III



PPE Category III

Ref. no.	Colour	Size	Weight		€
34354	white / red	L	63 g/m ²	1/50	
34355	white / red	XL	63 g/m ²	1/50	
34356	white / red	XXL	63 g/m ²	1/50	



EN 14605: 2005+A1:2009



EN ISO 13982-1: 2004+A1:2010



EN 13034: 2005+A1:2009



EN 1073-2: 2002



EN 14126: 2003+AC:2004



EN 1149-5: 2008

Chemical protection overall CoverBase

- for protection from harmful dust and splashes of liquid chemicals
- 3-piece hood
- PPE Category III, particle tight, EN-13034-1
- limited splashproofing
- breathable
- with elastic in the hood for optimum fit and waist for optimum sitting conditions
- made of 3-layer SMS material (Spunbond/Meltblown/Spunbond)



New product

NEW

PPE Category III

Ref. no.	Colour	Size	Weight		€
34361	blue	L	55 g/m ²	1/50	
34362	blue	XL	55 g/m ²	1/50	
34363	blue	XXL	55 g/m ²	1/50	
34364	blue	XXXL	55 g/m ²	1/50	



EN ISO 13982-1: 2004+A1:2010



EN 13034: 2005+A1:2009



3427



3428



3408



3432

Disposable Coverall

- with long sleeves • non-sterile • Material: polyethylene

Ref. no.	Colour	Length	MOQ	Pieces / unit		€
3427	green	135 cm	1 pack	20 / pack	1/5	

Disposable Coverall

- with long sleeves • ideal for veterinaries • with press stud

Ref. no.	Colour	Length		€
3428	white	120 cm	1/50	

Disposable Coverall Basic

- protects against dust, dirt and splashes • with hood and zip fastener • elasticated arms, legs and waist • lightweight, soft and tear-resistant • with a zip fastener • Material: Polypropylene

Ref. no.	Colour	Size	Weight		€
3408	white	M	45 g/m ²	1/50	
3409	white	L	45 g/m ²	1/50	
3430	white	XL	45 g/m ²	1/50	
3431	white	XXL	45 g/m ²	1/50	
3479	white	XXXL	45 g/m ²	1/50	

Disposable Coverall

- protects against dust, dirt and splashes • with hood and zip fastener • elasticated arms, legs and waist • extra tear-resistant • with a zip fastener • Material: Polypropylene

Ref. no.	Colour	Size	Weight		€
3432	blue	L	55 g/m ²	1/50	
3433	blue	XL	55 g/m ²	1/50	
3434	blue	XXL	55 g/m ²	1/50	
3482	blue	XXXL	55 g/m ²	1/50	

Washing and Cleaning Overall with hood

- the durable fabric is waterproof, breathable and is ideal for harsh, continuous work in agriculture • with watertight taped seams • zip covering with extra button facing • with sealed elasticated band at the back • tightly-closing cuffs and double leg cuffs offer optimum protection from dirt and moisture • the overalls are meant to be worn in or over boots • hood with elastic in face area and hook and loop fastening behind the head for individual fitting according to body size • a protective strip sealed into the neck piece stops water from finding its way in • with suspension loop on the neck • with 2-way zip • washable at 30 °C

Composition

Textile 100 % Polyester

Ref. no.	Colour	Size		€
291243	dark blue	M	1/5	
291244	dark blue	L	1/5	
291245	dark blue	XL	1/5	
291246	dark blue	XXL	1/5	
291247	dark blue	XXXL	1/5	



Disposable overshoe

• with elastic • 0,07 mm • Material: polyethylene



Ref. no.	Description	Colour	Length	Height	MOQ	Pieces / unit		€
15375	tall design	white transparent	40 cm	50 cm	1 pack	100 / pack	1/5	
15360	half-height version	blue transparent	40 cm	29 cm	1 pack	100 / pack	1/5	

Disposable overshoe

• ankle high • with elastic • 0,035 mm • Material: polyethylene



Ref. no.	Colour	Length	Width	MOQ	Pieces / unit		€
15377	blue	41 cm	15 cm	1 pack	100 / pack	1/10	

Disposable Cap

• prevents the spread of germs • round shape (Ø 53 cm) • with elastic rubber strap • Material: Polypropylene fleece fabric



Ref. no.	Colour	MOQ	Pieces / unit		€
15378	light blue	1 pack	100 / pack	1/10	

Anti-Odour Cap

Protects your hair against odours!

• odour-inhibiting for stable odours, fatty odours, fire and smoke odours, sweat etc. • wind and weather-resistant
 • breathable and heat-regulating • maximum comfort • durable seams and improved fit through even more elastic cuffs. • also has sufficient space for long and voluminous hair • Material: Softshell and built-in anti-odour protection
 • breathable • washable at 30 °C



Composition	
Textile	80 % Polyester, 20 % polyurethane

Ref. no.	Colour	Size		€
15345	black	XXS / XS	1/20	
15346	black	S / M	1/20	
15347	black	L / XL	1/20	

Anti-Odour Headscarf

Protects your hair against odours!

• odour-inhibiting for stable odours, fatty odours, fire and smoke odours, sweat etc. • wind and weather-resistant
 • breathable and heat-regulating • maximum comfort • durable seams and improved fit through even more elastic cuffs. • also has sufficient space for long and voluminous hair • Material: Softshell and built-in anti-odour protection
 • breathable • washable at 30 °C



Composition	
Textile	80 % Polyester, 20 % polyurethane

Ref. no.	Colour	Size		€
15348	black	XS / S	1/20	
15349	black	M / L	1/20	
15350	black	XL	1/20	



Respirator FFP2 without valve

- effective against coarse dust, liquid droplets and droplet-borne infection
- no personal protective equipment (PPE)



Ref. no.	MOQ	Pieces / unit		€
34510/10	1 pouch	10 / pouch	1/20	

Fine dust mask FFP1 NR D

- protects up to 4 x the MAK value*
- protects against dust, pollen, rust, tile dust, aqueous aerosols
- EN149

Exhalation valve reduces the exhalation resistance, allowing moisture and heat to disperse more easily



* MAK value = maximum workplace concentration (limit)

Ref. no.	Description	Colour	MOQ	Pieces / unit		€
34511/3	without exhalation valve	white	1 blister pack	3 / blister pack	1/5/70	
34511/10	without exhalation valve	white	1 pouch	10 / pouch	1/50	
34512/3	with exhalation valve	white	1 blister pack	3 / blister pack	1/5/70	

34512/3

Fine dust mask FFP2 NR D

- protects up to 10 x the MAK value*
- protects against quartz, cement, flour and wood dust, metal smoke, fungal spores, aqueous solutions of herbicides
- EN149

Exhalation valve reduces the exhalation resistance, allowing moisture and heat to disperse more easily



34695/3

* MAK value = maximum workplace concentration (limit)

Ref. no.	Description	Colour	MOQ	Pieces / unit		€
34513	without exhalation valve	white	1 blister pack	1 / blister pack	1/5/70	
34695/3	with exhalation valve	white	1 blister pack	3 / blister pack	1/5/70	
34695/10	with exhalation valve	white	1 display	10 / display	1/12	

Protective Clothing and Equipment

Goggles

- with direct ventilation • Frame made from PVC, lenses made from polycarbonate • can be worn over regular spectacles • quick-fastening strap • Protects against drips and flying particles • EN166 Klasse B



Ref. no.	Colour	MOQ	Pieces / unit		€
34520	Clear	1 blister pack	1 / blister pack	1/20/60	

Eyewash

- sterile eye wash bottle with phosphate buffered rinse solution (4.9 %) • for chemical burns to the eye • high buffering capacity, especially gentle thanks to the exclusion of extraneous ingredients and preservatives • for mobile use or refilling stations and emergency kits with ergonomic eye bath and dust cap • Wash time: approx. 2.5 minutes • Shelf life: > 3 years • complies with DIN EN 15154-4



Ref. no.	Capacity		€
34534	250 ml	1/10/80	

Pesticide Set

complies with the Federal Office of Consumer Protection and Food Safety (BVL) 2017 guidelines

Personal protective equipment for dealing with pesticides, also suitable for transportation of dangerous goods (complies with the ADR guidelines).

set includes: 1 x tightly fitting pair of goggles as per EN 166 (item no. 34520), 1 pair of nitrile gloves size 10 / XL as per EN 374 (item no. 29825), 1 x 250 ml eye wash bottle with 4.9 % phosphate buffer solution as per EN 15154-4 (item no. 34534), 1 x half mask respirator ETNA, as per EN 149 (item no. 34535) with 1 pair of multigrade combination filters ABEK1P3, as per EN 14387 (item no. 34537), 1 x spray-proof disposable coverall size XXL type 4B, 5, 6 (CAT III), as per EN 14605 (item no. 34356), in a practical, dust-proof case 39 x 29 x 10.5 cm

New product

NEW





Ref. no.	Description			€
34507	Pesticide Set	1/10	160	



NORAMAX Safety S5

NORA PU safety boots with steel toe and steel midsole

- extremely lightweight, only 970 g • excellent comfort thanks to anatomic footbed and ergonomically shaped shaft • flexible at low temperatures and cold-insulating down to -20 °C • extremely durable due to new PU system by BASF – "ELASTOPAN"
- extremely anti-slip profile sole (SRC) through optimised profile geometry • self-cleaning profile outsole • NORA PU Insole Standard: extremely shock-absorbent, extremely moisture-absorbent • very good resistance to: animal fats, manure, blood, organic acids, alkalis, hydrocarbonate, alcohol • dirt-resistant, easy-clean surface • large, asymmetric comfort steel cap on 11 width base • Pull-out Aid • EN ISO 20345:2011 S5 CI HI SRC



Ref. no.	Colour	Size			€
347580	olive green	36	1/6	84	
347581	olive green	37	1/6	84	
347582	olive green	38	1/6	84	
347583	olive green	39	1/6	84	
347584	olive green	40	1/6	84	
347585	olive green	41	1/6	84	
347586	olive green	42	1/6	84	
347587	olive green	43	1/6	84	
347588	olive green	44	1/6	84	
347589	olive green	45	1/6	84	
347590	olive green	46	1/6	84	
347591	olive green	47	1/6	84	
347592	olive green	48	1/6	84	
347593	olive green	49	1/6	84	



NORAMAX Non Safety

NORA PU work boots without steel toe and steel midsole

- extremely lightweight, only 850 g • excellent comfort thanks to anatomic footbed and ergonomically shaped shaft
- flexible at low temperatures and cold-insulating down to -20 °C • extremely durable due to new PU system by BASF – "ELASTOPAN"
- extremely anti-slip profile sole (SRC) through optimised profile geometry • self-cleaning profile outsole
- Nora PU Insole Standard, extremely shock-absorbent, extremely moisture-absorbent • very good resistance to: animal fats, manure, blood, organic acids, alkalis, hydrocarbonate, alcohol • dirt-resistant, easy-clean surface • Pull-out Aid
- tested according to: EN ISO 20345:2011 CI SRC

Ref. no.	Colour	Size			€
347670	olive green	36	1/6	84	
347671	olive green	37	1/6	84	
347672	olive green	38	1/6	84	
347673	olive green	39	1/6	84	
347674	olive green	40	1/6	84	
347675	olive green	41	1/6	84	
347676	olive green	42	1/6	84	
347677	olive green	43	1/6	84	
347678	olive green	44	1/6	84	
347679	olive green	45	1/6	84	
347680	olive green	46	1/6	84	
347681	olive green	47	1/6	84	
347682	olive green	48	1/6	84	
347683	olive green	49	1/6	84	







NORATHERM S5

NORA PU thermal safety boots with steel toe and steel midsole

- extremely lightweight, only 1300 g • flexible at low temperatures and cold-insulating down to -50 °C • excellent comfort thanks to anatomic footbed and ergonomically shaped shaft • very good rolling movement thanks to the flexible shaft in the instep • extremely durable due to new PU system by BASF – “ELASTOPAN” • extremely anti-slip profile sole (SRC) through optimised profile geometry • self-cleaning profile outsole • NORA PU Insole Standard: extremely shock-absorbent, extremely moisture-absorbent • very good resistance to: animal fats, manure, blood, organic acids, alkalis, hydrocarbonate, alcohol • dirt-resistant, easy-clean surface • Pull-out Aid • tested according to: EN ISO 20345:2011.S5.CI.HI.SRC

Ref. no.	Colour	Size			€
347594	olive green	39	1/6	84	
347595	olive green	40	1/6	84	
347596	olive green	41	1/6	84	
347597	olive green	42	1/5	70	
347598	olive green	43	1/5	70	
347599	olive green	44	1/5	70	
347600	olive green	45	1/5	70	
347601	olive green	46	1/5	70	
347602	olive green	47	1/5	70	
347603	olive green	48	1/5	70	



New product

NEW

UNIK LOW S5

NORA Safety Canadian Boot

- PU galoshes, rubber sole: extremely durable thanks to new PU system by BASF – “ELASTOPAN” • Galoshes completely waterproof – water-resistant shaft – the ideal combination of the features of both shoes and boots
- extremely lightweight • 100 % metal-free – composite cap and Kevlar midsole • excellent comfort thanks to anatomic footbed and ergonomically shaped shaft • flexible at low temperatures and cold-insulating down to -20 °C • extremely anti-slip profile sole (SRC) through optimised profile geometry • self-cleaning profile outsole
- Insole: extremely shock-absorbent, extremely moisture-absorbent • very good resistance to: animal fats, manure, blood, organic acids, alkalis, hydrocarbonate, alcohol • dirt-resistant, easy-clean surface
- Pull-out Aid • tested according to: EN ISO 20345:2011 SH CI HI SRC

Ref. no.	Colour	Size		€
347658	black / grey	39	1/6	
347659	black / grey	40	1/6	
347660	black / grey	41	1/6	
347661	black / grey	42	1/6	
347662	black / grey	43	1/6	
347663	black / grey	44	1/6	
347664	black / grey	45	1/6	
347665	black / grey	46	1/6	
347666	black / grey	47	1/6	



New product

NEW

available from: Autumn 2020



NORA PU Clogs COMFY

A PU CLOG that does everything ... ideal for gardening and leisure, but also for work.

- flexible at low temperatures • extremely durable due to new PU system by BASF – “ELASTOPAN” • removable PU footbed with microfibre insole: shock-absorbent and antibacterial • washable • comfortable to wear • extremely lightweight • waterproof • very good resistance to: animal fats, manure, blood, organic acids, alkalis, hydrocarbonate, alcohol • profiled, self-cleaning outsole – very slip resistant

Ref. no.	Colour	Size			€
347632	olive green	36	1/5	280	
347633	olive green	37	1/5	280	
347634	olive green	38	1/5	280	
347635	olive green	39	1/5	280	
347636	olive green	40	1/5	280	
347637	olive green	41	1/5	230	
347638	olive green	42	1/5	230	
347639	olive green	43	1/5	230	
347640	olive green	44	1/5	230	
347641	olive green	45	1/5	180	
347642	olive green	46	1/5	180	
347643	olive green	47	1/5	180	
347644	olive green	48	1/5	180	



New product

NEW

NORA PU Insole Clog

- removable PU footbed • with antibacterial microfibre lining • shock-absorbent
- resistant to pressure-related deformation • washable



New product

NEW

	€
1/15	

Size	36	37	38	39	40	41	42	43	44	45	46	47	48
dark grey	347645	347646	347647	347648	347649	347650	347651	347652	347653	347654	347655	347656	347657

NORA PU Insole Safety Boots

Long-lasting cushioning

- very low compression rate of less than 5 %
- constant cushioning and fit inside the shoe

High-level breathability

- open cell PU foam has up to 100 % breathability
- Air can circulate into and around the insert, keeping the foot cooler inside the shoe
- Upper of antibacterial polyester

Moisture management

the open cell structure creates a moisture management system: Moisture is conveyed away from the foot, ensuring a cooler, drier and healthier shoe environment

Easy

NORA insoles are light and increase shoe effectiveness with airy comfort

	€
1/10	

Size	36	37	38	39	40	41	42	43	44	45	46	47	48	49
black	347604	347605	347606	347607	347608	347609	347610	347611	347612	347613	347614	347615	347616	347617



New product

NEW





More comfort – wider fit



More safety – higher steel cap



More skid resistance – optimised sole profile

Bekina Safety boot S5 Steplite® Easygrip

- made from ultra-lightweight polyurethane: 40 % lighter than rubber or PVC
- with steel cap and steel midsole
- supplied with anti-slip 3-layer inlay sole
- durable: lasts 3-4 x longer than PVC boots
- anti-slip and dirt-repellent sole
- resistant to manure, oil, petrol, grease, alkali and acid
- good heat and cold insulation down to - 20°C
- tested according to: EN ISO20345:2011.S5.SRC

NEOTANE®
TECHNOLOGY



You can find more information on NEO-TANE Technology at www.kerbl.de.

recommended by professional associations in Germany!

Ref. no.	Colour	Size			€
34140	olive green	36	1/5	80	
34141	olive green	37	1/5	80	
34142	olive green	38	1/5	80	
34143	olive green	39	1/5	80	
34144	olive green	40	1/5	80	
34145	olive green	41	1/5	80	
34146	olive green	42	1/5	80	
34147	olive green	43	1/5	80	
34148	olive green	44	1/5	80	
34149	olive green	45	1/5	80	
34150	olive green	46	1/5	80	
34151	olive green	47	1/5	80	
34152	olive green	48	1/5	80	



Bekina Safety boot S5 StepliteX® Solidgrip

- made from ultra-lightweight polyurethane: 40 % lighter than rubber or PVC
- durable: lasts 3-4 x longer than PVC boots
- more comfort: extra-wide and high fit
- more safety: higher steel bar and proven steel sole
- anti-slip and dirt-repellent sole
- resistant to manure, oil, petrol, grease, alkali and acid
- good heat and cold insulation down to - 30 °C
- supplied with shock-absorbing 2-layer footbed
- tested according to: EN ISO 20345:2011.S5.SRC

NEOTANE®
TECHNOLOGY



You can find more information on NEO-TANE Technology at www.kerbl.de.

according to S5 EN 345 and EN ISO 20345:2011.S5.SRC

Ref. no.	Colour	Size			€
3485	olive green	36	1/5	80	
3486	olive green	37	1/5	80	
3487	olive green	38	1/5	80	
3488	olive green	39	1/5	80	
3489	olive green	40	1/5	80	
3490	olive green	41	1/5	80	
3491	olive green	42	1/5	80	
3492	olive green	43	1/5	80	
3493	olive green	44	1/5	80	
3494	olive green	45	1/5	80	
3495	olive green	46	1/5	80	
3496	olive green	47	1/5	80	
3497	olive green	48	1/5	80	
3498	olive green	49	1/5	80	



stepliteX®



More comfort – wider fit



More safety – higher steel cap



More skid resistance – optimised sole profile

Bekina Safety boot S5 StepliteX® Thermoprotec

- ultra-lightweight, but no less secure, thanks to metal-free toe protection and sole
- upper material made from foamed polyurethane
- dirt-repellent and anti-slip sole profile
- excellent insulation performance - cool in summer, warm in winter (down to -40 °C)
- Supplied with shock-absorbing 2-layer footbed
- oil resistant, Petrol-resistant, acid-proof
- tested according to: EN ISO 20345:2011.S5.SRC

NEOTANE®
TECHNOLOGY



You can find more information on NEOTANE Technology at www.kerbl.de.

Steplite® XCI is the ideal combination for a summer and winter boot. Experience the wearing comfort of a summer boot enhanced with the thermal properties of a winter boot.

Ref. no.	Colour	Size			€
34341	olive green	37	1/4	64	
34342	olive green	38	1/4	64	
34343	olive green	39	1/4	64	
34344	olive green	40	1/4	64	
34345	olive green	41	1/4	64	
34346	olive green	42	1/4	64	
34347	olive green	43	1/4	64	
34348	olive green	44	1/4	64	
34349	olive green	45	1/4	64	
34350	olive green	46	1/4	64	
34351	olive green	47	1/4	64	
34352	olive green	48	1/4	64	



Bekina Safety boot S5 Thermolite® Iceshield

- with insulation to -50 °C, the Thermolite shows its strengths wherever the wearer is exposed to adverse weather conditions
- excellent service life thanks to silky PU material
- maximum wearing comfort and resilience thanks to thick shaft and extra-thick sole
- dirt-repellent and anti-slip sole profile
- supplied with shock-absorbing 2-layer footbed
- integrated steel cap
- made from polyurethane
- tested according to: EN ISO 20345:2011.S4.SRC

NEOTANE®
TECHNOLOGY



You can find more information on NEOTANE Technology at www.kerbl.de.

insulated to -50 °C
10 % lighter than comparable polyurethane boots
Conversion to S5 during the year 2020

Ref. no.	Colour	Size			€
3470	olive green	39	1/4	64	
3471	olive green	40	1/4	64	
3472	olive green	41	1/4	64	
3473	olive green	42	1/4	64	
3474	olive green	43	1/4	64	
3475	olive green	44	1/4	64	
3476	olive green	45	1/4	64	
3477	olive green	46	1/4	32	
3478	olive green	47	1/4	64	





More comfort – wider fit



More safety – higher steel cap



More skid resistance – optimised sole profile

2-layer Footbed

- ergonomically shaped footbed for even greater comfort inside the boot and better ventilation
- anti-bacterial treatment • shock-absorbing reinforcement of the heel • improved breathability
- suitable for all BEKINA® boots • washable at 30 °C



	€
1/40	

Size	36	37	38	39	40	41	42	43	44	45	46	47	48	49
green	34106	34107	34108	34109	34110	34111	34112	34113	34114	34115	34116	34117	34118	34119

3-layer Inlay Sole

- excellent insulation thanks to additional felt upper layer • felt layer is odour-absorbing
- padding effect across the whole of the base of the foot • excellent slip resistance thanks to rubberised sole • suitable for all BEKINA® boots • washable at 30 °C



	€
1/40	

Size	36	37	38	39	40	41	42	43	44	45	46	47	48
green	34174	34175	34176	34177	34178	34179	34180	34181	34182	34183	34184	34185	34186

Boot Cleaner

- for standing • non-slip • complete with 5 brushes and grate • sturdy stainless steel design • easy cleaning with water • the application of cleaning agents prevents the introduction of pathogens into the stables



Ref. no.	Connection			€
29320	1/2"	1	25	

Ref. no.	Description		€
29321	Floor Brush	1/10	
29322	Side Brush top	1	
29323	Side Brush below	1/10	



Dunlop® Safety boot Purofort® S5

- Toe protection: Steel cap • Perforation protection: Steel midsole • upper material made from foamed polyurethane • reflectors for increased safety • Dunlop red inner lining made from antibacterial material • anti-slip, dirt-repellent PU profile sole
- midsole with improved comfort and durability • wide profile for all surface types
- Purofort® material technology ensures temperature insulation to -20 °C • limited resistance to oil, petrol and acid • anti-static • ideal for use in agriculture • tested according to: EN ISO 20345:2011.S5.CI.SRA



Top Seller



Inner lining made from anti-bacterial material

Ref. no.	Colour	Size			€
34750	olive green	37	1/6	108	
34751	olive green	38	1/6	108	
34752	olive green	39	1/6	108	
34753	olive green	40	1/6	108	
34754	olive green	41	1/6	108	
34755	olive green	42	1/6	108	
34756	olive green	43	1/6	72	
34757	olive green	44	1/6	72	
34758	olive green	45	1/6	72	
34759	olive green	46	1/6	72	
34760	olive green	47	1/6	72	
34761	olive green	48	1/6	72	

Dunlop® Safety boot Purofort®+ S5

- extra room in the toe area • anatomically shaped footbed • upper material made from foamed polyurethane • Dunlop red inner lining made from antibacterial material • anatomically shaped Premium inner sole • anti-slip, dirt-repellent, easy-to-clean PU profile sole with ladder rung protection • anti-static • limited resistance to oil, petrol and acid • Purofort® material technology ensures temperature insulation to -20 °C • easy-to-clean profile - ideal for use in agriculture
- Toe protection: Steel cap • Perforation protection: Steel midsole • tested according to: EN ISO 20345:2011.S5.CI.SRC



Inner lining made from anti-bacterial material

Ref. no.	Colour	Size			€
34770	olive green	36	1/6	72	
34771	olive green	37	1/6	108	
34772	olive green	38	1/6	108	
34773	olive green	39	1/6	108	
34774	olive green	40	1/6	108	
34775	olive green	41	1/6	108	
34776	olive green	42	1/6	108	
34777	olive green	43	1/6	72	
34778	olive green	44	1/6	72	
34779	olive green	45	1/6	72	
34780	olive green	46	1/6	72	
34781	olive green	47	1/6	72	
34782	olive green	48	1/6	72	
34783	olive green	49 / 50	1/6	72	







Dunlop® Safety boot Purofort® Thermo+ S5

• Toe protection: Steel cap • Perforation protection: Steel midsole • upper material made from foamed polyurethane • Dunlop red inner lining made from antibacterial material • anatomically shaped Premium inner sole • anti-slip, dirt-repellent PU profile sole • anti-static • limited resistance to oil, petrol and acid • ideal for use on dairy farms • with insulation to - 50 °C, the Thermo+ shows its strengths wherever the wearer is exposed to adverse weather conditions • ideal for work in cold weather conditions, including for livestock farmers. The thick sole prevents the foot from cooling down, while the particularly low profile is especially suitable for wet areas • shock-absorbent and extremely hard-wearing • tested according to: EN ISO 20345:2011.S5.CI.SRC





Inner lining made from anti-bacterial material

Ref. no.	Colour	Size			€
34880	olive green	37 / 38	1/6	60	
34881	olive green	39 / 40	1/6	60	
34882	olive green	41	1/6	60	
34883	olive green	42	1/5	60	
34884	olive green	43	1/5	60	
34885	olive green	44 / 45	1/5	60	
34886	olive green	46	1/5	60	
34887	olive green	47	1/5	60	
34888	olive green	48	1/5	60	

Dunlop® Work Boots Pricemaster

• classic, highly waterproof PVC boots for work, garden and leisure • inner lining made from easy-care polyester • black shaft, black sole • conditionally resistant to oils, acids, fertilisers, disinfectants and various chemicals • CE approved



Ref. no.	Colour	Size			€
34785	black	37	1/8	240	
34786	black	38	1/8	192	
34787	black	39	1/8	192	
34788	black	40	1/8	192	
34789	black	41	1/8	192	
34790	black	42	1/8	192	
34791	black	43	1/8	192	
34792	black	44	1/8	192	
34793	black	45	1/8	144	
34794	black	46	1/8	144	
34795	black	47	1/8	144	



Dunlop® Work Boots Dee

• half-height waterproof PVC boots for work, garden and leisure • shaft height approx. 26 cm • dark green shaft, black sole • conditionally resistant to oils, acids, fertilisers, disinfectants and various chemicals • with Dunlop® profile sole • inner lining made from easy-care polyester



extra low shaft height approx. 26 cm

Ref. no.	Colour	Size			€
34951	olive green	37	1/10	240	
34952	olive green	38	1/10	240	
34953	olive green	39	1/10	240	
34954	olive green	40	1/10	240	
34955	olive green	41	1/10	240	
34956	olive green	42	1/10	240	
34957	olive green	43	1/10	240	
34958	olive green	44	1/10	240	
34959	olive green	45	1/10	180	
34960	olive green	46	1/10	180	
34961	olive green	47	1/10	180	

Dunlop® Winter Boots Blizzard

• attractive design and comfortable feel when wearing • thick, comfortable inner lining made from synthetic fleece • PVC upper and sole • excellent insulation against cold • colour-accentuated, shock-absorbing midsole • waterproof laced cuff • outer sole with particularly good grip

Ref. no.	Colour	Size			€
34850	olive green / black	36	1/6	72	
34851	olive green / black	37	1/6	72	
34852	olive green / black	38	1/6	72	
34853	olive green / black	39	1/6	54	
34854	olive green / black	40	1/6	54	
34855	olive green / black	41	1/6	54	
34856	olive green / black	42	1/6	54	
34857	olive green / black	43	1/6	54	
34858	olive green / black	44	1/6	54	
34859	olive green / black	45	1/6	54	
34860	olive green / black	46	1/6	54	
34861	olive green / black	47	1/6	54	
34862	olive green / black	48	1/6	54	



Dunlop® Inlay sole Basic

suitable for Purofort® S5

- absorption: the new inlay soles can absorb up to 3 times more moisture than their own sole weight
- double improvement in energy-absorbing properties
- 30 % better odour control
- maintain their shape better while being put on and taken off, and remain in the boot
- made from Polyurethane®, a PU component, which makes them the perfect match for Dunlop Purofort boots



€	Size	37	38	39	40	41	42	43	44	45	46	47	48
1/10	black	34910	34911	34912	34913	34914	34915	34916	34917	34918	34919	34920	34921

Dunlop® Inlay sole Premium

suitable for Purofort®+ S5 and Purofort® Thermo+ S5

- absorption: the new inlay soles can absorb up to 3 times more moisture than their own sole weight
- double improvement in energy-absorbing properties
- 30 % better odour control
- maintain their shape better while being put on and taken off, and remain in the boot
- made from Polyurethane®, a PU component, which makes them the perfect match for Dunlop Purofort boots
- ergonomically shaped footbed with 3-zone cushioning for even greater comfort inside the boot
- improved breathability thanks to „ventilation channels“ in the toe area



€	Size	37	38	39	40	41	42	43	44	45	46	47	48	49 / 50
1/10	black	34891	34892	34893	34894	34895	34896	34897	34898	34899	34900	34901	34902	34903

Dunlop® Snugboot Pioneer

Developed for more comfort for people who go their own way.

- the PUROTEX material creates the first breathable and waterproof boot shaft
- PUROFORT Flexzone makes it easy to put on and take off
- lightweight, wear-resistant upper for comfort from dawn to dusk
- SRC-certified, anti-slip outer sole so you can truly master any terrain
- abrasion-resistant and easy-clean outer sole
- the stable fit envelops your foot and ensures biomechanical support at every step
- precision-developed snug fit
- lightweight Purofort® material for long-lasting comfort
- puortex's breathability and absorption capacity means no sweaty feet





Ref. no.	Colour	Size	€
347550	black	37	60
347551	black	38	96
347552	black	39 / 40	60
347553	black	41	60
347554	black	42	60
347555	black	43	50
347556	black	44 / 45	50
347557	black	46	50
347558	black	47	50
347559	black	48	50

Dunlop® Snugboot WorkPro Full Safety

Designed for more comfort for those who know how to do things.

- the PUROTEX material creates the first breathable and waterproof boot shaft
- lightweight, wear-resistant upper for comfort from dawn to dusk
- high-quality Purofort® material for maximum safety
- SRC-certified, anti-slip outer sole so you can truly master any terrain
- abrasion-resistant and easy-clean outer sole
- the stable fit envelops your foot and ensures biomechanical support at every step
- lightweight metal-free toe cap and midsole
- lightweight Purofort® material for long-lasting comfort
- certified in accordance with all the world's major safety standards
- tested according to: EN ISO 20345:2011 S5 CI CR SRC | CSA Z195-14 PR SD | ASTM F2413-17 M I/75 C/75 PR SD 100



Ref. no.	Colour	Size			€
347560	black	37	1/6	60	
347561	black	38	1/6	60	
347562	black	39 / 40	1/6	60	
347563	black	41	1/6	60	
347564	black	42	1/6	60	
347565	black	43	1/5	50	
347566	black	44 / 45	1/5	50	
347567	black	46	1/5	50	
347568	black	47	1/5	50	
347569	black	48	1/5	50	



Dunlop® Snugboot Wildlander

Designed for more comfort for those who are at home outside.

- the PUROTEX material creates the first breathable and waterproof boot shaft
- (odourless) anti-microbial lining with Mossy Oak Break-Up-Country pattern
- wear-resistant for all outdoor activities
- SRC-certified, anti-slip outer sole so you can truly master any terrain
- abrasion-resistant and easy-clean outer sole
- the stable fit envelops your foot and ensures biomechanical support at every step
- precision-developed snug fit
- lightweight Purofort® material for long-lasting comfort
- puortex's breathability and absorption capacity means no sweaty feet

Ref. no.	Colour	Size			€
347570	brown	37	1/6	60	
347571	brown	38	1/6	60	
347572	brown	39 / 40	1/6	60	
347573	brown	41	1/6	60	
347574	brown	42	1/6	60	
347575	brown	43	1/5	50	
347576	brown	44 / 45	1/5	50	
347577	brown	46	1/5	50	
347578	brown	47	1/5	50	
347579	brown	48	1/5	50	



GEA



Boots NeoLite

- ideal for working in stalls or pastures • 100 % watertight • sole with self-cleaning profile for a high level of slip resistance • the heat insulating properties of synthetic rubber also keep feet pleasantly warm in winter • the low weight and flexible shaft made from synthetic rubber provide an extremely high level of wearing comfort



New sizes available from: April 2020

Composition	
Shaft	100 % synthetic rubber
Insole	100 % PVC
Base	100 % PVC

Ref. no.	Colour	Size		€	
322071	black	36	1/10		
322072	black	37	1/10		
322073	black	38	1/10		
322074	black	39	1/10		
322075	black	40	1/10		
322076	black	41	1/10		
3222071	black	42	1/10		
3222072	black	43	1/10		NEW
3222073	black	44	1/10		NEW
3222074	black	45	1/10		NEW

Boots NeoLite

mid high

- ideal for working in stalls or pastures • 100 % watertight • sole with self-cleaning profile for a high level of slip resistance • the heat insulating properties of synthetic rubber also keep feet pleasantly warm in winter • the low weight and flexible shaft made from synthetic rubber provide an extremely high level of wearing comfort



New sizes available from: April 2020

Composition	
Shaft	100 % synthetic rubber
Insole	100 % PVC
Base	100 % PVC

Ref. no.	Colour	Size		€	
3210190	black	36	1/10		
3210191	black	37	1/10		
3210192	black	38	1/10		
3210193	black	39	1/10		
3210194	black	40	1/10		
3210195	black	41	1/10		
3222098	black	42	1/10		NEW
3222099	black	43	1/10		NEW
3222100	black	44	1/10		NEW
3222101	black	45	1/10		NEW



Glove Premium Plus

- elastic, seamless Nylon fabric (15 gauge) for a perfect fit with any hand shape, good mobility
- thin, breathable nitrile foam coating for excellent protection against mechanical hazards, oil and water-repellent
- secure grip especially in dry conditions because of dotted palm
- band in various colours according to size
- solvent free (DMF)



Evaluation	
Durability	••••
Dexterity	••••
Moisture protection	••
Resistant to oil/grease	•••
Slip-resistance	••••
Breathability	••••

with presentation tag

Ref. no.	Colour	Glove Size		€
297971	bordeaux	7 / S	1/6/144	
297972	bordeaux	8 / M	1/6/144	
297973	bordeaux	9 / L	1/6/144	
297974	bordeaux	10 / XL	1/6/144	
297975	bordeaux	11 / XXL	1/6/144	
297976	bordeaux	12 / XXXL	1/6/144	



Top Seller

EN 388:2016



4121 X



Finely knitted glove SmoothGrip

- fine-knit glove made from polyester (13 gauge)
- with soft latex foam coating
- with good grip properties
- back of hands and fingers free
- perfect fit for high sensitivity
- breathable, with good grip
- Usage: assembly, repairs, universal uses
- EN 388, CAT II



Evaluation	
Durability	•••
Dexterity	•••
Moisture protection	•
Resistant to oil/grease	•
Slip-resistance	•••
Breathability	•••

EN 388:2016



2131 X

with barcode tag

Ref. no.	Colour	Glove Size	MOQ	Pair / VE		€
297572	red	8 / M	6 pair	6 / pack	1/6/60	
297573	red	9 / L	6 pair	6 / pack	1/6/60	
297574	red	10 / XL	6 pair	6 / pack	1/6/60	
297575	red	11 / XXL	6 pair	6 / pack	1/6/60	



Finely knitted glove ActivGrip XA325

• fine-knit glove made from polyester / cotton (13 gauge) • double-dipped in latex, making them more abrasion-resistant than regular latex gloves • Open back, thumb fully covered • Palm with "MicroFinish" (the surface structure is similar to suction cups making it especially anti-slip) • excellent fingertip sensitivity and perfect fit • washed, thus protection against latex allergies



with presentation tag

Ref. no.	Colour	Glove Size		€
297671	orange / grey	7 / S	1/6/144	
297672	orange / grey	8 / M	1/6/144	
297673	orange / grey	9 / L	1/6/144	
297674	orange / grey	10 / XL	1/6/144	
297675	orange / grey	11 / XXL	1/6/144	

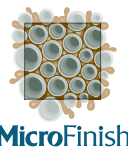

Evaluation	
Durability	• • •
Dexterity	• • • •
Moisture protection	• • • •
Resistant to oil/grease	•
Slip-resistance	• • • • •
Breathability	• • •



Finely knitted glove ActivGrip Advance

• seamless fine-knit nylon glove (13 gauge) • high quality nitrile coating, very good mechanical properties (abrasion), oil-resistant • „MicroFinish“ (surface structure is similar to suction cups), especially good grip, even in dry, damp or oily conditions • elastic Nylon fabric ensures a perfect fit and pleasant climate, glove is like a second skin • universal use



with presentation tag

Ref. no.	Colour	Glove Size	MOQ	Pair / VE		€
297290	purple	6 / XS	6 pair	6 / pack	1/6/144	
297291	purple	7 / S	6 pair	6 / pack	1/6/144	
297292	purple	8 / M	6 pair	6 / pack	1/6/144	
297293	purple	9 / L	6 pair	6 / pack	1/6/144	
297294	purple	10 / XL	6 pair	6 / pack	1/6/144	
297295	purple	11 / XXL	6 pair	6 / pack	1/6/144	



Evaluation	
Durability	• • • • •
Dexterity	• • • •
Moisture protection	• • •
Resistant to oil/grease	• • • •
Slip-resistance	• • • • •
Breathability	• • • •



Full Cowhide Glove YELLTOR Yelltor

• leather thickness approx 1.1 mm • large cut • semi-lined • professional quality



Evaluation	
Durability	••••
Dexterity	••
Moisture protection	•••
Resistant to oil/grease	••
Slip-resistance	•••
Breathability	•••

EN 388:2016



1132 X



with barcode tag

Ref. no.	Colour	Glove Size		€
29748	yellow	10 / XL	1/6/60	
29749	yellow	11 / XXL	1/6/60	



Chemicals Glove Chemex

- liquid-tight chemical glove with a strong nitrile coating (0.85 mm) • cotton liner • resistant to many aggressive chemicals such as n-heptane, sodium hydroxide solution (40 %) or sulphuric acid (96 %) • excellent abrasion resistance • surface for good grip in both dry and wet conditions
- Areas of use: farming, mechanical engineering, oil industry, paintshops



Evaluation	
Durability	•••••
Dexterity	••
Moisture protection	•••••
Resistant to oil/grease	•••••
Slip-resistance	••••
Breathability	

particularly suitable for handling chemicals!

EN 388:2016



4011 X

EN ISO 374-1:2016
Type A



AJKLMNOPT

EN ISO 374-5:2016



Ref. no.	Colour	Glove Size		€
297646	green	8 / M	1/6/60	
297647	green	9 / L	1/6/60	
297648	green	10 / XL	1/6/60	
297649	green	11 / XXL	1/6/60	

with presentation tag



Winter Glove IceGrip

- seamless fine-knit glove made from polyester/cotton • fluorescent
- with warm acrylic lining • elastic latex foam coating • Areas of use: construction, industrial freezers and outdoor work



Evaluation	
Durability	•••
Dexterity	•••
Moisture protection	•••
Resistant to oil/grease	•
Slip-resistance	••••
Breathability	•••
Winter	••••

EN 388:2016



3241 X

with barcode tag

Ref. no.	Colour	Glove Size		€
297481	orange	7 / S	1/6/60	
297482	orange	8 / M	1/6/60	
297483	orange	9 / L	1/6/60	
297484	orange	10 / XL	1/6/60	
297485	orange	11 / XXL	1/6/60	



I			
IceCool Cooling Spray	97	Milker Apron	13
IceGrip Winter Glove	230	Milking and washing apron	79, 80
Indicator Paper	69	Milking and washing apron MaxiMove	80
Infrared Energy-Saving Lamp	201	Milking Fat	72
Infrared Heater	201	Milking Machine Oil Viscano	91
Inlay sole Basic	224	Milking Pail	14, 90
Inlay sole Premium	224	Milking Pail Lid	91
Insect Killers 2138	193	Milking Pail Stainless Steel	90
Insect Killers EcoKill	195	Milking Sealing Plug	89
Insect Killers EcoKill Inox	194	Milking Stool	89
Insect Killers EcoKill Inox IPX4	195	MilkPot 50 Milk warmer	39
Insect Killers Green Line	193	MilkyDrencher Calf Drencher	36
Installation plate	155	MilkyFeeder Calf Bottle	35
Introducer	64, 102	MilkyTeat Calf Teat	33
IPCam 2.0 HD	19	Mineral Lick Equisal NoFly	140
IPCam 360 FHD	18	Mobile LED Battery Spotlight	
IPCam 360 FHD mini	19	WorkFire Pro	192
		Mobile LED Battery Spotlight	
J		WorkFire Pro 30	191
Jumbo All-Purpose Bucket	173	Mod. 221500 Water Bowl	148
JumboXL Fly roll	197	Mod. 222000 Water Bowl	149
		Modell A 800 Bayern SECURPART	
K		Calf Puller	23
K75 Water Bowl	147	Modular fence stabling	54
Ket-o-Vital® Bolus	62	Moisture Meter	181
Kick Stop Amerika	101	Moisture-proof diffuser light	188
KN50 Water Bowl	153, 154	Mounting Bracket	31
Komfort Spray Rinser	78	Mounting Set	57
Kompakt Large broom	171	mouseStop Mousetrap	200
		Mousetrap Luna	199
L		Mousetrap mouseStop	200
Lamb Bottle	206	Mousetrap Snapper	199
Lamb Bottle Anti-Vac	206	Muck and Slurry Pusher	174, 175
Lamb Bucket	203, 204, 205	Müller 2010 Cattle Weaner	98
Lamb Feeder Tray Multi Feeder	203	Müller Cattle Weaner	98
Large broom	171, 172	Multi Feeder Calf Feeder Tray	32
Large broom Kompakt	171	Multi Feeder Drinking Trough	32
Large scrubber	84	Multi Feeder Lamb Feeder Tray	203
LED Floodlight	192	MultiLED pro	185
LED Indoor Spotlight	184	Multipurpose Grease Viscano	170
LED Lighting Control	186		
LED moisture-proof lamp	189	N	
LED moisture-proof lamp FarmPRO	189	N20 Water Bowl	154
LED moisture-proof lamp FarmSTAR	188	NeoLite Boots	226
LED Outdoor Spotlight	190	Nirosta Snow Broom	34
LED Oval Light	191	Nitril Disposable glove	12
LED Tube EcoTUBE	187	Nitrile Basic Disposable glove	83
LED Tube EcoTUBE Plus	187	Nitrile Classic Disposable glove	83
Leg band numbers	137	Nitrile Long Black Disposable glove	82
Leimer Teat	34	Nitrile Premium Disposable glove	82
Lick holder	140	Nitrile Profi Disposable glove	82
Litter fork	180	Non-Return Dip Cup	71
Lubricating Gel VetGel	25	NonReturn Cross Dip Cup	10
Luna Mousetrap	199	NonReturn Dip Cup	10
Luna Rat trap	199	NonReturn Twin Dip Cup	10
		NORAMAX Non Safety	215
M		NORAMAX Safety S5	215
Manure Scraper	174	NORATHERM S5	216
Marking collar	139	Numbering block	138
Marking Spray TopMarker	135	Numbering block Standard	137
Master Plus CalfHouse	49		
Mastitis Tester	69	O	
MaxiMove Milking and washing apron	80	orig. Gilmour Spray Shower	78
Measuring cup	92	Outlet Raimo BigBag	182
Metal Curry Comb	122	Oxford Protective Sleeve	81
Milk and Cheese Thermometer	92		
Milk Bottle	35	P	
Milk dummy cap	89	P6 Hoof Cutting Disc	107
Milk Filter Sock	6, 7	Paper Towel Roll	75
Milk Filters Premium	88	Pasture Panel	145, 146
Milk heater for calf feeding	42	Pesticide Set	214
Milk heater for calf feeding EasyHeat	41	Phosphogol Bolus	62
Milk heater for calf feeding FastHeat	41	Pipe Brush	85
Milk heater for calf feeding		Plant Protection Overall Typ 4	210
FastHeat Digital	40	Plug Rope	59
Milk measuring device	93	Plug	142
Milk Sieve	88	Portasol 3 Gas Dehorner	96
Milk Tube Cleaning Sponge	8	PortaSpray Dip Sprayer	11
Milk warmer MilkPot 50	39	Power Dispenser	121
		Power Tail Trimmer II	87
		Pre-milk Cup	69
		Pre-milk Cup Ambic	69
		Precision Adjusting Aid Torqui	128
		Pregnancy Tester	24
		Premium Inlay sole	224
		Premium Milk Filters	88
		Premium Plus CalfHouse	47
		Premium Plus Glove	227
		Premium Shearing Blade Set	131
		Premium Squeegee	176
		Premium Supplies Set	4
		PREVENTA Udder Hair Remover	87
		Pricemastor Work Boots	222
		Profi Aluminium Shovel	178
		Profi Barrel Pump	76
		Profi Calf Drencher	36
		Profi Cow Lifting Frame	27
		Profi Dispensing Pump	76
		Profi Hoof and claw knife	109
		Profi Special Aluminium Shovel	178
		ProfilacDermacel Udder Paper	9
		ProfilacDermatex Udder Cloth	9
		Prolapse Bandage	26
		ProStream Teat Spraying System	11
		Protective Sleeve	13, 81
		Protective Sleeve Oxford	81
		Protective Sleeve Softshell	81
		ProTrim Hoof Cutting Disc	107
		PU Clogs COMFY	217
		PU Insole Clog	217
		PU Insole Safety Boots	217
		Purofort® S5 Safety boot	221
		Purofort® Thermo+ S5 Safety boot	222
		Purofort®+ S5 Safety boot	221
		Q	
		Quarter milker	93
		R	
		Raimo BigBag Outlet	182
		Rain Gauge	169
		Rat trap Luna	199
		Rat trap ratStop	200
		Rat trap Snapper	199
		ratStop Rat trap	200
		Rectangular Trough	142
		Refractometer	29
		Respirator FFP2	213
		Rinser Anka	77
		Rinser Super Jet	77
		Rinser Twist Jet	77
		Ripstopp Calf blanket	61
		Rod thermometer	92
		Roll	198
		Round hay rack	144
		Round Trough	142
		Round-headed brush	84
		Rubber wiper	176
		Ruminal Magnet	102
		Ruminal Magnet forte	102
		Ruminal Magnet fortissimo	102
		S	
		S1090 Float Bowl	151
		S190 Float Bowl	150
		S195 Float Bowl	150
		S5 StepliteX® Solidgrip Safety boot	218
		S5 StepliteX® Thermoprotect Safety boot	219
		S5 Steplite® Easygrip Safety boot	218
		S5 Thermolite® Iceshield Safety boot	219
		S522 Float Bowl	149
		S60 Double Float Drinking Bowl	154
		Safety boot Purofort® S5	221
		Safety boot Purofort® Thermo+ S5	222
		Safety boot Purofort®+ S5	221
		Safety boot S5 StepliteX® Solidgrip	218
		Safety boot S5 StepliteX® Thermoprotect	219
		Safety boot S5 Steplite® Easygrip	218
		Safety boot S5 Thermolite® Iceshield	219
		Salt Lick	140
		SalvoCare Mint Udder Care Products	14
		schalm test disk	69
		Scratch Brush	58, 126
		Scratch Brush HAPPYCOW MiniSwing	126
		Scratch Mat	58, 127
		Screw Valve	31
		Scrubber	172
		sealing ring	31
		SECURPART Calf Puller	23
		SECURPART Calf Puller Modell A	
		800 Bayern	23
		Self-adhesive Bandage EquiLastic	113
		SH30 Float Bowl	161
		Sharpening Stone	110
		Shearing Blade Set Premium	131
		Shearing blades	209
		Shearing blades Econom.	129
		Sheep Shearing Machine constanta4	208
		Sheep Shearing Machine FarmClipper	209
		Shoeing Hammer	111
		Shoeing Mallet	111
		Silbertape Hoof Bandage	119
		Slurry Pusher	174
		SmoothGrip Finely knitted glove	227
		SN190 Float Bowl	153
		ProStream Teat Mousetrap	199
		Snapper Rat trap	199
		Snow and grain shovel	179
		Snow Broom Nirosta	34
		Snugboot Pioneer	224
		Snugboot Wildlander	225
		Snugboot WorkPro Full Safety	225
		Soft Soap Edelweiß	75
		Softshell Protective Sleeve	81
		Soldering iron	95
		Sowotaan 200 Udder Paper	8
		Sowotaan Jumbo Udder Paper	8
		Sowotaan Wet Udder Paper	9
		Spare Cord	23
		Spare Parts for Cow Immobiliser	100
		Special Aluminium Shovel Profi	178
		Speedy Drencher	37
		Speedy Feeder Calf Bottle	36
		Spiral Curry Comb	122
		Spray Guns	78
		Spray Oil WL-75	5
		Spray Rinser Komfort	78
		Spray Shower orig. Gilmour	78
		SprayMaster Aerosol grip	135
		Square hay rack Hobby	144
		Square hay rack Standard	143
		Squeegee	176
		Squeegee Premium	176
		ST-73 Foam Lance	79
		Stable Fly Catcher FlyMaster	198
		Stable Fly Roll ECO	196
		Stable Flypaper Sheet FlyMaster	197
		Stainless Steel Bucket	173
		Stainless Steel Lid	91
		Stainless Steel Water Trough	157
		Standard Cattle Hobbles	26
		Standard Cow Lifting Frame	27
		Standard Dip Cup	71
		Standard Hoof Abrasive Disc	108
		Standard Hoof Mat	120
		Standard Numbering block	137
		Standard Square hay rack	143
		Standard Wooden Block	115
		StimuClean Udder Paper	66
		Strip Curtain Set	182
		SuckStop Müller Cattle Weaner	99
		Super Jet Rinser	77
		SuperKombi Footbath Container	120
		SuperKombi Mini Footbath Container	207
		SuperProfi Hoof and claw knife	109
		SuperProfi Hoof Cutting Disc	108
		Supplies Set Economy	4
		Supplies Set Premium	4
		Syringe Drencher	38
		T	
		Teat	30, 33, 206
		Teat Activity Set	59
		Teat Bandage UdderSoft	73
		Teat Big Softy	33
		Teat cannula	70
		Teat Cup Brush	86
		Teat Leimer	34
		Teat Pens	70
		Teat Protector	73

Teat Spraying System ProStream	11	Water Bowl K75	147
Teat tips	70	Water Bowl KN50	153, 154
Technobase 8000	114	Water Bowl Mod. 221500	148
Technovit® 6091	114	Water Bowl Mod. 222000	149
Technovit®-2-Bond	116	Water Bowl N20	154
TECNALL Dehorning Saw	97	Water Bucket	173
Teething Ring	59	Water trough	152
Texas Cattle Brush	127	Weigh Scoop	169
Thermal Container HeatBox	118	Weigh Scoop Inverted Handle	169
Thermal Trough	166	Weight	137
ThermoPlus Calf blanket	61	Winter Boots Blizzard	223
Tip trough	158	Winter Glove IceGrip	230
Top Quality Cattle Tethering	105	Wire Saw	97
Top-Qualität Cattle Hobble	26	WL-75 Spray Oil	5
TopMarker Cattle Marking Pen	135	Wooden Block	115
TopMarker Marking Spray	135	Wooden Block Standard	115
topTEMP Digital thermometer	202	Wool Teat Plug	70
Torqui Precision Adjusting Aid	128	Wool Teat Plug Uddero Dil	70
Transformer	162	Work Boots Dee	223
Treatment Shoe	112	Work Boots Pricemaster	222
Triangular Trough	142	WorkFire Pro 30 Mobile	
Trough for concentrated feed	141	LED Battery Spotlight	191
Tubbease™ Hoof Shoe	112	WorkFire Pro Mobile	
Twist Jet Rinser	77	LED Battery Spotlight	192
Twister Fly Catcher	198	Wound care spray	73
Typ 4 Plant Protection Overall	210		

U

Udder Care Products CareMINT	72
Udder Care Products SalvoCare Mint	14
Udder Cloth	67
Udder Cloth ProfilacDermatex	9
Udder Cloth UdderoClean	68
Udder Gel	72
Udder Hair Remover PREVENTA	87
Udder Paper	67
Udder Paper ProfilacDermacel	9
Udder Paper Sowotaan 200	8
Udder Paper Sowotaan Jumbo	8
Udder Paper Sowotaan Wet	9
Udder Paper StimuClean	66
Udder Paper UdderoClean	66, 67
Udder Wood Wool	69
Uddero Dil Wool Teat Plug	70
Uddero Sprayer Dip Sprayer	71
UdderoClean Udder Cloth	68
UdderoClean Bag	67
UdderoClean Udder Paper	66, 67
UdderoSoft Teat Bandage	73
Ultrasound Device Felix	199
UNIK LOW S5	216
Universal and boiler brush	84, 158
Universal Bucket	173
Universal Cleaning Sponge	89

V

Vacuum Pump Oil	5
Vacuum Pump Oil VCL 22	5
Valve FixClip New Generation	30
Valve trough drinker	156
VCL 22 Vacuum Pump Oil	5
VETbasic Veterinary disposable gloves	25
Veterinary disposable gloves VETbasic	25
Veterinary disposable gloves VETtop	25
VetGel Lubricating Gel	25
Vetlastic Hoof Bandage	113
VetTape Hoof Bandage	119
VETtop Veterinary disposable gloves	25
Viscano Milking Machine Oil	91
Viscano Multipurpose Grease	170
Vitagol Bolus	63

W

Walkease Hoof Care	118
Wall bracket	12, 83
Wall Roll Holder	68, 75
Washing and Cleaning Overalls	211
Washing brush	84, 85
Water Bowl	153
Water Bowl E21	147
Water Bowl G16	148
Water Bowl G51	147
Water Bowl H10	160

Y

Yelltor Full Cowhide Glove YELLTOR	229
Young bull tethering	106
Young cattle tethering	104

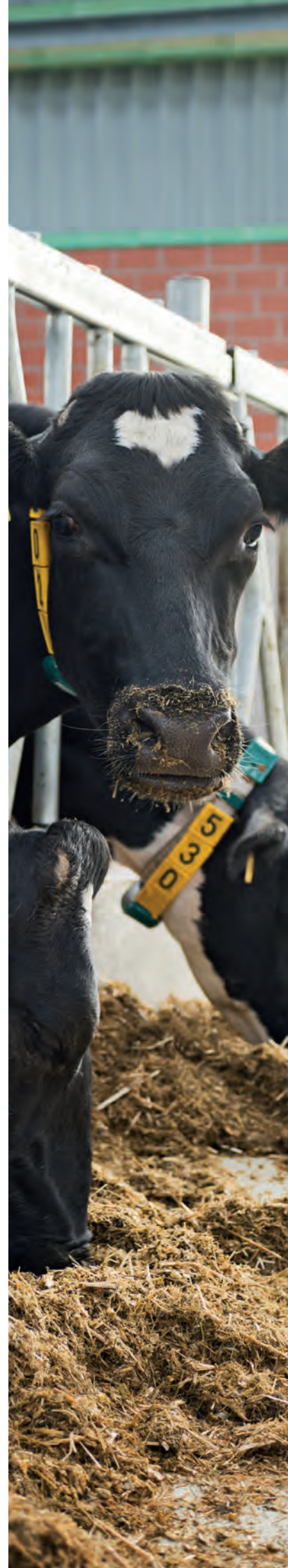

We live our values.

Excellence · Passion · Integrity · Responsibility · GEA-versity

GEA Group is a global engineering company with multi-billion euro sales and operations in more than 50 countries. Founded in 1881, the company is one of the largest providers of innovative equipment and process technology. GEA Group is listed in the STOXX® Europe 600 index.

GEA Germany

GEA Farm Technologies GmbH

Siemensstraße 25 - 27
D-59199 Bönen

Tel +49 (0) 23 83 93 7-0
Fax +49 (0) 23 83 93 8-0

info@gea.com
gea.com/contact

We do our best to constantly improve our range of products and keep it up-to-date. Thus we reserve the right to change the design of our products. With the publication of this catalogue all previous catalogues and price lists for the respective products are void. All prices provided are the manufacturer's recommended retail prices and are inclusive of VAT. All information is subject to typing and printing errors. All prices are subject to change. Changes in colour and design may occur due to printing technology reasons. Reprinting in whole or in part is due to prior authorisation.

© 10/2020