



Electronic Controller



Safety, Installation and Maintenance Instructions



CODE	DESCRIPTION	LAMP HOLDERS	LAMP DIAMETER	WATT	LAMP LENGTH
RACRE1U5X	Electronic Controller - Single Lamp	IP67	T5 Ø16mm	24/39W	550/850mm
RACRE154X	Electronic Controller - Single Lamp	IP67	T5 Ø16mm	54W	1150mm
RACRE2U5X	Electronic Controller - Double Lamp	IP67	T5 Ø16mm	24/39W	550/850mm
RACRE254X	Electronic Controller - Double Lamp	IP67	T5 Ø16mm	54W	1150mm

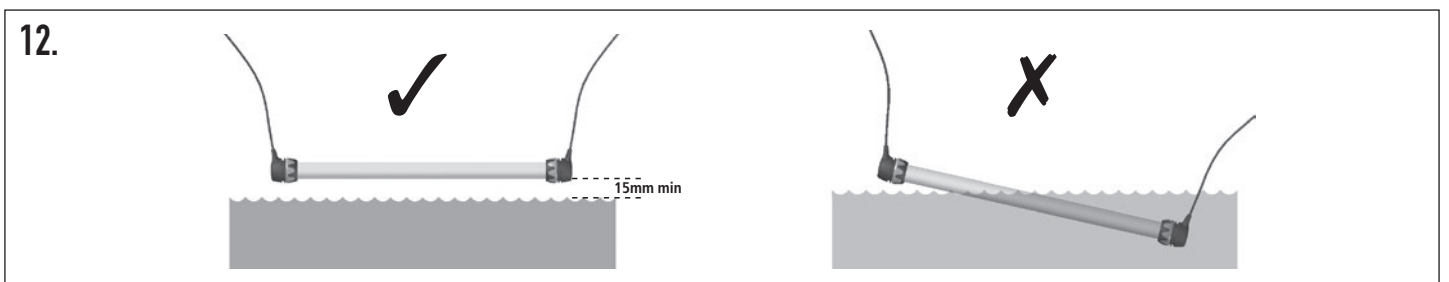
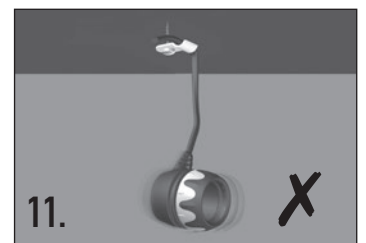
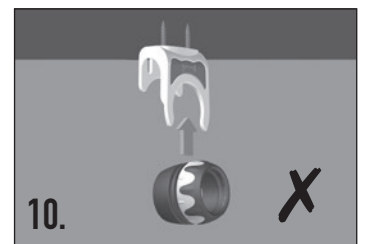
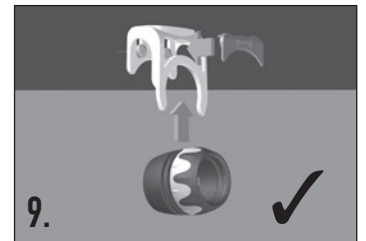
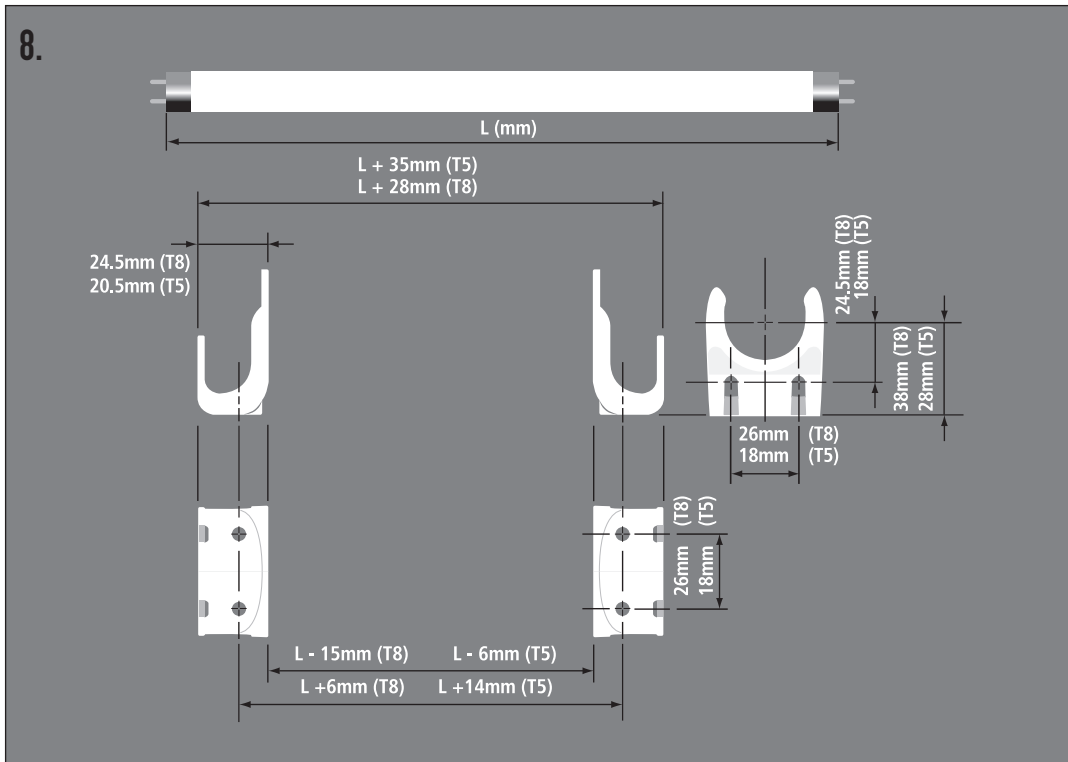
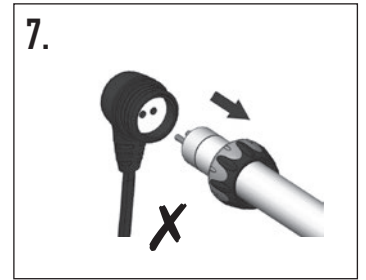
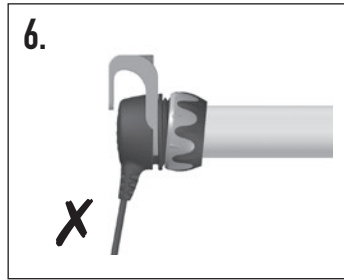
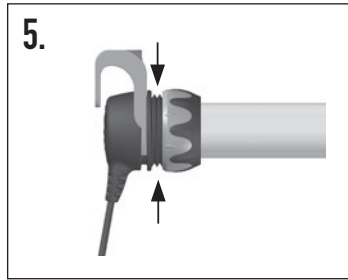
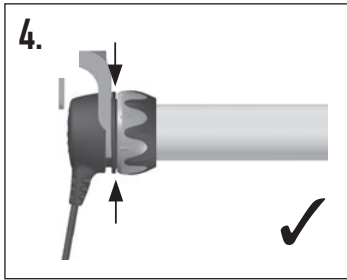
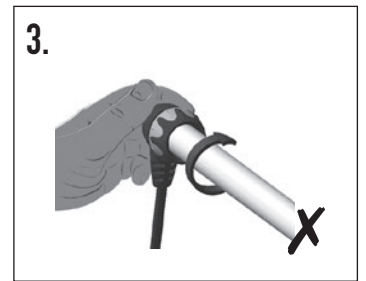
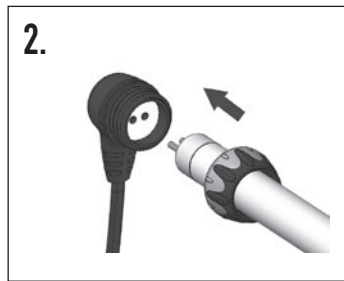
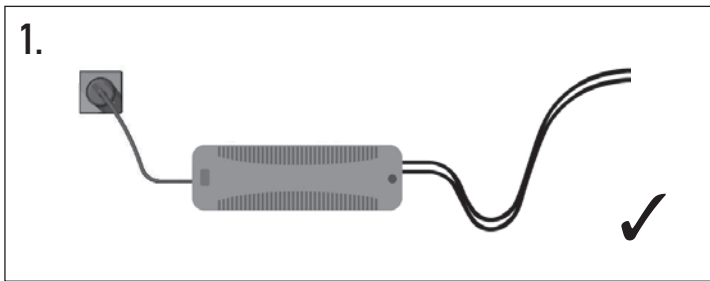

REPTILE CONTROLLER - VIVARIUM 'PLUG & SOCKET' CONTROLLER

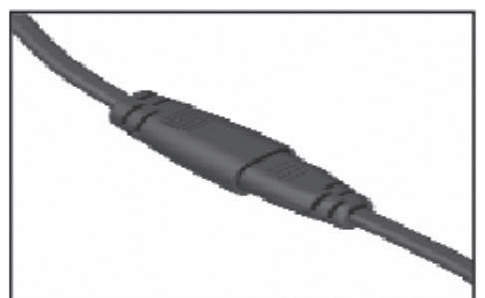
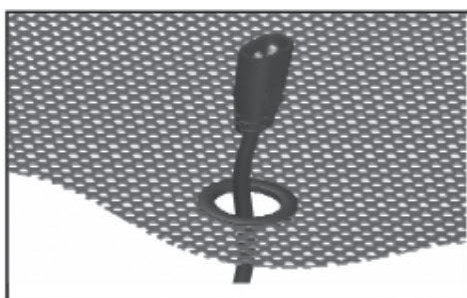
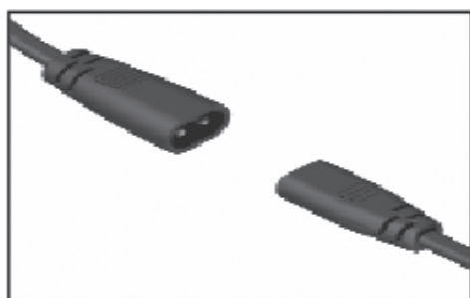

KEEP THESE INSTRUCTIONS FOR FUTURE REFERENCE. READ AND FOLLOW ALL SAFETY INSTRUCTIONS.

DANGER – To avoid possible electric shock, special care should be taken since water may be employed in the use of aquarium and vivarium equipment. For each of the following situations, do not attempt repairs by yourself; return the appliance to an authorised service facility for service or discard the appliance, to avoid hazards:

1. If the appliance falls into the water, DO NOT reach for it! First unplug it and then retrieve it. If electrical components of the appliance get wet, unplug the appliance immediately.
2. If the appliance shows any sign of water leakage, immediately unplug it from the power source.
3. Carefully examine the appliance after installation. It should not be plugged in if there is water on parts not intended to get wet.
4. Do not operate any appliance if it has a damaged cord or plug, or if it is malfunctioning or has been dropped or damaged in any manner.
5. To avoid the possibility of the appliance plug or socket getting wet, position the tank/vivarium to one side of a wall mounted socket to prevent water from dripping onto the socket or plug.

A "drip loop" should be arranged by the user for each cord connecting an aquarium appliance to a socket. The "drip loop" is that part of the cord below the level of the socket, or the connector if an extension cord is used, to prevent water travelling along the cord and coming in contact with the socket. See illustration 1

Close supervision is necessary when any appliance is used by or near children.

Always unplug an appliance from an outlet when not in use, before putting on or taking off parts, and before cleaning. Never pull on the cord to remove the plug from the socket. Instead, grasp the plug and pull to disconnect.

Do not use this controller other than for the intended use. The use of non- Arcadia attachments or accessories is not recommended.

Do not install or store the appliance where it will be exposed to the weather or temperatures below freezing.

Make sure the lampholders are securely mounted before turning on the luminaire.

Read and observe all the important notices on the appliance.

DO NOT SUBMERGE ANY PART OF THIS CONTROLLER

LAMP INSTALLATION

Your controller is not supplied with a lamp. We recommend that the relevant wattage Arcadia lamp is used. Please ensure that the correct wattage lamp is used.

Unplug before installing the lamp or lamps.

To install a lamp:

Unscrew the ring from each Ultra Seal lampholder.

Fit the rings onto each end of the lamp, an inert lubricant can be used to aid assembly.

Align pins on lamp to the lampholder holes and insert the lamp by pushing the lamp directly into the lampholder. **See illustration 2**

Screw the rings tightly onto the lampholder body. Do not twist the lamp within the lampholder. **See illustration 3**

The ring is fully tightened when there is no gap between the ring and the body. **See illustration 4 / 5**

Ensure that the ring is not cross-threaded. **See illustration 6**

To remove the lamp, switch off and unplug the supply, undo the ring from the lampholder body and pull the lamp directly out from the lampholder. Do not twist the lamp in any way. **See illustration 7**

Never use this Ultra Seal Electronic Controller without lamps in place.

NOT SUITABLE FOR USE WITH UVC LAMPS.

PHYSICAL INSTALLATION

Select a suitable site close to your electricity supply.

Place the controller on a firm surface and NOT on carpets or similar fabric surfaces.

It must not be placed inside Aquariums or Vivariums.

FITTING THE MOUNTING BRACKETS:

Use a suitable fixing for the mounting surface. **See illustration 8**

The mounting bracket is suitable for a vertical or horizontal mounting surface – please ensure that the lampholder cable and insulation remain unstressed. **See illustration 9 / 10 / 11**

Do not mount directly to the aquarium glass.

When mounting, lamps, lampholders or cables must not sit closer than 15mm to the water level. **See illustration 12**

Please ensure that the lamp cables are positioned so that they cannot be damaged.

The controller is only suitable for indoor use, and must only be used with an aquarium, vivarium or aviary.

The controller should be kept dry, ventilated and away from other heat sources.

Make sure that all the light from the luminaire is solely aimed into the aquarium, vivarium or aviary. Do not allow the light to spill out, viewing some lamps directly could be harmful to the human eye.

TECHNICAL SPECIFICATIONS

For electrical information please refer to the rating label on the controller.

Although the Ultra Seal lampholders are waterproof, when correctly assembled, they must not be submerged in water.

Do not lengthen or modify the lamp leads on this controller.

Ensure this controller is a minimum of 1 meter away from any radio or television, to reduce any possible EMC.

ELECTRICAL INSTALLATION

Before installing, ensure that the voltage and frequency of the controller match that of your supply. If in doubt, please return the unit to the point of purchase to verify.

TROUBLE SHOOTING

If the controller does not light:

Check that the mains power is connected and switched on both at the wall and at the switch.

Check that the controller is rated for the same supply voltage that you are using.

Check that the lamp is of the correct wattage and type.

Check that the lamps are installed correctly.

Check the fuses in the mains supply.

If the lamp still fails to light, replace the lamp or lamps.

MAINTENANCE

The controller can get warm. Allow adequate time for it to cool before attempting any maintenance.

CAUTION! Disconnect the mains lead of the controller before putting your hands in any water.

The mains lead of this controller cannot be replaced, if it is damaged, the controller should be disposed of at an appropriate civic recycling centre.

Cleaning: Always clean the controller when it is disconnected from the supply, and when it is cool.

Both the appearance and performance of your controller can benefit from regular cleaning.

A damp cloth is normally adequate to clean the body.

Only use the recommended lamp type for the purchased unit.

Replacement parts:

Replacement sealing rings (pair)

T5 (16mm/5/8") RAB5R

T8 (26mm/1") RAB8R

END OF USE RECYCLING INFORMATION

This product is covered by European Directive 2002/96/EC. Please do not dispose of this product or replacement lamps with your normal household waste. To safely and responsibly dispose of the product please ensure all the components are deposited in the appropriate areas of your local civic recycling centre. Proper disposal of this product helps to prevent potential negative consequences for the environment and human health.

All electronic components (this includes the power supply and the lamp holder) should be placed in the electronic waste recycling area.

If a fluorescent lamp is provided with this product it contains mercury, and cannot be disposed of with normal household waste; it should be deposited in the fluorescent lamp recycling area at your local civic recycling centre or taken to any approved recycling point for fluorescent lamps.

