

Mythology Photography Fiction Fishing
Christianity Art Cooking Essays
Buddhism Freemasonry Medicine Biology
Music Ancient Egypt Evolution
Carpentry Physics Dance Geology
Mysticism Fitness Shakespeare
Marketing Confidence
Immortality Biographies Poetry
Witchcraft Electronics
Chemistry History Law Accounting
Philosophy Anthropology Alchemy Drama
Quantum Mechanics Atheism Sexuality
Personal Health Ancient History Criminal
Empire History New York City
Metaphysics Investment Archaeology

Forgotten Books

— www.forgottenbooks.com —

Copyright © 2016 FB &c Ltd.

All rights reserved. No part of this publication may be reproduced, distributed, or transmitted in any form or by any means, including photocopying, recording, or other electronic or mechanical methods, without the prior written permission of the publisher, except in the case of brief quotations embodied in critical reviews and certain other noncommercial uses permitted by copyright law.

PAXTON'S
MAGAZINE OF BOTANY,

AND

REGISTER OF FLOWERING PLANTS.



"Flowers of a'l hue"

VOLUME THE FOURTH.

LONDON:
PUBLISHED BY W. S. ORR & CO., PATERNOSTER ROW.

MDCCXXXVIII

LONDON:
BRADBURY AND EVANS, PRINTERS,
WHITEPRIARS.

TO THE MOST NOBLE

J O H N R U S S E L L,

DUKE OF BEDFORD, K. G., &c. &c.

This Fourth Volume

OF

THE MAGAZINE OF BOTANY

MOST RESPECTFULLY AND HUMBLY DEDICATED,

IN CONSIDERATION OF

THE UNWEARIED PATRONAGE WHICH HIS GRACE, FOR A VERY LONG PERIOD OF YEARS,
HAS GIVEN TO BOTANICAL PURSUITS,

BY

HIS GRACE'S MOST OBLIGED HUMBLE SERVANT,

JOSEPH PAXTON.

ADVERTISEMENT.

THE MAGAZINE OF BOTANY has now reached the close of the Fourth Volume, with a circulation far more extensive than any work of the description and price could reasonably expect; proving thereby that a desire for Botanical and Horticultural knowledge is progressively on the increase. This is truly gratifying to the author, as it shows that the design which first led him to the undertaking has been in a great degree answered, viz.—that of inducing more extensively a knowledge of and love for the cultivation of beautiful plants, by disseminating, in a manner to be understood by all, such particulars relating to their cultivation, as would render them accessible to every collection.

In endeavouring to accomplish this, botanical terms difficult of pronunciation have been carefully avoided, and their places supplied by others more easy and familiar, so that those who have only a small collection of plants, or those even who are only beginning to appreciate the beauties and peculiarities of Botany, may at once be put in possession of the leading features in this very interesting and amusing study. The author by no means flatters himself that his labours in this volume will be found free from defects to the eye of the Botanist; still even to him it may

have its use, by teaching the propriety of dispensing with all unnecessary and abstruse botanical terms, so that the amateur and gardener may derive equal advantage and amusement.

To render the work still more serviceable, the author intends, in future numbers, to insert a series of plans for flower gardens, &c. These plans will be given of various forms and sizes, calculated to suit a variety of situations: the character and style also of the designs will vary, so that the taste of individuals may be exercised in selecting the most suitable. Such new plants as recommend themselves by their beauty, &c., will be regularly figured in the next volume, and all useful facts connected with their history and cultivation carefully detailed: and the earliest account of every new plant that flowers in the London nurseries, will be fully detailed, and every particular that is disclosed about them, made known.

In conclusion, the author begs to offer his grateful thanks for the encouragement and support he has hitherto received, and to express his earnest desire that the Magazine of Botany should continue to be useful and beneficial to his readers.

CHAISWORTH,

December 20, 1837.

LATIN INDEX

TO

THE COLOURED FIGURES OF PLANTS.

-
- | | |
|------------------------------------|---|
| ACACIA longifolia, 197 | Leucothoe floribunda, 101 |
| — pulchella, 198 | Lissochilus speciosus, 25 |
| Agrostemma Bungeana, 7 | |
| | Malva Munroana, 269 |
| Begonia odorata, 123 | Muraltia Heisteria, 150 |
| Boronia crenulata, 267 | — stipulacea, 149 |
| Brugmansia Waymannii, 241 | Mimulus Harrisonia, 173 |
| | |
| Cattleya labiata, 121 | Nepenthes distillatoria, 1 |
| — Harrisoniæ, 247 | |
| Chorizema ovata, 153 | Oncidium citrinum, 77 |
| Clematis Sieboldii, 147 | — Lanceanum, 169 |
| — cœrulea, 193 | |
| Clintonia pulchella, 145 | Pancratium calathinum, 53 |
| Costus speciosus, 245 | Pentstemon Cobæa, 243 ; Gentianoides, 265 |
| | Petrea Stapelsiæ, 199 |
| Daviesia ulicina, 29 | Podolobium staurophyllum, 171 |
| Dillwynia glycinifolia, 99 | Poinsettia pulcherrima, 97 |
| | |
| Epacris variabilis, 125 | Renanthera coccinea, 49 |
| — impressa, 126 | Russelia juncea, 79 |
| Euphorbia fulgens, 31 | |
| | Siphocampylus bicolor, 195 |
| Fuchsia globosa ; var. elegans, 75 | Statice arborea, 217 |
| | |
| Gesneria Selloi, 27 | Tropæolum brachyceras, 55 |
| | Verbena Tweediana, 5 |
| Lælia anceps, 73 | Zygopetalum maxillare, 271 |

ENGLISH INDEX

TO

THE COLOURED FIGURES OF PLANTS.

-
- | | |
|---|--|
| ACACIA, long-leaved, 197 | Lælia, two-edged, 73 |
| — pretty zigzag spined, 198 | Leucothoe, bundle-flowered, 101 |
| Air-Plant, Chinese scarlet-flowered, 49 | Lissochilus, Griffin's showy, 25 |
| Arboreus Statice, 217 | |
| | Mallow, Mr. Munro's, 269 |
| Begonia, sweet-scented, 123 | — Heister's, 150 |
| Boronia, crenate-leaved, 267 | Milkwort, stipular, 149 |
| Brugmansia, Wayman's variety, 241 | Mimulus, Harrison's, 173 |
| | |
| Campion, Bunge's scarlet, 7 | Oncidium, lemon-flowered, 77 |
| Cattleya, crimson-lipped, 121 | — Lance's, 169 |
| — Mrs. Harrison's, 247 | |
| Chorizema, ovate-leaved, 153 | Pentstemon, Cobæa-flowered, 243; Gentian-
like, 265 |
| Clematis, Siebold's, 147 | Petrea, Stapelia-flowered, 199 |
| — violet-flowered, 193 | Pitcher Plant, 1 |
| Clintonia, pretty-flowered, 145 | Podolobium, cross-leaved, 171 |
| Costus, showy-flowered, 245 | Poinsettia, showy, 97 |
| | |
| Daviesia, furze-like leaved, 29 | Russelia, rushy-leaved, 79 |
| Dillwynia, glycine-leaved, 99 | |
| | Sea-daffodil, cup-flowered, 53 |
| Epacris, variable-flowered, 125 | Siphocampylus, two-coloured, 195 |
| — impressed, 126 | |
| Euphorbia, fulgent-flowered, 31 | Tropæolum, short-spurred, 55 |
| | |
| Fuchsia, elegant globe-flowered, 75 | Vervain, Tweedie's scarlet, 5 |
| | |
| Gesneria, Sellow's, 27 | Zygopetalum, tooth-like flowered, 271 |

WOOD-CUT ILLUSTRATIONS

VOLUME THE FOURTH.

GARDEN STRUCTURES.

- DESIGN for a new Flower Stand, 59
 — Cast-Iron Garden Chair, 206
 Garden Architecture, 84, 85, 86
 Hot-water Apparatus,—
 Boiler detached, 33
 Chimney, 33
 Frame or base on which the Boiler is fixed,
 34
 Apparatus complete, 34
 Most convenient mode of application, 35
 Complete section of, 36
 Hollow plug, for closing the ends of the
 pipes, 36
 Common Circular Grate, 36
 New Plan Recommended, 37
 Ornamental Vases for the Flower-Garden or
 Pleasure-ground, 62, 63, 64

DIAGRAMS.

- Agrostemma Bungeana, flower dissected, 7

PLANTS.

- Blighia sapida, 60
 Cattleya labiata, 122
 Cinnamomum verum, 103
 Common Fig, 227
 Cucumis Colocynthus, 231
 Mimulus Harrisonia, 173
 Myristica Moschata, 178
 Myrtus pimenta, 176
 Nepenthes distillatoria 3
 Poinsettia pulcherrima, 98
 Renanthera coccinea, 51
 Russelia juncea, 80
 Swietenia Mahogani, 161





Aephanthes distillatoria

Edlin del. Smith sculp.

GENERIC C
color
same

SPECIFIC C
except
situa
nearly
parallel
length
dingy
the mo
at abou
solitary
becom
each su
blunt,
club-sh
Bot. Mag.

THIS
the year I
Wentwor
seeds gath
by the ex
The pla
Britain, be
full grow

presents a most magnificent and singular
the stove on a slight elevation, above th
not being sufficiently lofty to admit of an u
necessary, about twelve months ago, to train
of the lights, since which the growth has been
branch bent down to break out into several st

VOL. IV.—NO. XXXVII.

tion Scanner:
out in Book!

NEPENTHES DISTILLATORIA.

(PITCHER PLANT.)

CLASS.
DICECIA.

ORDER.
MONADELPHIA.

NATURAL ORDER.
NEPENTHEACEÆ.

GENERIC CHARACTER.—*Male*, *Calyx* four-parted, spreading, inside coloured. *Corolla* none. *Filaments* columnar. *Anthers* from fifteen to seventeen, cohering at their base. *Female*, *Calyx* and *Corolla* same as the male. *Stigma* pelate. *Capsule* four-celled, many-seeded. }

SPECIFIC CHARACTER.—A half shrubby caulescent stove plant, more than twenty feet high. *Stem* green, except at the bottom, where it is brown, round, and woody, the upper part thickest. *Buds* small, situated a little above the axil of the leaves. *Leaves* green, entire, undulated, smooth, scattered, nearly two feet in length, semi-amplexicaul, veins most conspicuous in the old leaves, running nearly parallel with the midrib, and reticulated. *Midrib* a rusty brown colour, very prominent behind, lengthening into a tortuous pendulous tendril of the same colour, bearing at the extremity an erect dingy brown pitcher, which is surmounted by a round rather darker lid connected at the back part of the mouth, as shown in the plate. This lid in the young pitcher is closed; when old it remains open, at about a right angle with the mouth. *Flowers* diœcious, disagreeable to the smell, produced on a solitary rusty brown raceme, at first nodding, afterwards, as the flowers expand in succession, it becomes more erect. *Flower-stalks* same colour as the raceme, round, half an inch long, clustered, each supporting two flowers. *Calyx* a greenish red, four-parted, somewhat reflexed. *Segments* blunt, leathery, containing honey. *Anthers* many, collected into a head on the summit of a hollow club-shaped footstalk, formed by the united filaments. *Pollen* a yellow powder.

Bot. Mag. 2798.

THIS extraordinary plant, according to the Hortus Kewensis, was introduced in the year 1789, but was shortly after wholly lost to the country, until Mr. Cooper of Wentworth, and the Messrs. Shepherds of Liverpool, succeeded in raising plants from seeds gathered on the Circar Mountains, to the north-east of Bengal, and sent them by the excellent Dr. Carey.

The plant at Chatsworth, which without doubt is the finest grown specimen in Britain, being more than twenty feet high, and having on it at this time near fifty full grown pitchers, hanging gracefully from the points of the strongest leaves, presents a most magnificent and singular appearance; it stands at one end of the stove on a slight elevation, above the level of the floor, and the house not being sufficiently lofty to admit of an uninterrupted erect growth, it became necessary, about twelve months ago, to train the leading shoot down under the bars of the lights, since which the growth has been so luxuriant as to cause part of the branch bent down to break out into several strong shoots, so that the upper part or

head of the plant now occupies a considerable space of the roof at that end of the house where it is growing. In this state, from the number and size of the pitchers, and the easy and careless-like manner they hang from the tips of the leaves, the whole presents an almost inconceivably singular appearance, and we may add, that so exuberant has been the growth, that the flower spikes have in their progress considerably disfigured and fractured that part of the stem where they spring from, so as to leave an incision in the bark above and below the base of the flower spike, as if it had been made with a knife.

It commenced flowering as much as eighteen months ago, since which it has successively continued by the development of new spikes from the lateral shoots.

The cultivation of this plant has been regarded by most cultivators as extremely difficult; but any one seeing the plants at Chatsworth would be led to think that could not be the case, for the plants here have such a healthy appearance, and their growth so free, that we very much question whether they are not as fine or finer than, plants growing in, and enjoying all the advantages of, their native soil; and not only do the plants themselves succeed so well, but they are increased with equally satisfactory success. Our experience has clearly taught us that heat at the roots is as necessary to the successful growth of this plant as a heated atmosphere is indispensable to the stem and leaves. The plants at Chatsworth (we say plants, because more than one is growing in the same part of the house) are placed directly on the top of the entrance of one of the main flues, except that a little coarse material is put under the pots to prevent the moss in which they are immersed from taking fire when the flue covers may happen to become unusually heated. This moss is kept rather wet, so that from the heat of the flue a constant but gentle humidity is given off, which rises amongst the plants in the form of an invisible vapour, and thus strengthens while it promotes their growth. The heat of the moss we should say is generally about 80° , while the atmosphere of the house rarely, excepting in summer, averages 70° .

The old plant throws out from the base of the stem at uncertain periods three or four off-sets; these, when a few inches long, or when each has made three or four leaves, is taken off and potted singly in thirty-two sized pots, using as compost a little coarse fibrous peat, mixed with a greater proportion of the Hypnum Moss (*Hypnum proliferum*), each is then plunged into the moss as before directed; and as the plants grow, and the rootlets in the pots become numerous, an additional sized pot is given to each, using precisely the same materials in potting as before, observing to secure a good open drainage at the bottom of each. In the summer, when the house is well heated, a slight washing with the syringe in the evening will be serviceable. It is not advisable to expose the plants to the direct influence of the mid-day sun, still their growth and appearance will be improved if a good share of

light is admitted to them. Our plants do not, it is true, often enjoy the direct rays of the sun, still their situation is very light, and they seem so much at home in it that we may liken them to a little forest, progressing in all its native luxuriance.

We have measured different parts of the plant, and find the following to be the result:—Height, more than twenty feet; length of the fullest grown pitchers, from the base to the rim of the mouth, six to nine inches; circumference at the broadest part, five inches; length of the leaf, two feet; breadth of ditto, three inches. We have found the opened and unopened pitchers to contain a more or less quantity of pure sweet water, and invariably we find the opened ones to contain insects, but whether this goes to strengthen the supposition that this fluid is intended to decoy them we are unable to say.

It has been asserted, and with some probable truth, that this liquid is a secretion from the minute glandular scales by which the lower half of every pitcher is lined. “Dr. Turner analysed the contents of a large one, and found it to emit, while boiling, an odour like baked apples, from containing a trace of vegetable matter, and he found it yield minute crystals of super-oxalate of potash on being slowly evaporated to dryness.”—*Bot. Mag.* 2798.

For further accounts of the supposed uses of this extraordinary feature of vegetable life, we refer the reader to pages 57 and 58 of the first volume of this Magazine. And as an esteemed author observes, that few indeed are the phenomena attending plants, either in their structure or their economy, which we can satisfactorily explain; everything, however, tends to make this grand truth more evident and more indisputable, that God in infinite wisdom and goodness has made them all.

The accompanying diagram is intended to show the sort of trellis used in training

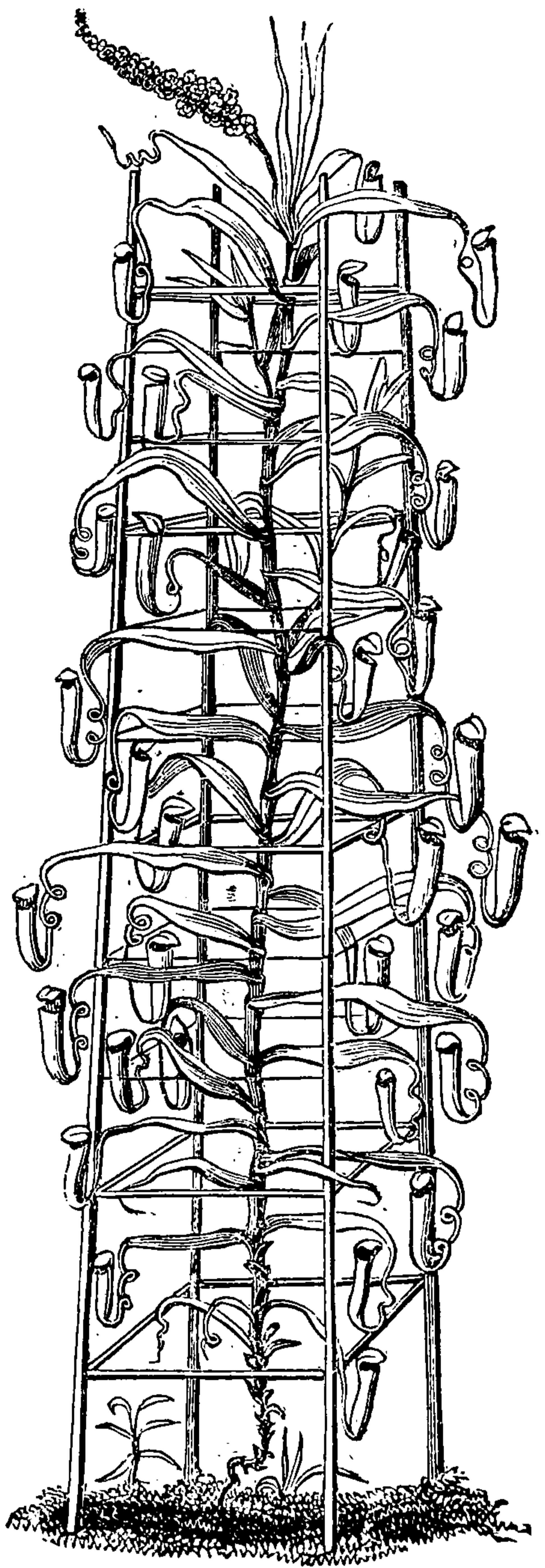

these plants ; it consists of four deal stakes formed into a square, with copper wire passing horizontally from each at about every two feet. The plant is conducted up the centre, and the copper wire serves admirably for bearing up the leaves or pitchers that may be too weak to support themselves.

In what way the generic name *Nepenthes* applies to this plant it is impossible to conceive ; but it is a name under which Homer speaks of a substance, probably opium.

The specific name, *distillatoria*, signifies distilling.



THIS PAGE IS LOCKED TO FREE MEMBERS
Purchase full membership to immediately unlock this page



Never be without a book!

Forgotten Books Full Membership gives universal access to 797,885 books from our apps and website, across all your devices: tablet, phone, e-reader, laptop and desktop computer

A library in your pocket for \$8.99/month

Continue

*Fair usage policy applies



Verbena Tweediana

E. W. Smith sculp

FEB 1837

VERBENA TWEEDIEANA.

(MR. TWEEDIE'S SCARLET VERVAIN.)

CLASS.
DIDYNAMIA.

ORDER.
ANGIOSPERMIA.

NATURAL ORDER.
VERBENACEÆ.

GENERIC CHARACTER.—See Vol. I., p. 173.

SPECIFIC CHARACTER.—Plant perennial, clothed with pubescence. *Branches* square, suffruticose, erect, spreading. *Leaves* opposite, ovate, lanceolate, tapering to a sharp point, rather deeply serrated, serratures acute. *Flower-stalk* upwards of nine inches long. *Flowers* a rich rosy crimson, disposed in a corymb. *Calyx* cylindrical, five-ribbed. *Corolla* a rather pale slender tube, *limb* divided into five equal very obtuse slightly cut lobes.

Bot. Mag. 3541.

EVERY one of our readers, we make no doubt, is well acquainted with that lovely plant *Verbena Chamædrifolia* (*Melindris*), whose brilliant scarlet flowers almost dazzle the eyes of the beholder. The species before us is said to surpass it both in beauty of flowers and elegance of growth, growing more erect, and being covered with a dense mass of conical-shaped rosy crimson flowers.

It was raised last year by Mr. Niven, of the Dublin Botanic Garden, from seed sent there by Mr. Tweedie, who found the species plentifully in boggy places, at Laguna de la Molina, in the Banda Oriental; where, he remarks, its large brilliant heads of crimson flowers have a most splendid appearance.

Being an autumnal flowering plant, and of easy culture, it will prove a great accession to our Autumnal Flora; it grows freely in rich sandy loam, with a little peat, and is readily increased either by layers or cuttings.

Mr. George Cunningham, of the Liverpool Nursery, who has the whole disposable stock of this charming plant, kindly furnished us with the accompanying drawing in November last.

The generic name will be found explained in Vol. I., page 174.

The specific name is given by Mr. Niven, in compliment to its indefatigable discoverer, Mr. Tweedie.



E. W. Smith del. & sculp.

Agrostemma Bungeana

FEB 1897

AGROSTEMMA BUNGEANA.

(DR. BUNGE'S SCARLET CAMPLON.)

CLASS.
DECANDRIA.

ORDER.
PENTAGYNIA.

NATURAL ORDER.
CARYOPHYLLÆ.

GENERIC CHARACTER.—*Calyx* tubular, persistent, sepals five. *Corolla* five-petalled, hypogynous. *Stamens* ten. *Leaves* opposite. *Capsule* two to five-valved, seeds indefinite.

SPECIFIC CHARACTER.—*Herb* perennial, growing from one foot to eighteen inches high. *Leaves* lanceolate, pubescent. *Flowers* terminal, solitary. *Calyx* tubular, ten-ribbed, ten-toothed, the alternate ones shorter, hairy. *Petals* five, scarlet, one inch and a half long, cut into five or six unequal lobes. *Stamens* ten. *Filaments* white. *Anthers* blue. *Stigmas* five, shorter than the stamens. *Capsule* ovate.

British Flo. Gard. 317. SYNONYME, *Lychnis Bungeana Hortulan.*

THIS very beautiful herbaceous plant we believe to be perfectly hardy, it makes a fine bed, and will continue to flower, if planted in rich soil, a considerable time during the summer; it was introduced to the gardens of this country through Messrs. Booth of Hamburgh. Dr. Bunge, after whom it is named, travelled with the author of *Flora Altaica* through the Altai Mountains, and it is believed to be a native of Asiatic Russia.

It is easily propagated by division of the root, or cuttings, and it occasionally produces seeds.

The plant grows taller, and the flowers become larger, if grown with care and kept in a frame or greenhouse.

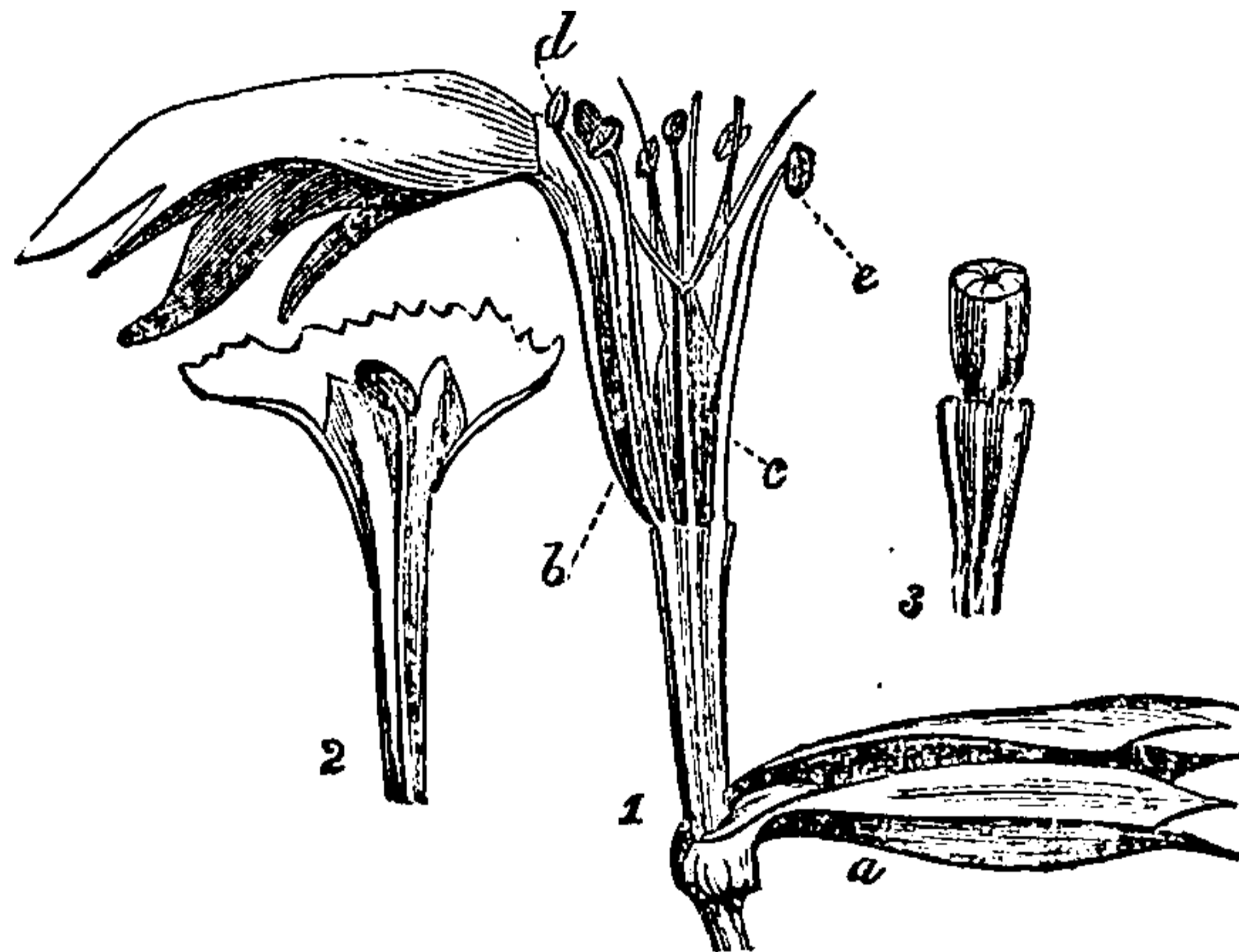

Fig. 1, flower with part of the petals removed; *a* the calyx; *b* a petal, showing its insertion; *c* the ovary; *d* one of the five longer stamens, showing its position on the crest at the top of the petal stalk (shown also at *Fig. 2*); *e* one of the five shorter stamens; *Fig. 3* a transverse section of the ovary to show the central receptacle on which the ovules grow.

Immediately after the accompanying drawing was taken, we received a beautiful specimen of this plant, with six fine expanded flowers, from Mr. David Smith, of the Hull Botanic Garden, who observes—"I received this very showy and interesting plant through the kindness of Mr. Booth, proprietor of the Flotbeck Nursery, Hamburgh. I have found it of easy cultivation, preferring a light, fresh, loamy soil; some specimens, grown in 48-sized pots, attained the height of from 3 to 4 feet, and kept in flower in a cool greenhouse for nearly two months. So late in the summer as July, I turned a plant of it out into a south border, and it showed no less than forty flowers by September, but the weather became very cold and they did not expand. When planted out in May, I have no doubt of its proving one of the most showy, half-hardy plants lately introduced."

"The generic name *Agrostemma* is taken from *Agros*, a field, and *Stemon*, a crown; alluding to the beauty of the flowers, which were formerly made into crowns or garlands.—*G. Don.*"



THIS PAGE IS LOCKED TO FREE MEMBERS

Purchase full membership to immediately unlock this page

DELVE INTO FANTASY, MAGIC, MYTHOLOGY & FOLKLORE

Forgotten Books'
Full Membership gives
access to 797,885 ancient
and modern, fiction and
non-fiction books.

Continue

*Fair usage policy applies

degree of accuracy is required which can only be obtained by constant practice founded upon scientific principles. "The following is the analysis of a fertile soil in the neighbourhood of Bristol; in 400 grains, there were of water, 52; silicious sand, 240; vegetable fibre, 5; vegetable extract, 3; alumine, 48; magnesia, 2; oxide of iron, 14; calcareous earth, 30; loss, 6. On the utility of analysis Dr. Ure, (Dict. of Chem.) observes, that "no system can be devised for the improvement of lands independently of experiment; but there are few cases in which the labour of analytic trials will not be amply repaid by the certainty with which they denote the best methods of melioration, and this will particularly happen when the defect of composition is found in the proportions of the primitive earths. In supplying organic matter, a temporary food only is provided for plants, which is in all cases exhausted by means of a certain number of crops; but when a soil is rendered of the best possible constitution, and texture with regard to its earthy parts, its fertility may be considered as permanently established. It becomes capable of attracting a very large portion of vegetable nourishment from the atmosphere, and of producing its crops with comparatively little labour and expense."

3. *Of the Uses of Earths.* *Pure earths*, "exclusively of organised matter and water, are allowed by most physiologists to be of no other use to plants than that of supporting them, or furnishing a medium by which they may fix themselves" in a situation favourable to their future growth. "But earths and organic matter, that is, *soils*, afford at once support and food." Thus the *pure earths* may be considered as the mechanical agents in the soil. They consist chiefly of metallic bases united to oxygen, not readily decomposable; and consequently they cannot be reasonably supposed to be convertible into the elements of organised matter, which, as has been stated, are chiefly found to be oxygen, hydrogen, carbon, and azote. Plants, it is true, consume a small portion of the earths they grow in, as is discoverable by burning, for their ashes are found to contain earths; but the quantity has been ascertained never to equal more than a fiftieth part of the weight of the plant consumed. "The earthy parts of the soil are chiefly useful in detaining water, so as to supply the proper proportions to the roots of the vegetables, and they are likewise efficacious in producing the proper distribution of the animal or vegetable matter." The earths, when duly mixed with such matter, prevent it from decomposing too rapidly, and regulate the supply of its soluble parts in proper proportions to the roots of the plants. The earths are also "necessary to the existence of plants, both as affording them nourishment, and enabling them to fix themselves in such a manner as to obey those laws by which their radicals are kept below the surface, and their leaves exposed to a free atmosphere."

4. *The due tenacity and coherence of the soil* arise from the finely-divided matters of its constituent parts, "and they possess the power of giving those qualities in the highest degree, when they contain much alumina," (pure clay.) "A small quantity of finely-divided matter is sufficient to fit a soil for the production of turnips and barley; and a tolerable crop of turnips has been produced on a soil containing eleven parts out of twelve sand; a much greater proportion of sand, however, always produces absolute sterility." Tenacity is obtained by certain propor-

tions of finely-divided vegetable and animal decomposable matters in union with alumina.

5. *Friability, or looseness of texture*, is chiefly occasioned by the admixture of sand, and in a certain degree this quality is of importance, "in order that the operations of culture may be readily conducted, that moisture may have free access to the fibres of the roots, that heat may readily be conveyed to them, and evaporation may proceed without obstruction." "As alumina possesses all the properties of adhesiveness in an eminent degree, and silex those of friability, it is obvious that a mixture of those two earths, in suitable proportions, would furnish every thing wanted to form the most perfect soil as to water and the operations of cultivation. In a soil so compounded, water will be presented to the roots by capillary attraction: it will be suspended in it, as in a sponge, in a state of minute division, so that every part may be said to be moist, but not wet."

6. "*The power of soils to absorb water from the air* is much connected with fertility. When this power is great, the plant is supplied with moisture in dry seasons; and the effect of evaporation in the day is counteracted by the absorption of vapour from the atmosphere by the interior parts of the soil during the day, and by both the exterior and interior during the night." "The soils that are most efficient in the supplying the plant with water by absorption from the atmosphere are those in which there is a due admixture of sand, finely-divided clay, and carbonate of lime," (or chalk, which mixture constitutes a loam,) "with some animal and vegetable matter; and which are so light as to be freely penetrated by the atmosphere."

The productiveness of soils is influenced by the nature of the subsoil on which they rest. When they are immediately situated upon a bed of rock, they are rendered dry by evaporation much sooner than when the subsoil is of clay or marl. "A clayey subsoil will sometimes be of material advantage to a sandy soil, and will retain moisture so as to be capable of supplying that lost by the earth above." "A sandy or gravelly subsoil often corrects the imperfection of a too great degree of absorbent power in the true soil. In calcareous countries, where the surface is a species of marl, the soil is often found only a few inches above the limestone, and its fertility is nevertheless unimpaired; though on a less absorbent soil, this situation would occasion barrenness; and the sandstone and limestone hills in Derbyshire and North Wales may be easily distinguished at a distance, in summer, by the different tints of vegetation. The grass on the sandstone hills usually appears brown and burnt up, that on the limestone hills flourishing and green." In the Isle of Thanet, and other districts, where the subsoil is chalk to a considerable depth, the verdure of the grass, and of young trees and shrubs, is often retained during parching seasons, when in many other situations the grass is entirely scorched, and the trees lose their leaves, owing to the continuance of dry weather; this was particularly observable in the hot summer of 1818. Chalk absorbs moisture readily, and retains it tenaciously; hence, in hot, dry summers, it gradually affords moisture to the roots of plants at a time when more open and porous soils are comparatively deprived of moisture.

7. *Chemical Agency of Soils.* Besides the mechanical uses of soil, there is, according to Sir H. Davy, "another agency between soils and organisable matters which may be regarded as chemical. The earths, and even the earthy carbonates, have a certain degree of chemical attraction for many of the principles of vegetable and animal substances. The extract from decomposing vegetable matter, when boiled with pipe-clay or chalk, forms a combination by which the vegetable matter is rendered more difficult of decomposition and solution. Pure silica and silicious sands have little action of this kind; and the soils which contain the most alumina and carbonate of lime are those which act with the greatest chemical energy in preserving manure. Such soils merit the appellation which is commonly given to them of rich soils; for the vegetable nourishment is long preserved in them, unless taken up by the organs of plants. Silicious sands, on the contrary, deserve the term hungry, which is commonly applied to them; for the vegetable and animal matters which they contain, not being attracted by the earthy constituent parts of the soil, are more liable to be decomposed by the action of the atmosphere, or carried off from them by water. In most of the black and brown rich vegetable moulds, the earths seem to be in combination with a peculiar extractive matter, afforded during the decomposition of vegetables; this is slowly taken up and attracted from the earths by water, and appears to constitute a prime cause of the fertility of soil."

8. *Soils may be improved by pulverisation,* or the minute divisions of the particles by mechanical labour; and under this term are included the operations of ploughing, harrowing, digging, trenching, hoeing, and raking. It is of the most essential service to land, and induces fertility in a variety of ways. It opens the ground, and thus gives scope to the roots of vegetables; increases its sponge-like properties, and thus promotes the regular diffusion of water. It tends to increase the quantity of vegetable food, by enabling the water holding nutritive matters in solution, to convey it more equally to the roots of plants. Pulverisation, by opening the soil, promotes and assists the free ingress of heated air, and thus regulates and improves the temperature of the soil; it also introduces, and as it were buries, a portion of the atmospheric air, and thus furnishes another source of electro-chemical decompositions and combinations.

"*The depth of pulverisation,*" Sir H. Davy observes, "must depend upon the nature of the soil and subsoil. In rich clayey ground it can scarcely be too deep; and even in sand, unless the subsoil contain principles noxious to vegetables, deep comminution should be practised. When the roots are deep, they are less liable to be injured either by excess of rain or drought, the radicles are shot forth into every part of the soil, and the space from which the nourishment is derived is more considerable than when the seed is superficially inserted in the soil."

9. *A free admission of air, and exposure to the influence of heat and cold,* tend to improve the ground. "If the soil be laid up in large lumps, (or ridges,) it is evident that it will acquire more heat, by exposing a greater surface to the atmosphere; and it will retain this heat longer, from the circumstance of the lumps (or ridges) reflecting back the heat radiated by each other. A clayey soil, in this way,

it is said, (*Farmer's Magazine*, 1815,) may be heated to 120 degrees. By the aeration of lands in winter, minute mechanical division is obtained by the freezing of the water in the soil; for as the water in the solid state occupies more space than when fluid, the particles of earthy matters, and of decomposing stones, are thus rent asunder, and crumble down into fine mould."

10. *Soils may be improved by adding to, or subtracting from them, ingredients in which they are deficient, or superabound.* If a soil, of good appearance and texture, contain sulphate of iron, it may be ameliorated by quick lime; if there be excess of calcarious matter, it may be improved by the application of sand or clay. Soils too abundant in sand are benefited by the use of clay, marl, or vegetable matter.

By *burning soils* considerable chemical changes can be brought about. "The bases of all common soils are mixtures of the primitive earths and oxide of iron, and these earths have a certain degree of attraction for each other." "When clay or tenacious soils are burnt, they are brought nearer to a state analogous to that of sand. In the manufacture of bricks, the general principle is well illustrated: if a piece of dried brick earth be applied to the tongue, it will adhere to it very strongly, in consequence of its power to absorb water; but after it has been burnt, there will scarcely be any sensible adhesion."

"*The soils improved by burning* are all such as contain too much dead vegetable fibre; also, all such as contain their earthy constituents in an impalpable state of division, that is, stiff clays and marls; but in coarse sands and rich soils, containing a just mixture of the earths, and in all cases in which the texture is sufficiently loose, or the organisable matter sufficiently soluble, the progress of burning cannot be useful."—*Domestic Gardener's Manual*.

REMARKS ON THE GENUS HOYA, AND PARTICULARLY UPON HOYA CARNOSA.

WE beg to refer the reader to page 26 of the second volume: therein we have noticed many of the leading features which characterise the natural order *Asclepiádeæ*. This order is well defined, its subjects are remarkable, their botanical structure very curious, and, in many instances, they possess great beauty.

The genus *Hoya* is found in the Linnæan fifth class, *Pentandria*; in the second order, *Digynia*; the stamens, therefore, are *five*, and the pistils, or styles, *two*: the natural characters are flowers, monopetalous, inferior; *fruit* superior, being a follicle, or leaf-like capsule. Herein all the *Asclepiádeæ* agree, the genera of which are numerous. The essential characters of *Hoya* are a five-cleft *corolla*. The masses of pollen (which might be mistaken for anthers) fixed at their bases converging upwards; *stigma* depressed, with an obtuse wart; *follicles* smooth; *seeds* smooth.

These minutiae are not traceable, unless by dissection; for the reproductive

organs are hidden by the *crown*, which converges to a point in the centre of the flower, precisely over the stigma.

The species enumerated in the *Hortus Britannicus* are five, namely, *H. carnos*a, the first imported, and perhaps the best, anno 1802; *lanceolata*, *crassifolia*, *Pottsii*, *trinervis*, at periods between 1814 and 1825. They are natives of Asia, chiefly of China.

The flower of *Hoya carnos*a is white, tinted with pink, and a little yellow; the crown being blotched with vivid crimson; the flowers—twenty to thirty—are produced upon processes, which, at first, appear like simple peduncles, with swollen points, the germs of the future inflorescence. These arise from the stem, between the thick, coriaceous leaves, gradually enlarge, flatten, and develope, each, a perfect corymbose umbel of blossoms. When the flowers fall off, the processes remain elongate, and continue the permanent organs of inflorescence: every succeeding cluster, however, is produced at the point of the flower-stalk, leaving the receptacles of the previous cluster in the form of a rough burr, which acquires length in proportion to the numbers of corymbs that it has supported.

The odour of the blossom is highly fragrant, but very peculiar; and, therefore, disagreeable to some persons.

The plant is hardy enough to support the low temperature of the greenhouse; but it ought to be placed in the stove, or vinery. Nothing can be more easy of cultivation: cuttings strike freely; and the plants grow well in simple loam, or in rich composts: we, therefore, do not dwell upon these particulars, it being our principal object to detail some very interesting circumstances which came under our observation very lately; it is probable, however, that others have noticed the same facts; but they have not, to our knowledge, been publicly communicated.

The *Hoya* will live, grow, and flower in very small pots: it will prosper pretty well with either a liberal or scanty supply of water; but it appears to luxuriate in a bed of earth: hence we recommend, if it suit local convenience, that, when a plant has filled its pot, it be sunk into the ground or border within the stove, close to a wall; or, if cultivated in a conservatory, at the foot of some pillar, or trellis-work, up which it may be trained. The roots will pass through the hole of the pot, and speedily ramify in the soil. The ball may be turned out entire, and planted in the border, with the earth of which a small portion of lime rubbish may be incorporated; but in this case the plant becomes a fixture; whereas if the pot be plunged, it may be safely removed without causing any serious check.

The most interesting circumstance to be mentioned is the following. A fine young plant, that had rapidly produced three stems, each nearly two yards long, and many floral processes, was kept in a small pot (a 48) of loamy earth, which it had filled with roots. The pot stood on a shelf at the end of a stove, formed of 12-inch paving tiles, built into the wall, and little more than eighteen inches above the flue at its entrance. The stems were trained on rods along the end light, and it could not be readily moved, although the situation was found too hot for the soil, which rapidly became dry. To obviate this inconvenience, a quantity of moss was placed under the pot, and on the shelf, to some distance from it; and this was

now and then moistened. The growth and verdure were speedily assisted; and the plant flowered well in the late summer: upon attempting to remove the pot, it was found to be firmly fixed; the roots having penetrated and passed through the moss, and fastened themselves to the tile, on which they branched most extensively. Little or no moisture could be discerned on the tile, nor had the roots extended beyond the limits of the moss; but, *under* it, they were astonishingly numerous, and adhered as firmly to the tile as does ivy to a wall. Does not this circumstance tend, among many others, to throw some light upon the fact that cuttings emit roots more freely when they are placed against the sides of a pot; and that water alone is sufficient to furnish nutritive food to a variety of plants?

FOOD OF PLANTS.

THE food of animals always consists either of other animals, or vegetables, or a mixture of both, together with water, or some fluid containing a considerable proportion of water, for drink; that is, as a solvent to the more solid matters. Plants again, strictly speaking, subsist on drink alone, being indeed incapable of taking up any solid matter, at least till it be previously dissolved or diffused in water.

There is an obvious and well-known proof that plants live on water chiefly, if not altogether, derived from hyacinths and other bulbs placed in glasses, and supplied with water, in which they blow as well as in a garden. It is found, however, that they do not thrive unless the water is regularly changed, indicating that it is not the water alone, but something in the water, which becomes exhausted and deteriorated by the feculent slime discharged by the plant. It has also been found by experiment, that distilled water will not support a healthy growth in plants; and most, if not all species, when planted in pure calcined sand, and watered with distilled water, quickly die, as they do when quite deprived of water.

From chemical analysis and experiment, it appears that the chief matters taken up by plants, besides water, consist of carbonic acid gas and azote, together with a few salts, such as potass; and out of these, and the hydrogen and oxygen of the water, all vegetable products seem to be wholly or chiefly elaborated.

M. Lassaigue proved that these all pass into the plant from without, by the ingenious experiment of analysing the chemical constituents of seeds before and after germination.

When by chemical experiment substances are found in plants different from those supposed to have been introduced from the soil, it is not to be inferred that the plants have created these, but that they have gradually taken them up in very minute portions, till a considerable quantity has been produced.

It is proper to confess, however, that we are still much in the dark upon this interesting subject, it being extremely difficult, if not impossible, to trace the fluid taken up by a plant after it passes beyond the surface.—*Alphabet of Botany*.

NEW AND RARE PLANTS,

FIGURED IN THE THREE LEADING PERIODICALS FOR OCTOBER, NOVEMBER,
AND DECEMBER.

BOTANICAL REGISTER. Edited by Dr. Lindley, each number containing eight figures ; beautifully coloured 4s., plain 3s. ; and corresponding letter-press.

BOTANICAL MAGAZINE. Edited by Sir William Jackson Hooker, LL.D., &c., each number containing eight figures ; beautifully coloured 3s. 6d., plain 3s. ; and corresponding letter-press.

BRITISH FLOWER-GARDEN. Edited by David Don, Esq., Professor of Botany in King's College, London, each number containing four plates ; coloured 3s., plain 2s. 3d., and corresponding letter-press.

Of the above figures, we have only selected such as are new and rare ; and amongst these, only such as deserve to be extensively cultivated. For descriptions and figures, reference must be made to the works themselves.

CLASS I.—PLANTS WITH TWO COTYLEDONS (DICOTYLEDONEÆ).

ROSACEÆ (THE ROSE TRIBE).

ROSA LUTEA ; var. PLENA. Williams's Double Yellow Briar. A very interesting variety, forming an erect bush several feet in height, sending forth plenty of root-shoots, and producing full fragrant double yellow or sulphur-coloured flowers. It was raised about ten years ago by Mr. John Williams, of Pitmaston, near Worcester, from seeds obtained from the single yellow rose, which but very rarely matures its fruit in this country. Mr. Williams describes this variety as one of vigorous growth, and from its flowering freely, the size, form of its blossoms, it may be looked upon as making a valuable addition to our hardy collections of roses. It flowers in June, and may be increased by layers, or by being budded upon stocks of our native roses. *Brit. Fl. Gard.*, 353.

SOLANEÆ (THE NIGHT-SHADE TRIBE).

NIEREMBERGIA PHÆNICEA ; var. ROSEA. Pink-flowered Nierembergia. Certainly a pretty hybrid obtained, as a great many more have been, between *N. Phœnicea* and *nyctaginiflora*. The present variety was raised by Mr. Rodgers, of Battersea, and, like others of this group, it grows and flowers freely in the open border, and is readily increased by cuttings. *Brit. Fl. Gard.*, 354.

SCROPHULARIACEÆ (THE FIG-WORT TRIBE).

PENTSTEMON HETEROPHYLLUM. Various-leaved Pentstemon. A very interesting and pretty species of this valuable genus ; seeds of which were collected in California, by Mr. Douglas, and by him transferred to the London Horticultural Society. It is a hardy herbaceous plant, producing an abundance of pale purple blossoms from June till October, and may be propagated both from cuttings and seeds. *Bot. Reg.*, 1899.

LEGUMINOSÆ (THE PEA TRIBE).

CYTISUS ÆOLICUS. Æolian Cytisus. A new, and certainly pretty species, discovered in Stromboli, by Professor Gussone, and raised by the Hon. W. F.



THIS PAGE IS LOCKED TO FREE MEMBERS
Purchase full membership to immediately unlock this page



Never be without a book!

Forgotten Books Full Membership gives universal access to 797,885 books from our apps and website, across all your devices: tablet, phone, e-reader, laptop and desktop computer

A library in your pocket for \$8.99/month

Continue

*Fair usage policy applies

IRIDACEÆ (THE CORN-FLAG TRIBE).

LAPEYROUSIA ANCEPS. Two-edged Lapeyrousia. An uncommon yet well-known Cape plant, with a pretty modest aspect and a delicate delightful perfume. It may be cultivated in the greenhouse, or in a cold frame; well drained in winter, exposed to the warm and bright south in summer. It flowers in June and July, and ripens its seed about October. The sample of the drawing was furnished by John Rodgers, Esq., Jun., of Streatham, a lover and successful cultivator of Cape plants. *Bot. Reg.*, 1903.

The Periodicals for November contain:—

CLASS I.—PLANTS WITH TWO COTYLEDONS (DICOTYLEDONEÆ).

(BEGONIACEÆ).

BEGONIA FISCHERI. Dr. Fischer's Begonia. A species more remarkable for the beauty of its leaves (which are a bright red behind) than any striking feature in the flowers; these are small and of a whitish colour. It was sent from Berlin to the Edinburgh Botanic Garden in 1835, where it flowered in the stove in February and March, 1836. *Bot. Mag.*, 3532.

CRUCIFERÆ (THE CRUCIFEROUS TRIBE).

VESICARIA GRACILIS. Slender-stemmed Vesicaria. An interesting and singular plant, native of Texas, discovered by Mr. Drummond. It has a remarkably slender stem, and produces a great number of yellow flowers, which give it a lively and graceful appearance; and being an annual, it is well adapted for rock-work. *Bot. Mag.*, 3533.

LOASEÆ.

BARTONIA AUREA. Golden Bartonia. A pretty annual, loving a sunny situation and rich soil; when so treated, it will be found to grow luxuriantly, producing a succession of its golden blossoms, and perfecting its seeds freely. It flowers in the open border about the middle of May. *Brit. Fl. Gard.*, 357.

BERBERACEÆ (THE BERBERRY TRIBE).

EPIMEDIUM MACRANTHUM. Large-flowered Epimedium. A very pretty sweet-scented species, remarkable for the large size of its pale violet flowers. Dr. Lindley thinks it will prove hardy, and quite worthy the notice of all lovers of curious plants. It was imported from Japan. *Bot. Reg.*, 1906.

CLASS II.—PLANTS WITH ONE COTYLEDON (MONOCOTYLEDONEÆ).

ORCHIDÆ (THE ORCHIS TRIBE).

EPIDENDRUM MACROCHILUM. Large-lipped Epidendrum. A charming epiphyte, introduced from Mexico by Charles Horsefall, Esq. The sepals and two upper petals are of a greenish brown, while the lip is pure white, changing to cream colour in age, having a red purple spot at the base, where there is a flattened disk, and another near the middle. *Bot. Mag.*, 3534.

IONOPSIS TENERA. Delicate Ionopsis. A delicate yet pretty species, brought from Havannah in March 1835, by Captain Sutton, of Flushing, near Falmouth, and presented to Sir Charles Lemon's collection at Carclew, where it flowered in May last. The flowers are of a pale pink colour. *Bot. Reg.*, 1904.

ASPASIA VARIEGATA. Variegated Aspasia. An interesting and desirable species, a native of the tropical part of S. America. The flowers are prettily variegated, and in the morning deliciously sweet; it will probably prove easy of cultivation, therefore should be in every collection. *Bot. Reg.*, 1907.

ONCIDIUM IRIDIFOLIUM. Pigmy Oncidium. The most interesting species of Oncidium that we have seen. In the absence of the flowers, the plant might be mistaken for one of the *Pleurothallises*, so much does it resemble the species *picta* of that genus. It grows, including plant, scape, and flowers, about three inches high, forming a dense tuft of green foliage, from among which arise an abundance of flower spikes, many bearing two flowers of a yellowish colour. Dr. Lindley says, it seems to be common in the hotter parts of America, and it has been observed growing upon the branches of orange and lemon trees, constantly preferring dry places exposed to the sun. In the rich collection of Orchideæ, at Wentworth, it flowered in August, 1835. *Bot. Reg.*, 1911.

The Periodicals for December contain:—

CLASS I.—PLANTS WITH TWO COTYLEDONS (DICOTYLEDONEÆ).

THE VERVAIN TRIBE (VERBENACEÆ).

VERBENA LAMBERTI; var. ROSEA. Drummond's pink-flowered Vervain. A very pretty variety with pale pink flowers; and, as represented in the plate, each flower is furnished with a striking eye in the centre, formed by a circle of rich pink surrounding the mouth of the nearly white tube, which renders it pleasing and conspicuous. It is a hardy free-flowering highly fragrant perennial. Mr. Don remarks, that little difference exists between this variety and *V. Drummondii*, and *V. Aubletia*. *Brit. Fl. Gard.*, 363.

VERBENA TWEEDIEANA. Mr. Tweedie's scarlet Vervain. This species is said to surpass in beauty the long and justly admired species that has so long stood before, for brilliancy of colours, almost every other plant in the flower-garden, viz., *V. chamædifolia*, or *melindris*. It is a tall upright-growing plant, producing, at the extremity of the strongest shoots, a dense conical-shaped head of brilliant crimson flowers. It was introduced by Mr. Tweedie, to the Glasnevin Botanic Garden, and flowered about September, 1836. It has hitherto been treated as a stove-plant, but it will, probably, turn out quite hardy. *Bot. Mag.*, 3541.

THE BEAN TRIBE (LEGUMINOSEÆ).

GENISTA MONOSPERMA. Single-seeded Genista. Dr. Lindley allows this to be one of the most deliciously fragrant shrubs in the world. It is difficult, he says, to imagine anything more delicate and grateful than the sweet odour that its tender and snow-white blossoms diffuse in the conservatory, in the months of May and June. It is found along the basin of the Mediterranean, and is described as being, when wild, a good deal taller than a man; having a trunk an inch thick, and waving its green-gray leafless thread-like branches in the wind, in the most graceful manner. It is multiplied by seeds and cuttings, and must be treated as a greenhouse plant in winter. *Bot. Reg.*, 1918.

THE PROTEA TRIBE (PROTEACEÆ).

BANKSIA OCCIDENTALIS. West-coast Banksia. This is a very handsome species; the reddish purple-spreading horizontal styles, tipped with yellow pollen, give it a very singular, yet rich appearance. It flowered in the greenhouse of the Edinburgh Botanic Garden, in September, 1835. Like other species of the genus, it requires great care in the cultivation. *Bot. Mag.*, 3535.

IPOGON BAXTERI. Mr. Baxter's Isopogon. This is another very handsome species of the natural order *Proteaceæ*. The flowers, which are crowded at the termination of the stem and branches, contrasted with the thistle-like green leaves, render the plant very gay and desirable. It is a New Holland species, consequently must share the treatment of the greenhouse. *Bot. Mag.*, 3539.

THE SUNDEW TRIBE (DROSERACEÆ).

DROSERA FILIFORMIS. Narrow-leaved Sundew. We are pleased to have the opportunity of noticing another species of this very interesting genus. The species figured by Dr. Hooker, in the Botanical Magazine, was found by Mr. James Macnab, in a swamp about ten miles above Tuckerton, New Jersey, United States, and introduced by him into our gardens in 1834. Unlike our native species, *Drosera rotundifolia*, this has long narrow leaves; but, like it, the glands upon the upper face exude a viscid juice, no doubt capable of entrapping and holding insects that may incautiously alight upon them. The scape is lateral and simple, and the flowers at its summit of a rose colour. Dr. Neile, who flowered it well, kept the plant in a stove heat. *Bot. Mag.*, 3540.

CLASS II.—PLANTS WITH ONE COTYLEDON (MONOCOTYLEDONEÆ).

THE ORCHIS TRIBE (ORCHIDEÆ).

BRASAVOLA CORDATA. Heart-lipped Brasavola. A species of orchidaceous plants, closely allied to *B. nodosa*, from which it differs in its flowers, being only half the size, with a cordate labellum, and a very different clinandrium. A native of Brazil, flowers in January. There will, observes Dr. Lindley, be no certainty in the cultivation of epiphytal Orchidaceæ, till we become more precisely acquainted with the habits of the different species than we now are. At present, it is usual to consider them all natives of trees in damp shady woods. It is, however, quite certain that such is the habit of only some of them. The whole genus, *Brasavola* for example, grows upon stones and rocks, never upon trees, in open forest glades, fully exposed to the sun. *Bot. Reg.*, 1914.

THE CORN-FLAG TRIBE (IRIDACEÆ).

SYSYRINCHIUM GRAMINIFOLIUM; var. PUMILUM. Dwarf grass-leaved Sysyrrinchium. A very beautiful, and certainly a desirable, little perennial, with bright yellow flowers. It is a native of Valparaiso and Conception, where it flowers in October. With Robert Mangles, Esq., the gentleman who furnished the sample for the drawing, it flowered about May. It must be treated as a greenhouse plant. This, remarks Dr. Lindley, is one of those perennials with succulent, fingered roots, which multiply sparingly. It is chiefly to its seed that we must look to the means of propagating it. *Bot. Reg.*, 1915.

NOTICES OF NEW AND RARE PLANTS

IN FLOWER IN THE LEADING NURSERIES AND PRIVATE GARDENS IN THE VICINITY OF LONDON.

MESSRS. LODDIGES, HACKNEY. *Rondeletia odorata*, a new and beautiful stove plant (the flowers of which are of a bright scarlet, with a little yellow in the centre), is now in flower, and is well worthy of a place in every collection. There are several fine *Orchideæ* now in flower, viz., *Cattleya guttata*, *Eulophia cochleata*, *Dendrobium densiflorum*, a new species of *Oncidium* with pink flowers, and a new species of *Bolbophyllum*, similar in growth to *B. careyanum*, but the flowers are of a dark chocolate colour. There are also two extraordinary large specimens of *Testudinario elephantipes*, which Messrs. Loddiges have recently imported from the Cape.

MR. LOW'S, CLAPTON. *Euphorbia Jacquinaeflora*, a rare and splendid scarlet flowering stove plant, is now in flower. Also a fine plant of *Camellia Donkellaera*, which is literally covered with flowers; this is deservedly esteemed as one of the best known species of this extensive and valuable genus. *Lobelia persicifolia*, an old but rare species of *Lobelia*, has recently flowered at Mr. Low's, and is worthy of notice, not only on account of the beautiful scarlet colour of its flowers, but because it is a shrubby species.

MR. KNIGHT'S, CHELSEA. *Pentstemon latifolium*. This new and beautiful species has recently flowered in the above-named nursery, and merits a place in every collection, as it produces its flowers so very abundantly, and continues in flower for a great length of time; also a very fine variety of *Primula sinensis*, the flowers of which are considerably larger than the original species, and much darker in colour. Mr. Knight has several newly-imported species of *Sarracenia*, which have not yet flowered, but among which he expects to have some very good new ones.

MESSRS. ROLLISON'S, TOOTING. *Epidendrum Skinneri*. This new and highly beautiful Orchideous plant, which has pink flowers, has been in flower for several weeks, and still remains so, and on this account, as well as the striking beauty of its flowers, no collection of this much-admired tribe of plants should be without it. *Oncidium leucochilum*, a new species of *Oncidium*, is now in flower, and, with the exception of *O. lanceanum*, is equal in beauty to any other known species of this peculiarly interesting genus; the outer sepals of the flowers are of a light green-coloured ground and beautifully spotted with brown spots; the lower lip (*labellum*) is white, from whence it derives its name. There is a remarkably fine plant of *Clianthus puniceus*, which is showing flower very abundantly, and from the well-known beauty of this plant we should judge that this specimen, when in flower, will be surpassingly beautiful.

MR. YOUNG'S, EPSOM. *Luculia gratissima*. This beautiful plant, which is now flowering in great abundance at the above-named nursery, seems to require a situation between the heat of the stove and that of the greenhouse, and is valuable as it flowers at the season of the year when flowering plants are most wanted in our conservatories and stoves, and more particularly as it is a remarkably free-growing as well as free-flowering plant, and is also delightfully fragrant. *Kennedia nigricans*

and *K. Marryatti* are showing flower, and are both rare as well as beautiful species, and are deserving of notice not only on account of the beauty of their flowers, but as the foliage is remarkably fine. *Gesneria oblongate*, which has been in flower for several months, is still covered with flowers, and to all collections of stove plants this would be a decided acquisition; it has bright scarlet flowers, but, unlike some of the other species, the mouth of its tubular corolla expands all round, and is beautifully spotted with dark brown spots.

NOTICES ON THE CULTURE OF NEW AND RARE PLANTS IN THE PRINCIPAL PRIVATE GARDENS AND NURSERIES IN THE VICINITY OF LONDON.

ON grafting *Epiphyllum speciosum* and *E. Ackermannii* on *Cereus speciosissimus*.—Having in a former number of the Magazine noticed the complete success with which Mr. Green, gardener to Sir E. Antrobus, Bart., grows the different species of *Cacti*, and his usual method of growing them; and having since become cognizant of another interesting fact relative to the principles of grafting which Mr. Green adopts, we now proceed to lay it before our readers. Every person that is at all acquainted with this beautiful tribe must be well aware that the stems of *Cereus speciosissimus* are much stronger and more succulent than those of *Epiphyllum speciosum* and *E. Ackermannii*, and consequently contain more nourishment. Acting upon this theory Mr. Green takes plants of *C. speciosissimus* in the early period of their growth, and as they usually throw three, four, or more stems from the root of the plant, he divests them of all but one, taking care to leave the strongest and most healthy one remaining, which is then trained up to a stick quite erect, till it has attained the height of between two and three feet; he then takes cuttings of the two before-named species of *Epiphyllum*, and, commencing about two feet from the bottom of the stem thus prepared, places grafts round it at two or three inches from one another indiscriminately till he reaches the top: while he thus places both the above-named species on one plant, he has other plants on which he places grafts of only one of the species, which constitutes a pleasing variety; the plants thus grafted upon will, in the course of a year or two, make beautiful heads, and the grafts, owing to the superior nourishment derived from the plants on which they are grafted, will grow much more luxuriantly, flower more abundantly, and the flowers will be nearly twice as large. Mr. Green has several very fine plants treated in this way, which, even when they are not in flower, have a very imposing appearance, and no doubt, when in flower, they are surpassingly beautiful. From the great success attending this method of treating these two species, there can be little doubt but that *Epiphyllum splendidum*, *truncatum*, *alatum*, and others that have weak and flat stems, would do equally well under the same treatment; and we think, if this system were more generally adopted, it would contribute greatly to enhance the value of this highly beautiful and much-admired tribe of plants.

Wistaria consequana. This beautiful plant, which is now becoming so common an ornament of our greenhouses, verandahs, and garden walls, will nevertheless still be considered worthy of a situation in every collection, on account of its flowering so early in the spring, and the flowers being so very beautiful and fragrant, and we have

no doubt that any method of making it flower more abundantly would be well received by our readers. Mr. Knight, of Chelsea, has a simple method of causing this plant to flower three times in the year by the following treatment:—After the first flowering is over, which will be about the latter end of May, he strips off all the leaves, and cuts off all young and superfluous shoots which have been formed to within a few eyes of the stem, which causes it to throw out fresh leaves, and to flower again in the months of July and August, and after this flowering is over the same process is repeated of cutting off the leaves, and this causes it to flower again in the months of October and November; it may be said that this plant will naturally flower twice and sometimes thrice in the season, but when it does (which is but very seldom) the flowers are so very weak, and there are so few of them, that it is never worth notice; whereas by the above simple process an abundant succession of flowers may be ensured throughout the whole season. It should be remembered that these remarks will not apply to *young* plants, but only to those that are well established.

OPERATIONS FOR FEBRUARY.

THIS is an important season with the practical gardener, amateur, and florist; it is now that these in their respective vocations are called to give play to their thinking faculties; now they must deliberately and judiciously exercise their powers of consideration upon what is required to be brought into effect in the approaching season; for each clearly conceives his whole success, in an important degree, to depend upon the arrangement made in this and the succeeding month or two. He no sooner becomes conscious that spring is rapidly advancing than he finds a combined train of operations crowding upon his mind; to each of these he must assign the most suitable season for carrying into effect; and of every individual performance he perceives it necessary to possess a clear idea, or he will, when the season arrives in which such and such things are expected to be in their greatest perfection, find that he is much behind his neighbours, and himself sadly disappointed. It is, therefore, of the utmost importance to set about this matter in time, for it is not with the gardener as with the operative in other arts. The mechanic may work out a given design to a month or a day, or if he wished, by calling more strength into action, he can accomplish the same in even less than half the time; but it is different with the practical gardener, for, whether much or little strength, he cannot induce Nature to move out of her ordinary pace; no, she must have time, when, if duly tended, all reasonable expectations will be favoured.

Many things have to be thought about as to how the flower-garden is to be filled with flowering plants; how these are to be disposed of to keep up a succession of bloom, and at the same time produce an agreeable and varied appearance; what new annuals, or other plants, have made their appearance since last season; of these which are worth purchasing. The greenhouse, stove, &c., demand in turn their share of consideration; many, if not all the plants, will soon require examining or shifting; others pruning; others inarching; others propagating, and seeds of other kinds it will be necessary to sow; and what is still of greater moment is the

growing season, and the different treatment required by certain families of plants during that time; some will require a good deal of water, while others will be killed if watered above moderation; light and shade are preferred, more or less, by some; this is a weighty affair, and should be early considered of: besides the gardener's forebodings must extend to the pleasure-ground, and an infinite number of other little matters are to be thought of, and performed; all of which judicious and timely consideration will conduct to the most satisfactory results.

ALOES should at this season be cautiously dealt with, or they will receive injury from immoderate watering. It is also necessary to treat in this respect with especial care all succulent plants; keep them rather dry, giving air when the weather will admit of so doing, and they will be in a good state for starting when the growing season commences. Succulent and other plants, in rooms, should now be kept moderately dry, and have as great a share of light and air admitted to them as is practicable, otherwise they will draw and become delicate.

ALONSOA. The plants of this genus have a pretty appearance in the flower-garden in summer when in bloom. It is, therefore, advisable to have plants in readiness for turning out when wanted. They increase readily from cuttings or seeds. All young stock propagated last autumn must now be carefully attended to, and propagation carried on with those kinds most wanted for setting off the flower-garden next summer.

AMARYLLISES, and other bulbous plants that have been dormant during winter, will now be on the move; attend, therefore, duly to such.

CALCEOLARIAS. Young plants of this genus never do better in any situation, at this season, than in a cold frame, taking care to lay an efficient strata of drainage at the bottom before introducing the pots. If the weather be open they may now safely be put into a frame of this description, observing to guard against frost by timely protection; water and pot them cautiously, and give plenty of air on fine days.

CAMELLIAS in the forcing-house, or rooms, should be encouraged by gentle watering, and careful exposure to the light and sun, when the latter is available.

GESNERIA and **TROPÆLUM** bulbs that have been kept dry during winter may now be gently brought into action; pot and water carefully, and they will come on prettily.

GLOXINIA *speciosa*, *hirsuta*, and *candida*, will now be starting, as will *Begonia Evansiana* (*discolor*), &c. Give all such immediate and judicious encouragement.

IPOMOPSIS ELEGANS, sow about the beginning of this month, and the plants will flower freely in autumn.

MIMULUSES, esteemed and tender kinds, should now have an abundance of pot-room and water, and they will soon flower if placed in a light situation in the greenhouse, or cool peach-house, pit, or vinery.

PREPARE SOIL, DRAINAGE, &c., for shifting *Orchideæ* and other stove-plants. Stakes of various sizes, labels, &c., should be in readiness.

SHRUBS, BULBS, &c., in the forcing-house, must be attended to; fumigate with tobacco *Roses, Pinks, &c.*, when necessary. Secure a succession of popular and free-flowering kinds. *Bulbs* in glasses, &c., require fresh water frequently.



THIS PAGE IS LOCKED TO FREE MEMBERS

Purchase full membership to immediately unlock this page

DELVE INTO FANTASY, MAGIC, MYTHOLOGY & FOLKLORE

Forgotten Books'
Full Membership gives
access to 797,885 ancient
and modern, fiction and
non-fiction books.

Continue

*Fair usage policy applies



Olden del. - Smith sc.

Lissochilus speciosus

MARCH 1837



LISSOCHILUS SPECIOSA.

(MR. GRIFFIN'S SHOWY LISSOCHILUS.)

CLASS.
GINANDRIA.ORDER.
MONANDRIA.NATURAL ORDER.
ORCHIDEÆ.

GENERIC CHARACTER.—*Pollen masses* two, obliquely two-lobed. *Lip* seccate at base, sessile undivided, convex at the base, united with the apterous toothless column. Inner sepals divaricating, petaloid; outer reflexed, calycine. ENCY. OF PLANTS.

SPECIFIC CHARACTER.—A terrestrial bulbous species, growing more than two feet high. *Leaves* stiff, linear, lanceolate, smooth, of a deep green. *Scape* arising from the under side of the newly formed bulb, many-flowered. *Flowers* alternate, springing from the axilla of a lance-shaped green bractea, spreading, of a beautiful yellow colour, very showy.

THIS beautiful feature of the terrestrial portion of orchideous plants, was introduced from the Cape of Good Hope, by Mr. Griffin, in whose hot-house at South Lambeth, some time after, it produced its very showy yellow flowers. The accompanying representation was taken from a very fine plant in the possession of Mr. Faulkner, of Manchester, in whose collection of celestial and terrestrial Orchideæ, it produced its rich blossoms in the autumn of 1835.

This species, which is cultivated with the most perfect success in the collection of our respected contributor Mr. F., especially merits the attention of all lovers of orchideous plants; the flowers in general begin to open at the lower part of the scape about May or June, and continue to expand upwards in succession until the latter end of July, or the middle of August, during which time the most lively interest is kept up in the orchideæ house, by the contrasted colour of its bright yellow blossoms with the deep green foliage of other surrounding species of this natural family.

It will thrive in a temperature much below that in which orchideous plants in

general delight, but will not succeed well with the treatment of green-house plants, unless the house in which they grow is kept at a higher temperature than is usually recommended or suitable for them. One intermediate between these will suit it. It prefers good rich loamy soil, mixed with a little peat and sand ; it should be put into a well drained pot, not over large, and the plant in summer liberally watered, but in winter it should scarcely have any. It is propagated by dividing the bulbs. The generic name alludes to the smoothness of the lip, and the absence of swellings or crests from that part. The specific name *speciosa* applies to the showy character of the flowers.



E. W. Smith. Del. et sc.

Gesneria Selkowi.

MARCH 1837



THIS PAGE IS LOCKED TO FREE MEMBERS
Purchase full membership to immediately unlock this page



Never be without a book!

Forgotten Books Full Membership gives universal access to 797,885 books from our apps and website, across all your devices: tablet, phone, e-reader, laptop and desktop computer

A library in your pocket for \$8.99/month

Continue

*Fair usage policy applies

GESNERIA SELLOI.

(DR. SELLOW'S GESNERIA.)

CLASS.
DIDYNAMIA.ORDER.
ANGIOSPERMIA.NATURAL ORDER.
GESNERIÆ.

GENERIC CHARACTER.—See Vol. I., p. 224.

SPECIFIC CHARACTER.—*Plant* herbaceous. *Leaves* opposite, nearly sessile, ovate, acutely serrated, pubescent. *Racemes* terminal. *Bracteas* ovate, acute. *Pedicles* about an inch long, of a reddish brown colour. *Corolla* tubular, pubescent, irregular, about three inches long, bright scarlet, the upper lip narrow, oblong, revolute, and bifid; the lower lip broad, trifid, and terminating bluntly. *Stamens* nearly as long as the corolla. *Anthers* cohering, two-celled. *Stigma* capitate, concave. *Ovarium* half superior. *Seeds* numerous.

THIS elegant stove plant is a native of the Brazils, and named after Mr. Sellow, a collector of plants for the Prussian government,—who sent it, with many others, to the Botanic Garden at Berlin. It is easily cultivated, taking care not to water over the bulb whilst in a dormant state, and then but very sparingly. It thrives in a mixture of sandy loam and peat.

It may be propagated by cuttings, or leaves, as *Gloxinia* and other plants of this order, and frequently produces seeds.

Dr. Lindley states it to be nearly allied to *Gesneria faucisulalis*, from which, however, it differs in brilliancy of colour and denser racemes. Mr. Knight, of the King's Road, Chelsea, furnished us with the plant.



Lupinus ulicina



THIS PAGE IS LOCKED TO FREE MEMBERS

Purchase full membership to immediately unlock this page

DELVE INTO FANTASY, MAGIC, MYTHOLOGY & FOLKLORE

Forgotten Books'
Full Membership gives
access to 797,885 ancient
and modern, fiction and
non-fiction books.

Continue

*Fair usage policy applies

in fine weather, and at no time should they be crowded amongst other plants. Cuttings of the half-ripened wood, planted in a pot of sand, without bottom heat, placed under a glass, root freely if not heavily watered. Any species in the genus may be grown and propagated in the same manner with the best success. No greenhouse should be without this handsome, and we may add interesting, plant.

Our often mentioned and much esteemed contributor, Mr. Bows of Manchester, furnished the sample for the drawing some time in the summer of last year.

The generic name is given in honour of the Reverend Hugh Davies, F.L.S., a Welsh botanist.

The specific name alludes to the resemblance of the leaves to those of furze.



Wils. Morrish del. — Smith sc.

Euphorbia fulgens.

M. R. C. H.

EUPHORBIA FULGENS.

(FULGENT EUPHORBIA.)

CLASS.
DODECANDRIA.ORDER.
TRIGYNIA.NATURAL ORDER.
EUPHORBIACEÆ.

GENERIC CHARACTER.—*Calyx* none. *Corolla* none. *Involucres* of many spreading leaves. *Flowers* naked, aggregate (collected together). *Female floret* enclosed by many (one-stamened) male florets.

SPECIFIC CHARACTER.—*Plant* stove shrub, growing from three to four feet high. *Stem* smooth, disposed to branch. *Leaves* smooth, lanceolate, entire, acuminate, those at the bottom of the branches of a dark green, while those at the upper part become tinted with a flame or light clouded red colour, as shown in the drawing. *Flowers* produced along the extremity of the youngest branches in axillary bunches, from three to four in each bunch, of a rich brilliant scarlet.

THIS beautiful and rare species of Euphorbia has not, to our knowledge, been before published in any periodical in this country; nor are we aware of it having flowered in any collection except that of Messrs. Lewcombe, Pince, & Co., of Exeter, from whence we were kindly furnished with the accompanying delineation from the pencil of Miss Morrish of that city. We have not had an opportunity of examining the plant in detail, but it appears to us sufficiently distinguishable from all the species hitherto described by the striking difference in the colour of the leaves; those of the lower part of the branches being of a dark green, while those which terminate the shoots are shaded with pink, or a bluish colour, or mottled with a faint blue upon a purplish ground. The plant is a native of Mexico, and has been cultivated by the above nurserymen in their extensive and rich collection of stove exotics for two years; but on account of the smallness of the plant it did not produce its flowers until the commencement of November last, at which time, by the brilliant colours of the flowers and their profuse number, the appearance was truly splendid. To convey a better idea of its appearance when in full blossom we have only to add that in general effect it greatly surpasses the well known

E. splendens, even when in its highest perfection. In the stove it thrives best in a temperature varying from 70 to 75 degrees Fahrenheit, and potted in a mixture of very sandy heath-mould and loam, -liberally watered. The plants grow rapidly, and may be increased with facility from cuttings in sand.

The generic name *Euphorbia* is derived from Euphorbus, a physician to Juba, king of Mauritania, and said to have first used the plant in medicine.

The specific name *fulgens* applies to the splendour and brilliancy of the flowers.

The following remarks on this valuable and very desirable exotic were made by M. F. Rauch, during a gardening tour in Germany in the spring of 1836, and recorded in the Gardeners' Magazine for August, whence our extract.

“*Euphorbia fulgens* is an elegant and very ornamental plant, of the following characteristics:—It is a branched, upright, leafy, freely growing, and freely flowering shrub. All its green parts bear a glaucous bloom. Its shoots are slender, twig-like, round, glabrous, and curved outwards in their terminal portion; bearing the flowers along this portion in groups, in the axils of the leaves. The leaves have petioles nearly one inch long, and disks that are lanceolate, tapered to both ends, entire, about three inches long, and from half an inch to one inch across in the broadest part. The groups of flowers are upon short stalks, and consist of from two to four flowers (as they would be ordinarily called), each upon a stalk about one inch long; and each showy from its involucre, which is of a bright red colour, and which has a tube of less than half an inch long, and a horizontally spread border of a diameter somewhat less than that of a sixpenny-piece, and consisting of five obcordate lobes. One may imagine that a bush, abounding in groups of these involucre displayed together, must be splendid, and well merit the application of the epithet *fulgens*; which, however, the inventor of the name may rather have intended to express a brilliance in the redness, than the general effect produced by a display of flowers of this colour. This plant appears disposed to produce plenty of seeds.”



THIS PAGE IS LOCKED TO FREE MEMBERS
Purchase full membership to immediately unlock this page



Never be without a book!

Forgotten Books Full Membership gives universal access to 797,885 books from our apps and website, across all your devices: tablet, phone, e-reader, laptop and desktop computer

A library in your pocket for \$8.99/month

Continue

*Fair usage policy applies

of a pot, and moveable, to allow the fuel to be introduced at the top of the furnace.

The only peculiarities of this chimney, are a circular plate of strong iron, *c*, nearly as large as the opening of the furnace, suspended by three rods over the fire, and causing the flame to play against the sides of the boiler, the draft taking place all round it, and a deep rim of sheet iron about three inches broad, in form of an inverted cone, attached at its upper edge to the lid, but leaving a space of about one and a half inch between itself and the circular plate or damper. Through this space the draft plays as indicated by the arrows in fig. 1, where the top is represented in its place.

Fig. 3.

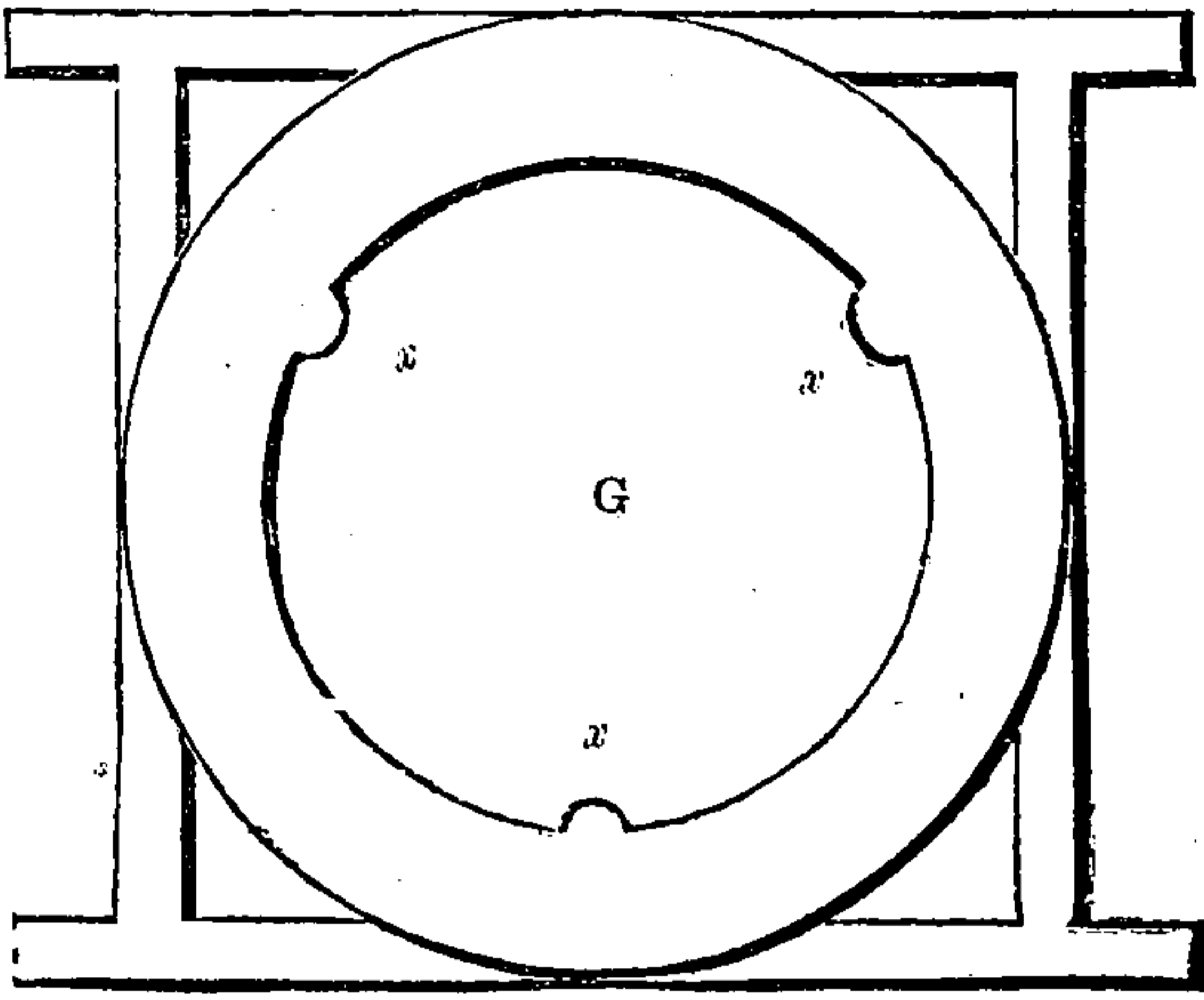

Fig. 3 represents the frame or base on which the boiler is fixed. A ring of iron rather broader than the bottom of the boiler is attached to a square frame of wrought iron, by which it may be fixed in the brickwork which supports it. The grate *G* may either rest on three brackets *x x x*, and be thrown down with an iron hook, or (which is the best plan) be fixed on pivots, with a catch to prevent it from turning over, except when required to clear the furnace.

Fig. 4.

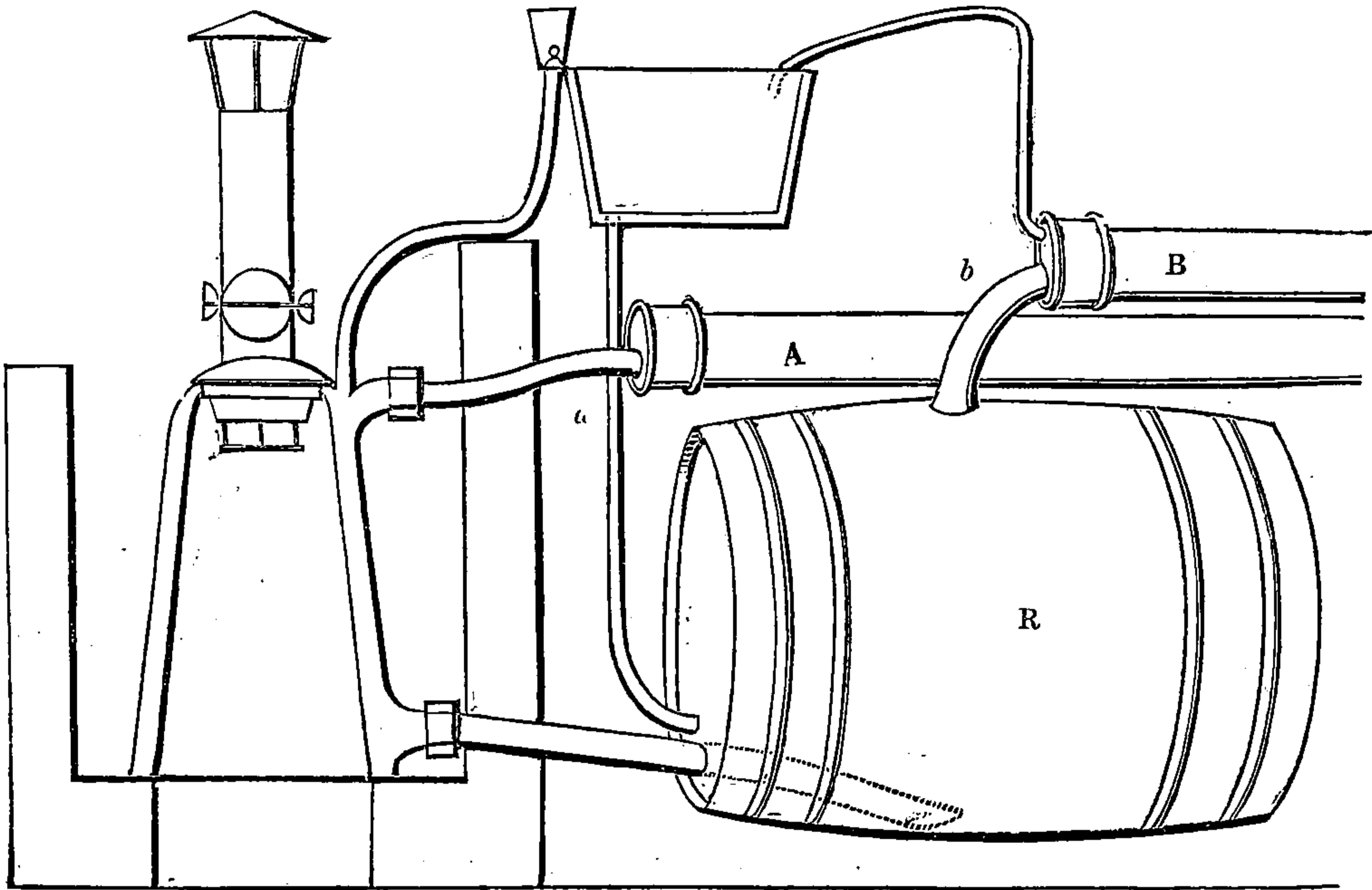

Fig. 4 represents the apparatus complete. The lead pipe *a* from the upper union joint of the boiler enters the lower side of the cast-iron pipe *A*; and from *B*, the other extremity of the range of iron pipes a lead pipe, *b*, also from the lower side of the iron pipe, enters the top of the reservoir *R*. A strong cask answers the purpose of a reservoir as well as any thing, though an iron tank, or close cistern of very thin copper, would be more durable. From the lower side of this reservoir

another lead pipe enters the union joint at the bottom of the boiler; at B, the highest point of the whole system of heating pipes, there is fixed on the upper side of the pipe a small air-pipe, whose other extremity is turned over into the supply cistern, so that any water casually thrown out there is returned into that cistern. The supply cistern, the bottom of which is not lower than the upper side of the pipe B, is placed over the reservoir, and communicates with it by a small pipe entering the reservoir at the bottom. The steam valve is placed just above the supply cistern, having a small basin or funnel round it, like those of the escape pipe of steam-vessel boilers, so that water thrown out, or condensed steam, may fall into the supply cistern. This escape of water or steam, however, can only take place when the water boils, which, if the boiler be properly proportioned to its work, can rarely take place. It is, however, a precaution which could not safely be omitted, though the danger of water being thrown out there is best obviated by loading the water with a small weight of two or three ounces, or a quarter of a pound on the square inch.

The apparatus being filled through the supply cistern, the water enters the reservoir and thence fills both boiler and pipes, the air escaping from B by the air-pipe, until the water standing in the bottom of the supply cistern indicates that all is full. The fire being then lighted, the heated water flows into the iron pipes, and thence into the reservoir, till all having received one change of heat, it passes again through the boiler, acquiring fresh heat till all is nearly boiling. When the fire declines, a counter current takes place, the hot water from the reservoir rises to the pipes, where as it cools it descends into the boiler, and thence into the bottom of the reservoir, till all be cool again—having rendered up its heat into the pit or house.

Fig. 5.

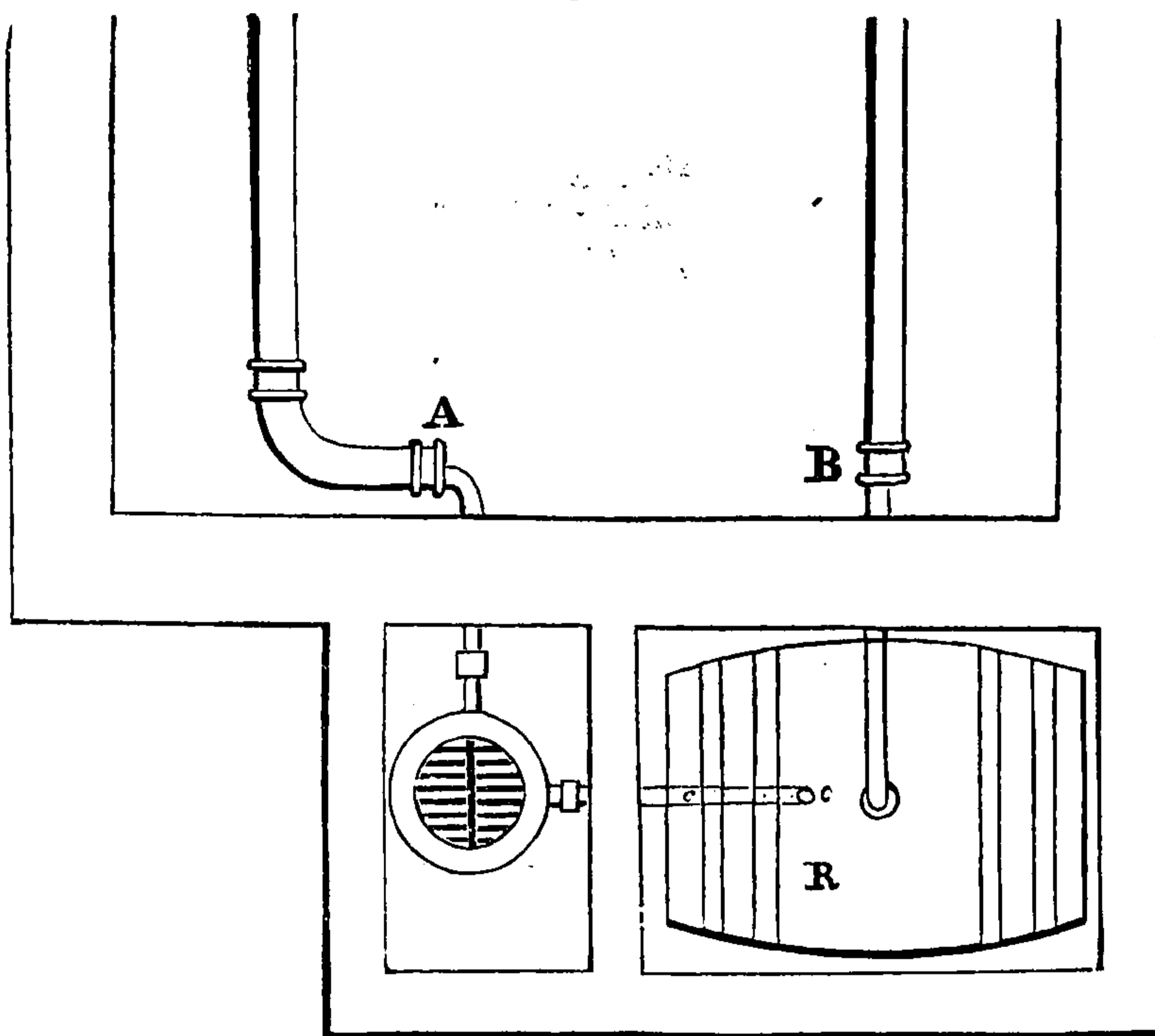

Fig. 5 is a ground plan of the most convenient mode of applying this apparatus to a pit. The boiler and reservoir are inclosed in a little chamber of brick-work,

and completely packed in dry sawdust, or some other non-conductor, to prevent the escape of heat. The reservoir may be covered with a little roof, and the space round the boiler with a sheet of lead or copper, or iron fitted round the top of the furnace. The supply cistern will be under the roof, save from front, the steam valve put outside the roof. The supply cistern should be large enough to allow for the expansion of the water in heating; about 1 gallon to every 30 in the apparatus will be enough. The boiler and reservoir, being outside the pit, are accessible in case of necessity or any accident.

Fig. 6.

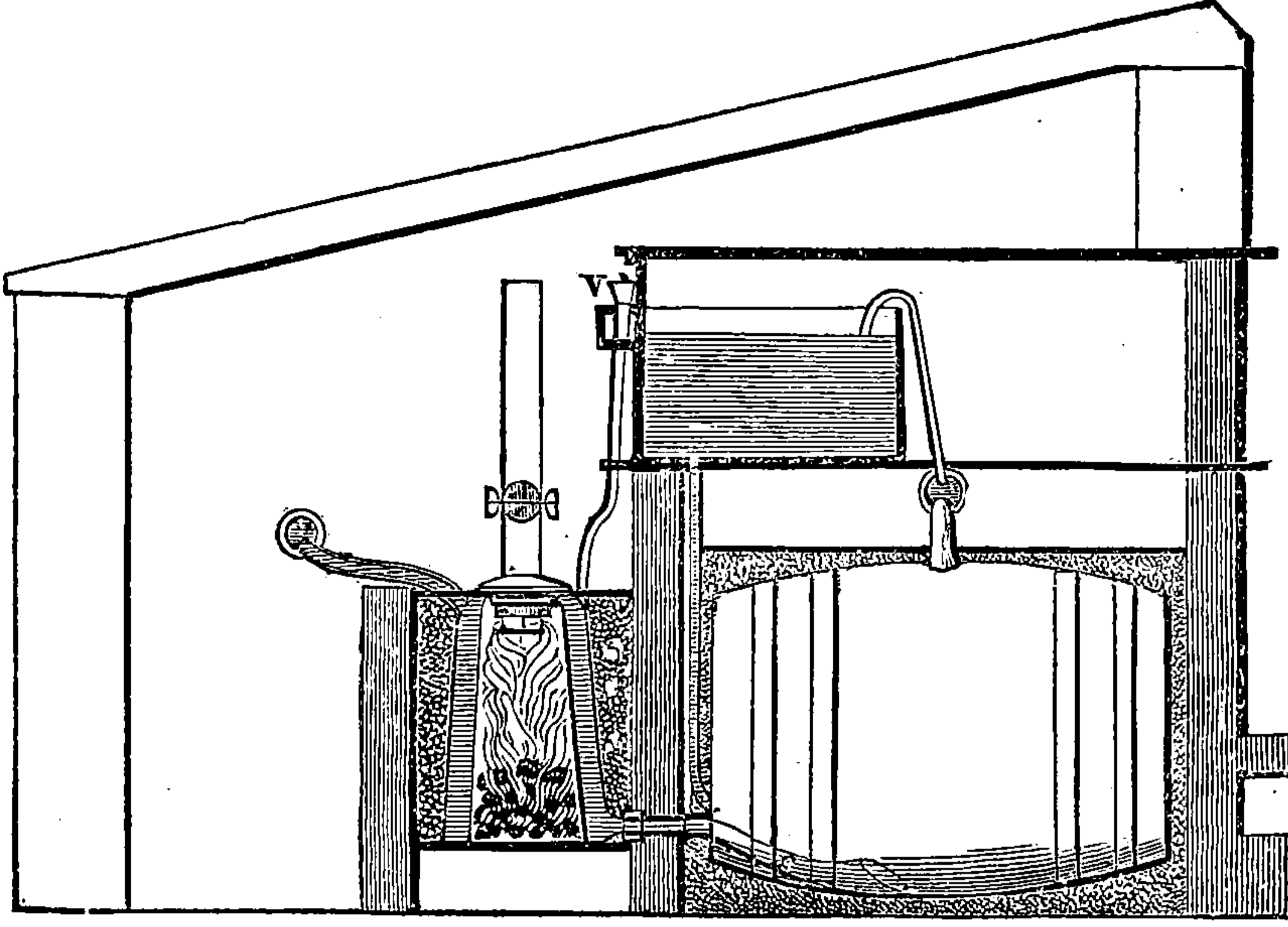

Fig. 6 is a section of Fig. 5, exhibiting the relative position of the boiler, reservoir, supply cistern, pipes, &c. It is not necessary that the foundation of the pit should be carried down as deep as that of the reservoir chamber and boiler; but it is convenient to have these deep, in order to get the pipes as low as possible, and have plenty of room for plants on the slate which lies over them; the lead pipe *c* is introduced through one end of the cask, instead of being attached to its lower side: by being made to extend to the bottom, it acts quite as effectually, and is more convenient to arrange.

Fig. 7.

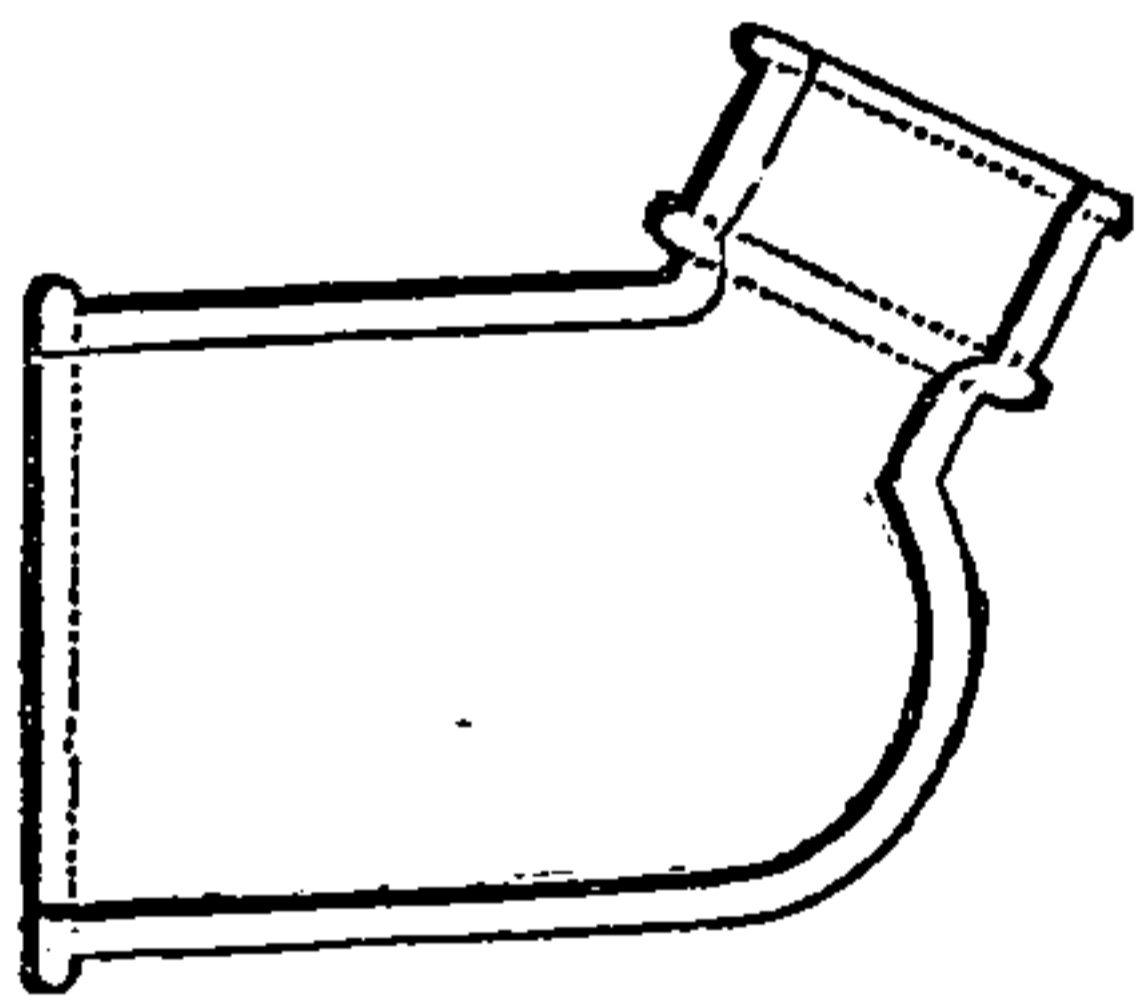

Fig. 3. No. 2.

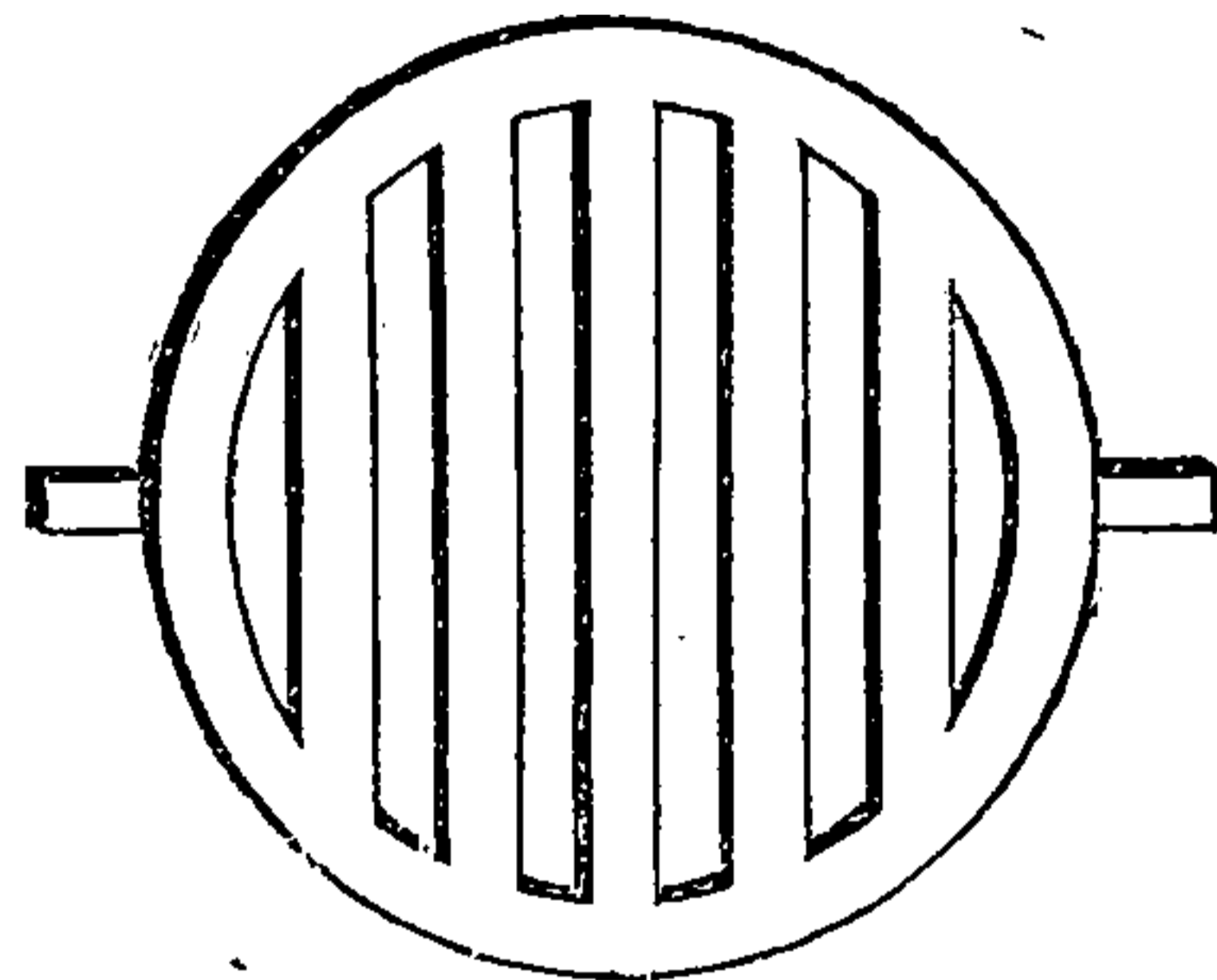
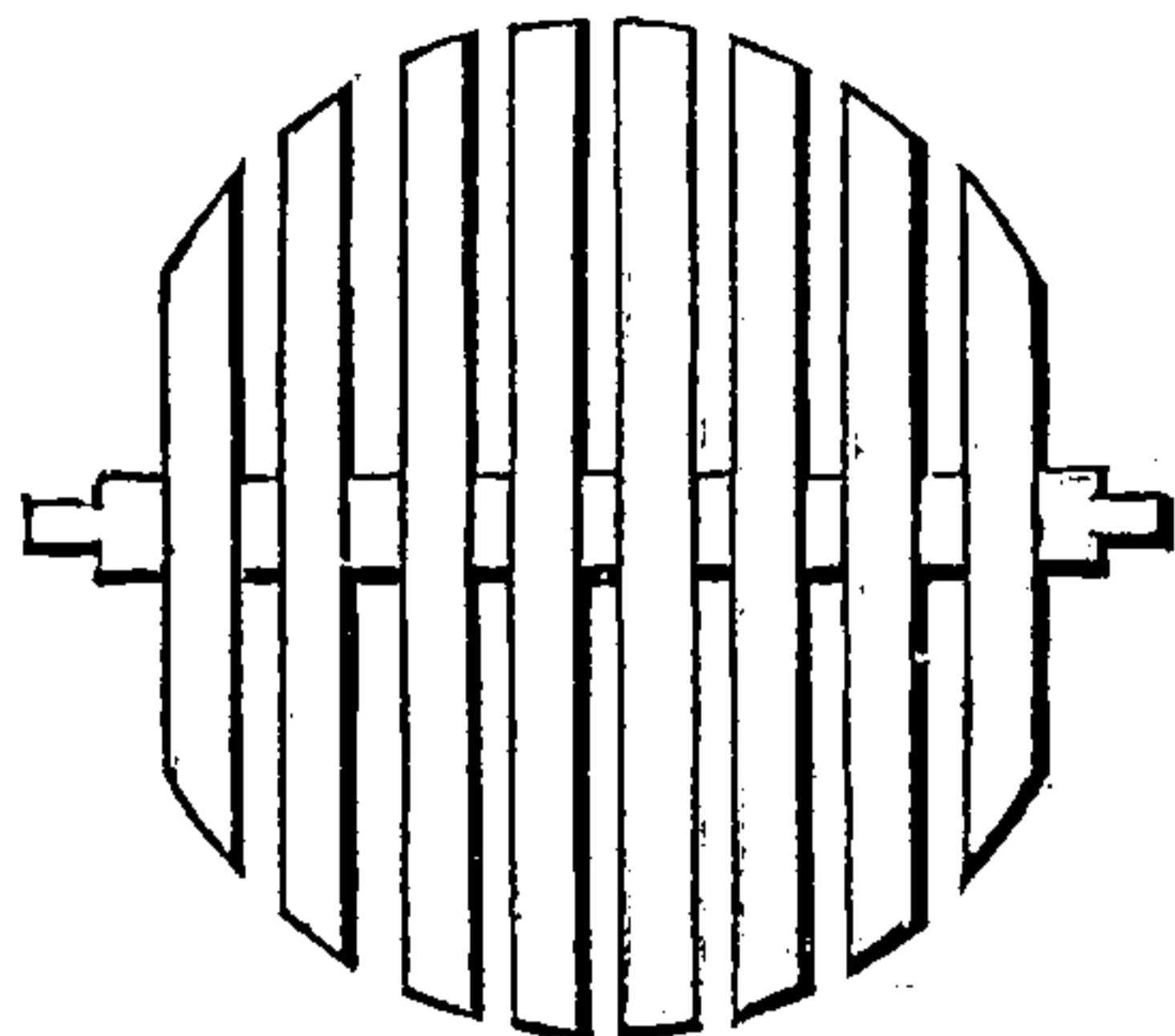

Fig. 7 is a hollow plug, which being made of cast-iron, may be employed advantageously to close the end of the pipes, and connect the heating with the conducting pipes; and instead of the common grate, fig. 3, No. 2, it might be

advantageous to employ one of the form figured as fig. 3, No. 3. When the first bar supports all the cross bars, and there is no ring to the grate, in this case the bars should only extend to within half an inch of the rim of the frame in which they revolve, to allow a draft close to the boiler surface. This form, however, is

Fig. 3. No. 3.



only recommended as an improvement, not having been tried in practice. The following proportions are recommended for the construction of boilers. The furnace in No. 1 may be conical, or nearly so; the others would probably be, if made as represented in Fig. 1, a frustum of a cone, contracting with a curved top to the required diameter of the upper aperture. Numbers 1 and 2 have only been tried, but the experience of those would recommend

the adoption of the following forms in further experiments.

No.	Upper diam. of furnace.	Lower diam. of do.	Height perpendicular.	Thickness of Boiler in water.	Diam. of com. pipes union joints.	Chimney diam.
No. 1.	6 in.	9 in.	18 in.	$1\frac{1}{4}$ in.	$1\frac{1}{4}$ in.	3 in.
2.	do.	10	20	$1\frac{1}{2}$	$1\frac{1}{2}$	$3\frac{1}{2}$
3.	do.	12	22	$1\frac{3}{4}$	$1\frac{3}{4}$	$3\frac{3}{4}$
4.	do.	14	24	2	2	4

The proportions for No. 4 are given on the same principle as the preceding ones; but in all probability, where a power is required greater than that afforded by No. 3, it would be best to employ two boilers of the size of No. 2. The consumption of fuel would be less, and the fire more manageable, besides other indirect advantages; and it may be well to mention, that the proportions of one grate, boiler surface, and chimney in three boilers, coincide very nearly with the proportions laid down by Mr. Tredgold. The only deviation is that which the peculiarity of their form renders necessary.

No. 1 is probably the smallest size generally serviceable; but a boiler rather less, whose lower diameter of furnace is eight inches, and communication pipe 1 inch in diameter, attached to 36 feet of 2-inch pipe, in a well-glazed pit, and a reservoir of 24 gallons, raises the temperature under 130 feet of glass, 19° Fahrenheit; and maintains that temperature twelve hours with a loss of only 4° . It takes about three and a half hours of fire to get it up to its full work: but it begins to heat as soon as the fire is lighted. It requires looking at two or three times in the first three hours, and afterwards without attention will burn nearly all night. The whole quantity here heated is about 30 gallons; and this apparatus would probably suffice amply for 200 or 250 feet of glass.

No. 2 raised 40 gallons 50° per hour, in open vessels, and in the open air; and from a comparison of experiments made with it and the other boiler, it would appear to be nearly double its power. These data may suffice as some sort of guide for those who wish to apply the apparatus; and it will probably be found that No. 3 has nearly double the power of No. 2. By employing coke instead of

cinders, the power is greatly increased; but cinders are the best fuel for these furnaces, and they will not burn coal.

Fig. 2. The circular damper *c c* should be nearly as large as the upper diameter of the furnace, and suspended from the lid about 4 inches below the top. The inverted cone should extend to within about one half of this circular damper, and its opening be rather less than that circle. The small damper in the chimney regulates the draft.

With respect to the reservoir, for stove heat it should contain four or five times as much as the pipes, nay, if not inconvenient, six or more would be better; as here the object is to maintain constant heat, and such a reservoir once heated would hardly grow cold in twenty-four hours, and is heated again very fast, so that three or four hours' fire in twenty-four would be sufficient. For greenhouse work, a smaller reservoir, holding two or three times the contents of the pipes, would be large enough, and of course the smaller the reservoir the shorter time it takes to get the apparatus up to full power. It is, however, found in the case of No. 1, that a reservoir containing nearly six times as much as the pipes is not inconveniently large; and such reservoirs have this advantage, that they obviate all danger of boiling the water to waste.

In conclusion, it may be well to repeat that the iron pipes should be entirely above the boiler (one inch is sufficient height), and that they should incline upwards from the point at which they receive hot water from the boiler, to the point at which they deliver it to the reservoir. One inch in twenty feet is sufficient. This arrangement will generally be found most convenient, but where it is otherwise, and in all cases where the pipes are of considerable length, say above eighty feet, it is advisable to place the air-pipe at the end farthest from the boiler, and give both pipes an equal inclination to the boiler and reservoir.

To those who are turning their attention to this subject, an excellent paper in the Hort. Trans. Lond., by Mr. C. Stodart of Bath, affords much valuable information; though he does not give us the ratio between areas of pipe, and areas of glass, requisite to produce certain temperature; probably because the defects of imperfect glazing would render such ratios practically almost useless: nevertheless a knowledge of them would not be without use, and to those who have leisure and ability for the work, the experiments of Messrs. Dulong and Petit, and other tables published in the Encyclopædia Metropolitana, under the article "Heat," afford ample data.

From a few rough experiments, it would appear that one square foot of pipe to seven of glass for greenhouse temperature, and one square foot of pipe to three and a half of glass for hothouse, are nearly the true proportions.

Since writing the above, we have had an opportunity of consulting Tredgold on Warming and Ventilation, a work in which the subject is treated in a manner at once so scientific and so practical, as to leave little, if any thing, to be desired. It is indeed a master-piece of practical science, and ought not only to be in the hands, but in the heads, of every one who undertakes to apply water to the purposes of heating. We would hardly presume to offer any criticisms upon it, but in one

point he appears to be in error,—an error it is true less important where steam was the medium of heat, and could be laid into and shut off from a portion of the pipes at pleasure; but one which it is important to bear in mind in adopting his calculations, which were made exclusively for steam to hot-water, where such an arrangement is not so easily made.

He assumes that it is necessary to have a heating power of fifty degrees above the outward air for hothouses, and one proportionately great for greenhouses. We believe it will be found that a power of 35 to 40 degrees for the former, and 20 to 25 degrees for the latter, is abundantly sufficient.

It is also to be recollected, that it is impossible by a circulation of hot water to bring the pipes to the temperature produced by steam of $2\frac{1}{2}$ lbs. pressure; therefore an addition of at least $\frac{1}{4}$, perhaps $\frac{1}{3}$, must be made to the quantity of pipe allowed in his calculations.

It would protract this article to a length unsuited to a periodical work, were we to enter more fully into this part of the subject, which indeed requires more data and ability than we possess.

The foregoing hints may serve to prevent any serious mistakes, in making one of Mr. Tredgold's formula.

CULTURE OF THE WHITE AND RED GUAVAS.

(*PSIDIUM PYRIFERUM* AND *POMIFERUM*).

THE White Guava (*P. pyriferum*) grows to a fine little shrub in the West Indies; the flowers emit a very pleasant fragrance, and the fruit is a bright yellow on the outside, but the flesh is light red, melting, and of a pleasant taste.

The Red Guava (*P. pomiferum*,) bears a fine fruit to look at, but is not equal in flavour to the white; both kinds require the same treatment, part of which is detailed in Vol. I., page 119.

1. Put the plants in a rich loamy soil, and let the pots be well drained with potsherds.

2. During the growing season they may stand in a warm part of the greenhouse, give a copious supply of water and occasionally liquid manure at the roots, and syringe a little clear water over the tops; but at the time of the fruit beginning to ripen, the supply must be lessened at the roots, and syringing wholly discontinued.

3. Pot the plants at first in small pots, and shift them into larger as they require it, being careful never to allow the roots to mat; eventually plant them in tubs or larger pots, where they may remain for many years without further removal.

4. As the fruit is generally formed and ready for ripening in the autumn, it is best not to winter the plants until the fruit is ripened off, which is generally about March or April.

5. In the autumn, take the plants successively into a house where the temperature is from 60 to 70 degrees Fahr., and they will ripen a succession of fruit from December until the end of March, and if judiciously managed, of a good flavour.

6. Propagated by cuttings of the half-ripened wood, which may be planted in pots of sand, and covered with a glass; immediately after the ripening of the fruit is the best time, just before the plants are placed in a low temperature to winter.

7. When the cuttings are planted, plunge the pots in a frame where they will receive a brisk heat, and they will soon produce roots. They also propagate easily by layers, cut on the upper side, and slightly twisted to bring the end of the tongue in contact with the soil.

CULTURE OF THE COCOA-NUT TREE.

(COCOS NUCIFERA.)

THIS is a very beautiful Palm; a native of the East Indies, and cultivated in nearly every part of the tropics, being without exception one of the most useful trees in existence. It is seldom found growing to any thing like perfection in our stoves, although it has been long introduced. It grows immensely high and spreads its head over a circumference of 40 or 50 feet. The mode of culture is as follows:—

1. Pot the plants in a light sandy loam; lay about one third of potsherds at the bottom of each pot, which will insure a good drainage, for although the plant requires a very moist atmosphere, it will not bear the least stagnation of water at the roots.

2. Place the plant, when potted, in a situation where it will receive a very moist but powerful heat, never less than 70 degrees during the season of growth; but from the beginning of November till the end of February, which is the best season for wintering, because there are the fewest natural excitements, it will do with 55 degrees and a dry air.

3. Never allow it to stand in a situation where it is exposed to the direct rays of the sun, for from this very cause may be attributed nearly all the ill success attending its culture; always break the force of the sun's rays by placing other plants before it, as in the tropics it is always grown in sheltered situations.

4. The usual mode of propagation is by seeds:—Cut off one end of the hard shell of the nut, to allow the plant to protrude its roots; insert the nut in as small a pot as it will allow, filled with the same soil as recommended for the old plant; plunge the pot up to the rim in a good bark bed, and there let it remain with little or no water until it has begun to grow; then put it into a larger sized pot, take it from the bark bed, keep it gently supplied with water, and treat it in every respect as an old plant.



THIS PAGE IS LOCKED TO FREE MEMBERS

Purchase full membership to immediately unlock this page

DELVE INTO FANTASY, MAGIC, MYTHOLOGY & FOLKLORE

Forgotten Books'
Full Membership gives
access to 797,885 ancient
and modern, fiction and
non-fiction books.

Continue

*Fair usage policy applies

THE COMPOUND FLOWER TRIBE (COMPOSITÆ).

MADIA ELEGANS. Elegant Madia. This is a striking hardy annual; the flowers are yellow, with a blood coloured spot at the base of some of the petals: it is desirable for the flower border, where it flowers through most of the summer months. *Bot. Mag.*, 3548.

CLASS II.—PLANTS WITH ONE COTYLEDON (MONOCOTYLEDONEÆ).

THE LILY TRIBE (LILIACEÆ).

LILIUM PEREGRINUM. Narrow-sepaled White Lily. This species grows very strong, and produces from eight to ten bold white flowers, each three inches long, on a terminal spike. The bulb was imported from the Cape of Good Hope, to which country it had been most likely introduced from Holland by some of the Dutch colonists. It flowers in July. *Brit. Fl. Gard.*, 367.

ORCHIS TRIBE (ORCHIDÆ).

ONCIDIUM CRISPUM. Curled-flowered Oncidium. We noticed this handsome species in the Number for August, from a fine figure in the Botanical Magazine for June, 3499. Suffice it to say that the representation in the Botanical Register for January consists of eight beautiful large deep chestnut-coloured flowers on a single scape, produced in the hot-house of Richard Harrison, Esq., Liverpool. There appears to be no bounds to this very interesting and justly-admired family of plants. Dr. Lindley notices in the Number before us (January) twelve distinct and handsome species of the genus *Oncidium*, most of which are at present, but we hope will not be long, unknown to our collections. We anticipate ere long seeing species now conspicuous for their beauty in our hothouses, or only known to the botanist from specimens in his herbarium, brought to the highest state of perfection in a degree of heat very little above that required for New Holland plants. Should this be realised—and there is good reason to hope it will—our plant-houses generally will become a source of delight and amusement, to say the least, nearly double to what they are at present.

ORCHIS TRIBE (ORCHIDÆ).

TRIGONIDIUM OBTUSUM. Blunt-petaled Trigonidium. A most singular species with a very odd appearance, the petals are of a dirty blotched yellow, somewhat obtuse, and considerably reflexed; it is said to be of easy cultivation, and to flower freely. It was introduced through the exertions of Mr. Colly, in Demerara. *Bot. Reg.* 1923.

BURLINGTONIA CANDIDA. Snow-white Burlingtonia. The vegetable kingdom comprehends nothing more perfectly lovely than the delicate flowers of this plant, in which not a tinge of colour sullies the snow-white transparency of the petals, unless it be a faint dash of straw colour on the lip. For its introduction to this country we are indebted to Mr. Bateman, who imported it from Demerara, and flowered it in his rich collection at Knipersly, in April 1835. The aspect of the plant is that of *Notylia punctata* with its pendulous scape, but the flowers seem to have no parallel among the whole extensive natural order of Orchidæ, but, as Dr. Lindley observes, its lower sepals being united into one, its lip

having a short horn at its base, in the column being taper, and in the structure of the pollen masses, it agrees with *Rodriguezia*, but its membranous and convolute (not herbaceous, or coloured and spreading) flowers, its unguiculate (not sessile) petals and sepals, its long slender (not dwarf) column, and its membranous-lobed lip, so much longer than the other parts, have satisfied me that it is a truly distinct genus. *Bot. Reg.* 1927.

THE LILY TRIBE (LILIACEÆ).

TRITELERIA UNIFLORA. One-flowered Tritelia. A pretty bulbous plant, with flowers of a delicate sky-blue tinge; but, unfortunately, the plant smells powerfully of garlic. It cultivates easily in a frame, or even in an open border, kept dry in winter. *Bot. Reg.*, 1921.

THE CORN-FLAG TRIBE (IRIDACEÆ).

SISYRINCHIUM SPECIOSUM. Showy Sisyrinchium. A pretty little plant imported by Mr. Towart, gardener to Her Royal Highness the Duchess of Gloucester, Bagshot Park, and by him communicated to Mr. Murray, of the Glasgow Botanical Garden. About Valparaiso it is found on sandy hills; and a dry and light soil, with a sunny situation in the greenhouse, are what are required to bring it to perfection in our country. The flowers, which are of a beautiful blue, with a portion of yellow at the base of each sepal, are produced about June. *Bot. Mag.*, 3544.

THE SPIDER-WORT TRIBE (COMMELINACEÆ).

TRADESCANTIA CARICIFOLIA. Sedge-leaved Spider-wort. Allied to the common garden Spider-wort (*T. Virginica*), differing however in its much smaller size, slender habit, much narrower leaves and bracteas, and in the entire freedom from hairs of every part of the surface of the plant, the margins of the sheath alone being ciliated. It is a native of Texas, where it was found by Mr. Drummond, and will flower in August and September under a cool frame. *Bot. Mag.*, 3546.

NOTICES OF NEW AND RARE PLANTS

IN FLOWER IN THE LEADING NURSERIES AND PRIVATE GARDENS IN THE
VICINITY OF LONDON.

—————

MESSRS. HENDERSON'S, Pine-Apple Place. *Camellia Hendersonii*. This species was raised from seed by Messrs. Henderson, and was accordingly named in honour of them; it is extremely beautiful, the colour of the flowers being a superb crimson; it is now flowering in their nursery, and well established plants may be had of them for five guineas each; we can only say that it justly merits a *prominent* situation in every collection where this highly ornamental genus is cultivated. *Cineraria Hendersonii*. This is another of Messrs. Henderson's seedlings, and is decidedly the most beautiful species of this genus we have ever seen; it is now beginning to throw up its pretty reddish-purple coloured blossoms, and will con-

tinne flowering in great abundance during the whole of the summer. *Epacris impressa*. Several remarkably fine specimens of this much-admired species are now most beautifully covered with their delicate crimson-coloured flowers; and these, with various other species of this truly interesting genus which are now in flower, have a very imposing appearance, and are cultivated by Messrs. Henderson with the most complete success. It is almost needless to add, that the various species of this beautiful genus (*Epacris*) contribute more (both by the elegance and simplicity of their flowers and foliage) towards ornamenting our greenhouses and conservatories, at this season of the year, than any others with which we are acquainted, if we except the genus *Camellia*. *Oxalis versicolor*. This charming little plant is now beautifully in flower at the above nursery, and forms a peculiarly interesting feature among our early-flowering greenhouse plants. Messrs. Henderson have also a most splendid collection of *Hyacinths*, *Narcissuses*, &c., now in flower.

MR. KNIGHT'S, Chelsea. *Charlwoodia australis*, a very pretty stove-plant, is now beautifully in flower. *Scottia lævis*, a new species of this small, but interesting genus, which Mr. Knight has imported from New Holland, is also in flower, as well as several new species of *Amaryllis*, which are strikingly beautiful. *Azalea Indica variegata*, a most splendid variety of this much-admired species, with striped flowers, may now be obtained of Mr. Knight, at three guineas a plant; and no collection, however small, should be without it.

MESSRS. LODDIGES', Hackney. *Bifrenaria fragellifera*. This beautiful plant, which forms a conspicuous feature in the natural order *Orchideæ*, is now exhibiting its splendid flowers in the rich collection of orchideous plants at the above named nursery. Though most collections contain plants of it, yet, we believe, it has never flowered in this country above twice or thrice before, and, therefore, a short description of it may not be unacceptable to our readers: the flowers arise from the base of the stem, on a short footstalk about three inches in length; they are sometimes solitary, sometimes in pairs; and the number is probably increased according to the size and strength of the plant; they approximate in shape to many of the species of *Maxillaria*, but are considerably larger; they are of a cream-coloured ground, with spots of a dark chocolate colour. The habit of the plant being to attach itself to pieces of wood, it is consequently suspended from the roof of the house, and its long slender stems, contrasted with the extraordinary size and peculiar beauty of its flowers, have a very interesting and imposing appearance. Some botanists (and perhaps with propriety) assign this plant to the genus *Maxillaria*, but we have adopted the generic name *Bifrenaria*, because that was the one given to it by Dr. Lindley when it first flowered in the collection of Messrs. Loddiges. Among their splendid collection of *Camellias*, they have many beautiful species now in flower, and some remarkably fine specimens are producing their splendid blossoms in great abundance; we noticed particularly a handsome plant of *C. reticulata* coming into flower, which is generally considered to have the precedence, in point of beauty, over all other known species of this genus.

MR. LOW'S, Clapton. *Oncidium cebolleti*. A very fine specimen of this

interesting plant is now in flower. Mr. Low has recently imported a great variety of valuable seeds from New Holland, among which he expects to find some excellent species of *Pultenæa*, *Hakea*, *Dillwynnia*, &c.; and it is more than probable that there will be some new and interesting species produced from them.

MESSRS. ROLLISON'S, Tooting. *Oncidium luridum*. Several very fine specimens of this well known and much admired species are now in flower in the above mentioned nursery, and as some of the flower stems are from five to six feet long, and are beautifully studded with their pretty delicate-looking blossoms, they have a most elegant and fascinating appearance. *Oncidium ampliatum* is also beautifully in flower, and a very fine variety of *Catasetum luridum*; the flowers of which are much larger than those of the original species, and are prettily marked round the edge of the lower lip with dark brown stripes.

MR. YOUNG'S, Epsom. *Genista monosperma*. This interesting plant, which, for the delightful fragrance of its pretty little white blossoms stands almost unrivalled, is now beautifully in flower in this nursery; and, although its regular season of flowering may be said to be in the months of May and June, yet it has here produced an abundance of flowers during the whole of the past winter; this renders it still more valuable, and to every collection of greenhouse plants it would prove a most desirable acquisition. Mr. Young has also two other similar (though apparently quite distinct) species of *Genista*, which he supposes are new, but which have not yet flowered. *Passiflora Loudoniana*. A new and highly beautiful species of *Passiflora* has, for some time past, produced its brilliant crimson-coloured blossoms in great perfection, and there still remain a few flowers upon it; it is by some considered as identical with *P. Kermesina*, but upon comparing them it will at once be allowed that they are quite distinct, as this plant grows far more luxuriantly; the foliage is of a deeper green, and the flowers are decidedly superior in the richness of their colours to those of *P. Kermesina*; and we know of no species that is more worthy of a situation in the stove, as a climbing plant, than the one here spoken of. *Lasthenia glabrata*. This is a new and very pretty greenhouse annual, and, like many other plants, belonging to the natural order *Compositæ*; the flowers are of a yellow colour. It is now flowering very freely at Mr. Young's; and, as it is very probable that it may prove hardy, it is by no means unworthy of notice.

NOTICES ON THE CULTURE OF NEW AND RARE PLANTS

IN THE PRINCIPAL NURSERIES AND PRIVATE GARDENS IN THE
VICINITY OF LONDON.

On the Cultivation of Orchideæ, as practised by Messrs. Rollison, Tooting.

MANY and varied are the systems pursued by different descriptions of persons, in the cultivation of this singularly beautiful tribe; and certainly no family of plants presents a more pleasing variety of interesting objects to the eye of the botanist, or

is more worthy of the attention of the lovers of floriculture, than the one now before us; and as we cannot but perceive the growing attachment for, and increasing cultivation of, this beautiful tribe, we are induced to lay before our readers a brief outline of the system pursued by Messrs. Rollison, and we are sure that his collection only needs to be seen to prove the complete success with which it is attended.

Some persons whose characters stand high in the list of the cultivators of Orchideæ, contend that excessive heat, accompanied with a great degree of moisture, is essential to the well-being of these plants; while others, of equal eminence, affirm that a low temperature, with very little (if any) atmospheric moisture, is best adapted for growing them to perfection. It is not our object here to endeavour to show the merits or demerits of either of these systems, but merely to state that Messrs. Rollison grow their orchideous plants in a mean temperature, varying between 65° and 75° Fahrenheit, with a moderate degree of moisture; and, by thus avoiding each of the before-named extremes, cultivate them to a degree of perfection to which very few attain.

Their house is constructed with a span roof, and runs in a line from north-east to south-west; down the centre of the house there is a brick pit, which is filled at the bottom with brick-rubbish, and towards the surface with *old* bark, (that is, such as has been previously used, and from which all the heat has been extracted,) or coal ashes, and on this the largest plants are elevated to within three or four feet of the glass; all round this pit there is a path, which is paved with stone; and which (that is, having a path all round the inside of the house) is a very desirable object in a house of this description, as the plants are so arranged as to be seen to advantage from all parts of the house; between this path and the outside wall there is a stage, on which are placed all the young and small plants, among which are here and there introduced a few large ones to give a more pleasing effect.

Having thus briefly detailed a few particulars relative to the construction of Messrs. Rollison's Orchideæ house, we will now proceed to notice the manner in which it is heated, which is according to the hot-water system; this has been adopted in preference to heating either by steam or smoke-flues, because the house may be heated with hot water a considerable deal sooner than by either of the above-named methods, and also, because it retains the heat much longer; added to this the steam which evaporates from the boiler is sufficient to keep the house continually in a humid state, except in hot weather, when no fire is required, then other measures are resorted to, such as throwing down water in the paths, and occasionally sprinkling the plants over with water from a syringe; also, during the summer season a shading of thin canvass is thrown over the roof of the house in the heat of the day to keep off the powerful rays of the sun, as it is a well known fact that direct solar light is prejudicial to the free and proper growth of these plants. It now remains to show Messrs. Rollison's system of potting, and the materials used by them in that process; and, as this is an important feature in the cultivation of Orchideæ, we shall here be a little more explicit. The first operation to be performed, is to take a pot somewhat smaller than the one in which the plant is to be placed, and turn it upside down in the bottom of the said pot; this not

only tends to fill up the pot, but also assists the drainage very much, which is a very important object, as these plants will not thrive at all, if the soil is allowed to become saturated with water, but on the contrary require a particularly free drainage; this done, a quantity of peat is procured, and also a quantity of broken potsherds; some large pieces of this last are then put into the bottom of the pot, round the one which has been placed in the inside, then a good portion of smaller potsherds are put in on the top of these, and a layer of peat is then introduced, above which is placed another layer of potsherds, then another layer of peat, and so on till the pot is filled; these materials are in some instances raised somewhat above the level of the top of the pot, and on them the plant is placed, the roots of which are then covered with equal parts of the same materials, and when the roots of the plant reach the edges of the pot, it is removed into one a size or two larger, according as may be required. This system of potting answers remarkably well with most of the species of *Oncidium*, *Zygopetalum*, *Dendrobium*, &c., but many other species, viz. some of the last-named genus *Dendrobium*, some species of *Sarcanthus*, but more especially *Broughtonia sanguinea*, and *Renanthera coccinea*, are placed on pieces of wood, which are suspended from the roof of the house; the roots of these in process of time adhere to the wood and grow very luxuriantly; this last system bears a striking assimilation to the natural habits of these plants, as they are for the most part found growing on the stems and branches of trees, from which they derive no nourishment, but subsist wholly on the surrounding atmosphere. Another system practised by Messrs. Rollison, is that of suspending plants (in wire baskets made for the purpose, or small rustic wooden ones of various shapes) from the roof of the house; these baskets are filled with *sphagnum*, in which are planted several species of *Stanhopea*, *Vanda*, &c., to which this mode of treatment seems peculiarly adapted. In conclusion, we would just add that Messrs. Rollison allow no water to newly-imported species, till after they have started growing, as watering in this state frequently tends to make them damp off.

Our readers will by this time have perceived that the main features in Messrs. Rollison's system of cultivation are, moderate heat, with a slight degree of moisture; heating with hot-water, and potting for the most part in a mixture of potsherds and peat. We are aware that much more might be said on this interesting subject relative to the propriety of giving these plants a season of rest, bottom heat, and various other particulars relative to the manner in which they are generally cultivated, but as we wish to confine ourselves to our original object here (viz. that of giving an outline of Messrs. Rollison's system of cultivation), we would only just add, that for a proof of the success with which it is attended we refer our readers to the plants themselves, where they will find a more demonstrative proof than any language of ours can express.

Grevillea rosmarinifolia. This interesting plant, which has been known in this country for more than twelve years, and to which has always been assigned a situation in the green-house, has at length been proved by Mr. Young, of Epsom, to be completely hardy; he has for the last four years grown it in an open border,

and in a very exposed situation, without any protection from either frost or wind, and the result is, that the plant has grown very luxuriantly, and is now in a remarkably healthy state; during the very severe weather of the past season, the tops of the young shoots have been somewhat injured, but this may be accounted for by the situation in which it is placed being so very much exposed; and we think that there cannot be the least doubt, but that, if planted in a sheltered situation, this plant would prove a valuable accession to the present stock of hardy evergreens in our arboretums and pleasure grounds; and certainly it needs no other recommendation than that of being a *hardy evergreen*, to render it at once a desirable acquisition to any collection of hardy ornamental shrubs.

OPERATIONS FOR MARCH.

AURICULAS will now begin to show their flower buds. Let them have plenty of air during the day, but shut them closely down at night, and top-dress.

CARNATIONS. About the end of the month, plant the last year's layers into large pots to bloom.

DAHLIA ROOTS should now be potted, or plunged in a little old tan in the stove or frame, to forward them for planting out, &c.

FORCING. Continue to take into the stove, Roses, Pinks, Carnations, &c., for the final bloom, previous to the succession in the open air.

HARDY ANNUALS. If the weather be fine, commence sowing for the general blow at the end of the month; but if the weather is cold or wet, defer it until April, or the early part of May.

MIGNONETTE AND TEN WEEKS' STOCK. Those sown last month must have as much exposure to the air as the weather will allow, and superfluous plants thinned out of the former to about twelve in a pot, and the latter about six.

PELARGONIUMS. Cuttings should now be put in, and old plants cut down.

POLYANTHUS SEED, if not sown last month, should be done as early in this as possible, and the old plants top-dressed.

RANUNCULUSES should be planted early in the month.

TENDER ANNUALS. Commence sowing in pots, and place them in a frame on a slight hot bed, or on the fires of the vinery.

TULIPS will now be up; examine them to see if any are cankered.

TIGRIDIA PAVONIA. Sow the seed at the end of the month, in pots or boxes. Also the old bulbs may be planted in warm situations at the end of the month, if the weather is fine.



THIS PAGE IS LOCKED TO FREE MEMBERS
Purchase full membership to immediately unlock this page



Never be without a book!

Forgotten Books Full Membership gives universal access to 797,885 books from our apps and website, across all your devices: tablet, phone, e-reader, laptop and desktop computer

A library in your pocket for \$8.99/month

Continue

*Fair usage policy applies



Penambora acuminata

Hort. bot. - Smith. 1827.

APRIL 1827

RENANTHERA COCCINEA.

(CHINESE SCARLET-FLOWERED AIR PLANT.)

CLASS.
GYNANDRIA.ORDER.
MONANDRIA.NATURAL ORDER.
ORCHIDEÆ.

GENERIC CHARACTER.—*Sepals* three, spreading, linear. *Petals* somewhat obtuse, rather larger than the sepals, and undulated. *Lip* slightly saccate at the base. *Pollen masses* two.

SPECIFIC CHARACTER.—*Epiphyte*. *Stem* leafy, round, twelve feet long, sometimes branched, sending forth many long, fleshy, tortuous roots, which fasten or cling so firmly to the wall, or other body within reach, as to render it a matter of difficulty to liberate them without injury. *Leaves* flat, fleshy, without veins, disposed in two opposite uniform rows, of a dark shining green colour, each more or less notched at the end, and about five inches long by one and a half broad. *Flowers* numerous, produced on a lateral loose panicle, the stalk and branches of which are hard and round. *Bractees* small, and apparently withered. *Ovarium* situated at the end of the flower-stalk, of a faint red, characterised by six furrows. *Sepals* spreading, erect, fleshy, of a pale scarlet, obscurely and irregularly blotched with a deeper colour. *Petals* marked with yellow bands of a beautiful scarlet ground, and abruptly waved in the middle. *Labellum* very dwarf, joined with the column, three-lobed; the back lobes yellow and marked with scarlet, the front one reflexed, scarlet, with a portion of yellow at the base. *Column* half round, as long as the labellum, scarlet, marked with yellow. *Stigma* hollowed out, nearly round. *Anthers* terminal, deep scarlet, blunt, one-celled. *Pollen masses* two, two-lobed behind.

THE merits of this magnificent plant were for a long time only known from the statements of a few individuals who travelled in China, together with a figure in the possession of the London Horticultural Society, and some remarks in the work of Loureiro, a Missionary, published in 1790; until a few years ago a plant flowered in the gardens at Claremont, from which a beautiful drawing was made for, and inserted in, the Botanical Register. The species had been at different times imported from China, and recognised amongst orchideous plants for its long leafy stems and fleshy veinless leaves; and from the peculiarity natural to all epiphytes, of attaching itself to damp or dry walls, pieces of wood, or any other body within reach of its long fleshy tortuous roots. A long time elapsed, after it had become general in collections, before a correct notion could be formed of the beauty of the flowers or the precise nature of the inflorescence. The reports of all travellers who had seen the flowers allowed them to surpass almost every other vegetable product known.

Dr. Lindley observes, in the Botanical Register, when speaking of this plant, that “The cause of previous want of success in inducing it to flower, has resided in its having been cultivated in too dry an atmosphere. Mr. Fairbairn, gardener to His Royal Highness Prince Leopold, at Claremont, impressed with this opinion, tried the effect of tying moss around the stems, and keeping it constantly damp, exposed as much as possible to the influence of the sun; with what success his experiment has been rewarded, appears from the accompanying representation of a portion of a panicle, two and a half feet long, which was finally produced in the hothouse at Claremont, in October, 1827.” See Bot. Reg.; Vol. 14, t. 1131. Now it appears to us, that a mistake has arisen as to the real cause of its flowering. In this we are well supported by the fact of the plant having rarely—we might almost say never—produced flowers in those collections where great moisture is kept up during the whole of the season. At Wentworth, under the superior treatment of Mr. Cooper, the species has flowered several successive years; and it is well known, that that intelligent cultivator never washes his plants over head, nor keeps up amongst them a heavy moist heat. The plan we adopted with the plant that flowered at Chatsworth, and of which our present figure represents a portion, was as follows:—About April, 1836, we had a plant put into a small house appropriated to the growth of a few stove plants, in which the heat varied from sixty-five to seventy degrees; it was kept free from moisture, except what rose from watering and occasional syringing.

Here the whole of the plant was exposed to the direct rays of the sun, and, as might be expected, this treatment caused the leaves slightly to shrivel, as well as turn a little yellow, but, by occasionally washing them over in the afternoon with the syringe, the plant did not suffer much; after it had been in this exposed situation for three months, we had the satisfaction of seeing two fine spikes of flowers pushing forth, one of which came to maturity. We have little doubt, if proper attention is paid to placing the plant well up to the glass, and without the use of shade, that a flower bud will soon make its appearance on a well established plant; it is necessary here to observe, that the plant ought to be six or eight feet high before this experiment is attempted. It is no wonder that the Chinese take pride in suspending from the ceiling of their rooms many of this interesting tribe, in coarsely wrought wooden baskets, some for the sake of their magnificent flowers, and others for their delightful fragrance. The plant at Chatsworth, when in flower, was truly splendid, but scarcely fragrant, and being placed in the cool end of the Orchideæ house it continued beautiful for nearly four months; and there is no reason to doubt, if the plant had been placed in a light situation, in a much

cooler house, or even in the drawing room, but that the flowers would have continued perfect nearly as long. It will succeed well in peat mixed with reduced potsherds, if placed carefully about the roots so as to ensure a safe drainage, or in *sphagnum* or *hypnum* moss cut short and packed closely about the roots. Young growing plants will not succeed better in any place than where a strong heat and an abundance of moisture is kept up; any of the young branches taken off and potted in moss, will soon make young plants.

The accompanying wood-cut is a diminished representation of the plant, showing the mode of growth, and situation of the flower spike. In the woods in Cochin China, it is found growing on trees.

The generic name *Renanthera*, says Mr. Loudon, is contrived by Loureiro, to express the kidney-form or reniform shape of the pollen masses.

The specific name, *coccinea*, signifies scarlet, or carmine, slightly tinged with yellow.





W. Miller del. - Smith sculp.

Pancratium calathinum

APRIL 1837



THIS PAGE IS LOCKED TO FREE MEMBERS

Purchase full membership to immediately unlock this page

DELVE INTO FANTASY, MAGIC, MYTHOLOGY & FOLKLORE

Forgotten Books'
Full Membership gives
access to 797,885 ancient
and modern, fiction and
non-fiction books.

Continue

*Fair usage policy applies

PANCRATIUM CALATHINUM.

(CUP-FLOWERED SEA DAFFODIL).

CLASS.
HEXANDRIA.

ORDER.
MONOGYNIA.

NATURAL ORDER.
AMARYLLIDEÆ.

GENERIC CHARACTER.—*Corolla* infundibuliform; tube long, with a six-parted limb. *Cup* consisting of twelve membranous clefts, on the edges of which the stamens are seated.

SPECIFIC CHARACTER.—*Plant* a bulbous-rooted stove perennial, from two to two-and-a-half feet high. *Leaves* shorter than the scape, in number about six, fusular, and clasping or sheathing the stem at the base, each from one to two inches broad, lanceolate, flat, and pointed. *Scape* nearly two feet high, spathe lanceolate, either one or many flowered. *Flowers* sessile, funnel-shaped, of a clear white, and delightfully fragrant; tube blunt, three inches or more in length, of a green colour, a little larger than the limb, which is wholly white, and bent back at the top, entirely parted from the crown; segments lanceolate, narrow. *Crown* white, a trifle shorter than the limb, divided into six lobes, on the divisions of which the stamens are seated. *Stamens* equal in number to the lobes of the crown. *Filaments* white. *Anthers* deep yellow when the pollen is ripe.

THIS showy species of *Pancratium* is a native of the Brazils, and has been some time known in this country, although we meet with it but seldom in collections. It is highly deserving of cultivation, on account of its large handsome flowers and the delightful fragrance which succeeds their opening, and the amazing length of time each continues perfect.

Mr. Campbell, of the Manchester Botanic Garden, furnished the sample for the drawing some time last summer. And we were informed that the length of time the flowers continued perfect was almost incredible. For culture, propagation, &c., we refer the reader to page 268 of the third volume.

Pancratium is a name given by the Greeks to a kind of *Scilla*; but the word, signifying allforce, is clearly illustrative of its powerful effects in medicine.



Holden Del. Smith sc.

Tropaeolum brachyceras

APRIL 1837

TROPÆOLUM BRACHYCERAS.

(SHORT-SPURRED TROPÆOLUM).

CLASS.
OCTANDRIA.ORDER.
MONOGYNIA.NATURAL ORDER.
TROPÆOLEÆ.

GENERIC CHARACTER.—See Vol. II., page 123.

SPECIFIC CHARACTER.—*Root* perennial. *Stem* climbing, very slender, of a pale green colour. *Leaves* alternate, six, and sometimes seven-lobed; lobes oblong, rather blunt, pale green and very delicate. *Leafstalk* nearly an inch long, slender, and twining like the branches. *Flower-stalk* a trifle longer than the leafstalk. *Calyx* consisting of five slightly obtuse pale green segments. *Petals* five, bright yellow, except the back one, which strikes into two lobes, each of which is prettily pencilled with a rich dark brown at the base. *Stamens* eight, a little longer than the style. *Germen* separating into three lobes.

A SMALL box, containing bulbs and roots of different descriptions, was received at Chatsworth last spring, from His Grace the Duke of Devonshire, to whom it was most obligingly presented by Miss A. G. Reinagle, who had previously received it from her niece; the roots having been most likely collected in Valparaiso.

On examining the contents, to our great pleasure we found several roots to belong to the genus *Tropæolum*; and as Miss A. G. R.'s niece's account of them led us to expect that some would prove new, and being already aware of there being several handsome species in existence besides those known in our gardens, we watched the progress of the new arrivals with much pleasure and anxiety, when, about June, we had the gratification to witness the production of the elegant little yellow flowers represented in the figure. This is the only one that has flowered.

This species, in growth and habit, is so much like *T. tricolorum*, that we were unable to detect any material difference until the flowers appeared, although a root of each was grown in the same pot. The flowers of each plant began to expand about the same time, and their delicate branches having been intermixed over the

trellis, the most elegant and interesting picture was produced by the contrast in the colour of their flowers.

For culture and propagation, we refer to page 123 of the second Volume, and page 153 of the third Volume, where *T. tricolorum*, &c., are treated of.

The generic name will be found explained at page 23 of the second Volume.

Dr. Lindley observes, in the Botanical Register, page 1926, “ That this species was some years since introduced by Mr. Cruickshanks, but was afterwards lost or not brought into notice.”



THIS PAGE IS LOCKED TO FREE MEMBERS
Purchase full membership to immediately unlock this page



Never be without a book!

Forgotten Books Full Membership gives universal access to 797,885 books from our apps and website, across all your devices: tablet, phone, e-reader, laptop and desktop computer

A library in your pocket for \$8.99/month

Continue

*Fair usage policy applies

those of wood, and utterly useless as fuel, but exceedingly valuable in heavy, or inert, peaty soils destitute of lime.

We do not pretend, in this place, to enter, chemically, upon the constituents of coals; it will suffice to say, that where white ashes prevail, and if these effervesce and dissolve when tested with a dilute muriatic acid, chalk is present. In cases where the coals leave a reddish or brown ash, much iron and siliceous earth are present. Such ash is produced by the coals about Bath, Radstock, and other districts of the west of England. These red ashes are inert, but become useful to heavy and peaty soils; they are worthless as fuel.

Wood, where it abounds, and can be obtained at little expense, yields, if large logs be burnt, a very intense heat, and for day-fires may be employed with the black ashes of sea-coals very economically; and the results of the combustion are an admirable manure in stiff loams, for strawberries, raspberries, asparagus beds, &c.; but wood alone is fugacious, and used with sea-coal drives the fire on at a gallop, furnishing in fact a sort of oxy-hydrogen blowpipe, which produces the more rapid and wasteful expenditure of both materials.

These hasty observations we have put together, as leaders to future remarks which may apply more fully to the minutiae of the subject; at present, we leave it, observing merely that sea-coal ought to be used alone, or with its ashes and small cinders; that *wood* ought always to be tempered by sea-coal, sifted ashes where these can be obtained, or with the moistened slack or dust of inland pit-coal, which never solders, and can scarcely be made to burn alone; and that *all ashes* which contain alkaline, or chalky salts, are excellent manures, and ought, to the slightest particles, to be preserved for the use of the garden or the farm. They form the very best meliorator of heavy loams, and their extensive use tends much to economise the outlay of the forcing departments.

CULTURE OF THE JOLLIFIA AFRICANA.

THIS fine climbing stove plant is a native of Zanzibar, where it will climb thirty or forty feet; it is also called *Telfairia pedata*, and *Feuillea pedata*. The best soil in which to grow it, is light sandy loam, without any mixture of dung, or it would grow too rampant and strong, and would scarcely ever flower.

As the plant grows and spreads, cut the branches well in for several times, until the laterals begin to show flower, and by the end of July or beginning of August the flowers will be expanded.

Cuttings of the laterals or from the extreme ends of the branches, when struck, will come into flower whilst the plants are quite small.

When the cuttings are separated, plant them in a pot of light soil, cover them with a glass, and plunge the pot in a cucumber frame, where they will receive a good heat, and they will root in little more than a week.

When rooted, pot them off into small pots, replace them in the frame until they have begun to grow, afterward remove them to the stove and treat them as old plants, and they will usually flower in a month after being potted off.

DESIGN FOR A NEW FLOWER STAND.

THE accompanying design for a Cast-iron Flower-garden stand was communicated by our respected correspondent, Mr. Saul, of Lancaster, of whom the moulds may be had at a little cost. The figure represents a Swiss guard, in the fancy costume peculiar to the reign of Francis the First, in the sixteenth century. The dress consists of a jacket and short-kneed culottes (breeches), made of fine scarlet cloth, with sleeves, like those worn by the renowned Amadis of Gaul; having narrow slashes, like stripes, filled in by very dark purple or black velvet. The culottes tie above the knee with large bows of rich tabby scarlet riband; over this jacket is worn a coat of mail armour, of polished steel, which, notwithstanding its massy appearance, is very light, and fitted for general wear; the breast-plate and corslet are beautifully wrought, as are the ornaments on the shoulders. The covering for the legs consists of a kind of stocking pantaloon made of deer skin; on the feet are fastened scarlet sandals of morocco leather; these merely cover the toes, where they are notched in accordance with the fashion of those days, and are kept firm on the foot by the leathern strap passing over the instep. The cap is made of scarlet cloth, with a battlement edge; and, considered with the whole, has a suitable and striking effect.

In each hand, the figure is represented as bearing a bason, or receptacle for a flower pot; and, if thought well, these will answer the purpose of a stand for cut flowers; also, on the head, is represented another bason adapted to the same purposes. The whole is made of cast-iron, and may be painted any colour that the taste of the possessor may dictate. A grass green would look well, and pleasingly accord with the green foliage; or it would have a novel, yet singular appearance, if painted agreeable to the colour of the dress. We would refer the reader to pages 23 and 89 of the Second Volume, for figures and descriptions of two other flower-stands designed by Mr. Saul.



CULTURE OF THE AKEE TREE.

(BLIGHIA SAPIDA.)

MANY of the tropical fruit-trees are very ornamental, and some of them may, no doubt, be grown to a degree of perfection that would render them valuable as an addition to our dessert; of this last kind, perhaps, we might class the *Akee Tree*, (*Blighia sapida*). It is a native of the West Indies, where it grows to twenty



feet and upwards. It has been long an inhabitant of this country, and is yet very little known, and found in very few collections. I have never seen the fruit, but am told that it possesses a slight acid, and when well ripened is not much inferior to a Nectarine: it grows to the size of a large apple, and is of a dull yellow, spotted, and streaked with red. The mode of culture most likely to suit it, is as follows:—

1. Pot the plant in a very rich light loam mixed with about a fourth of very rotten horse-dung, and drain well with broken potsherds.
2. Always cramp the roots in small pots until the plant shows a disposition to flower, then re-pot them in a good rich soil and give them plenty of pot room.
3. Place the plant in a house where the thermometer ranges from sixty to eighty degrees, and allow it to be partially shaded from the sun's rays by other



THIS PAGE IS LOCKED TO FREE MEMBERS

Purchase full membership to immediately unlock this page

DELVE INTO FANTASY, MAGIC, MYTHOLOGY & FOLKLORE

Forgotten Books'
Full Membership gives
access to 797,885 ancient
and modern, fiction and
non-fiction books.

Continue

*Fair usage policy applies

Through the liberality of Mr. C., we are enabled to insert the following figures of four additional vases, equally novel in appearance and simple in structure with the preceding ones. Of their structure we need only say little here, sufficient having been already advanced in the volume above referred to; suffice it to say, that if any difficulty should occur to those who may wish to avail themselves of the plan, it will be speedily obviated by attending to and comparing the respective figures with what has been already said in explanation at the page above adverted to.

Fig. 1 is a most interesting object, especially when the branches of the plants have grown to a sufficient length to form a contrast with the flourishing directions of the rope, and a background for the showy flowers.

It may here be necessary to notice, that these stands or vases may be, with little trouble, taken away in the winter, and stored in a shed or other convenient place until spring, when they may be brought out to the situation they are intended to remain in during the summer; this being the case, a good opportunity is given to get the plants intended to grow in them well forward in pots, &c., and when the proper season arrives for putting out the vases, the

plants may be at once plunged into the soil, when they will almost immediately commence flowering. As vases or stands of this description will in many situations be subject to the parching influence of the sun, we recommend watering the plants two or three times successively in the evening; if the situation be partially or totally a shaded one, the plants will grow more vigorously, but will not produce so many flowers as they will if the warm and cheering beams of the sun are permitted to play upon them; but in the latter case they must have a great supply of water. If *Verbenas*, *Fuchsias*, *Anagallis*, *Petunias*, *Rhodichitons*, *Lophospermums*, or *Geraniums* are intended to be grown, they will be much better if well established, or even grown to a considerable size, in pots before planted out in the vase. Mr. Loudon has recommended stone vases, elevated on pedestals, as calculated to ensure the growth of herbaceous plants, &c., past the usual time such continue to exist in and about the smoky precincts of London; the advantage in this arises from the high station of the plants when planted in vases six or seven feet above the ground, in affording them a greater chance of enjoying the benefit of the sun, a greater circulation of air, and that in greater purity. To have herbaceous or annual plants in flower in front of dwelling houses in London, or any other large town, must be a very pleasing thing.

Fig. 1.

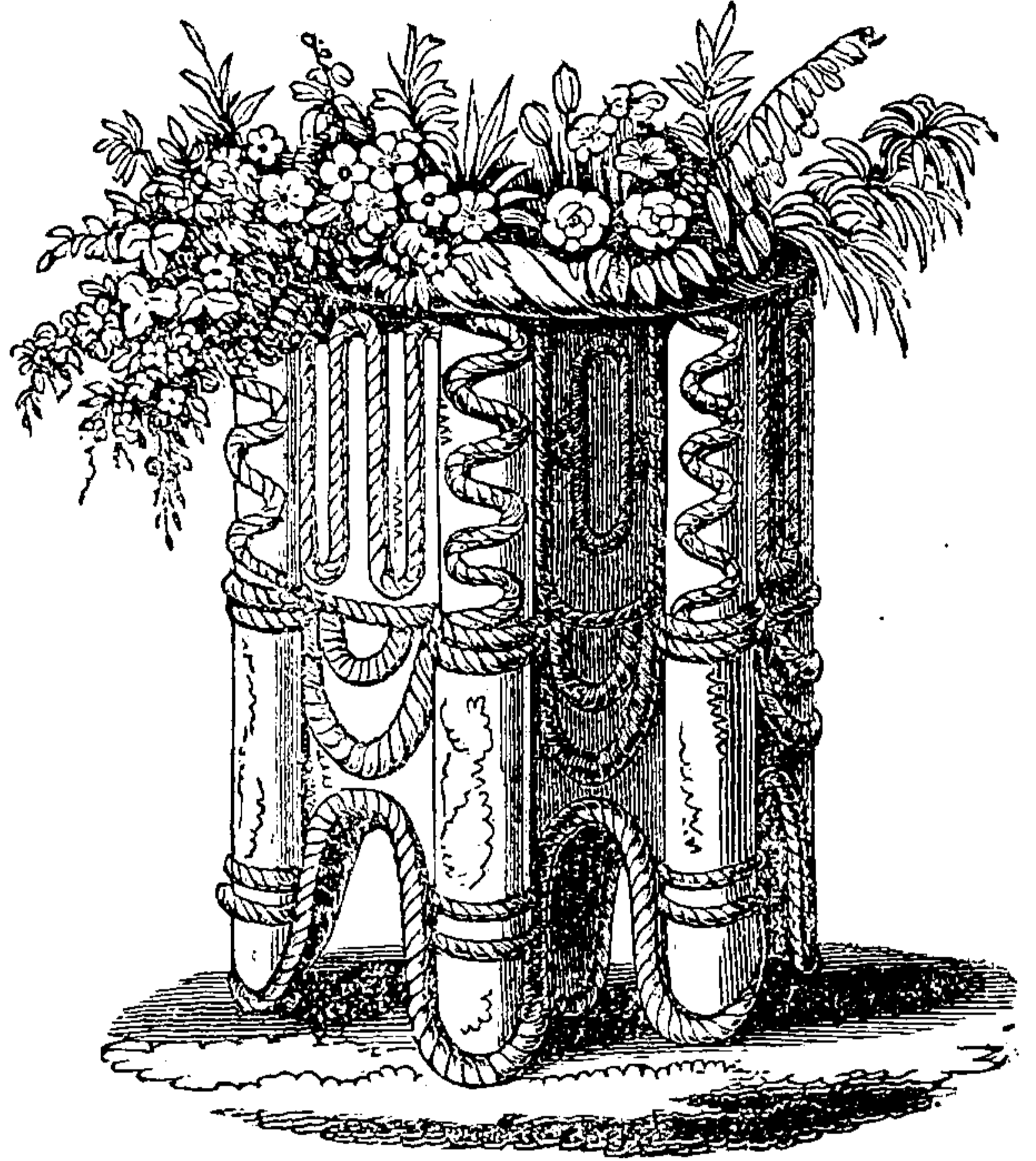

Fig. 2.

The following vase, fig. 2, we think would look well in such situations, providing the flower garden was not too small; and, if so, the vase might easily be constructed on a smaller scale, and thus adapt itself to the size of the garden.

In gentlemen's gardens, &c., in the country, it may, if a judicious selection of plants is made, and these properly planted and regularly attended to during their growth, be made very ornamental and interesting.

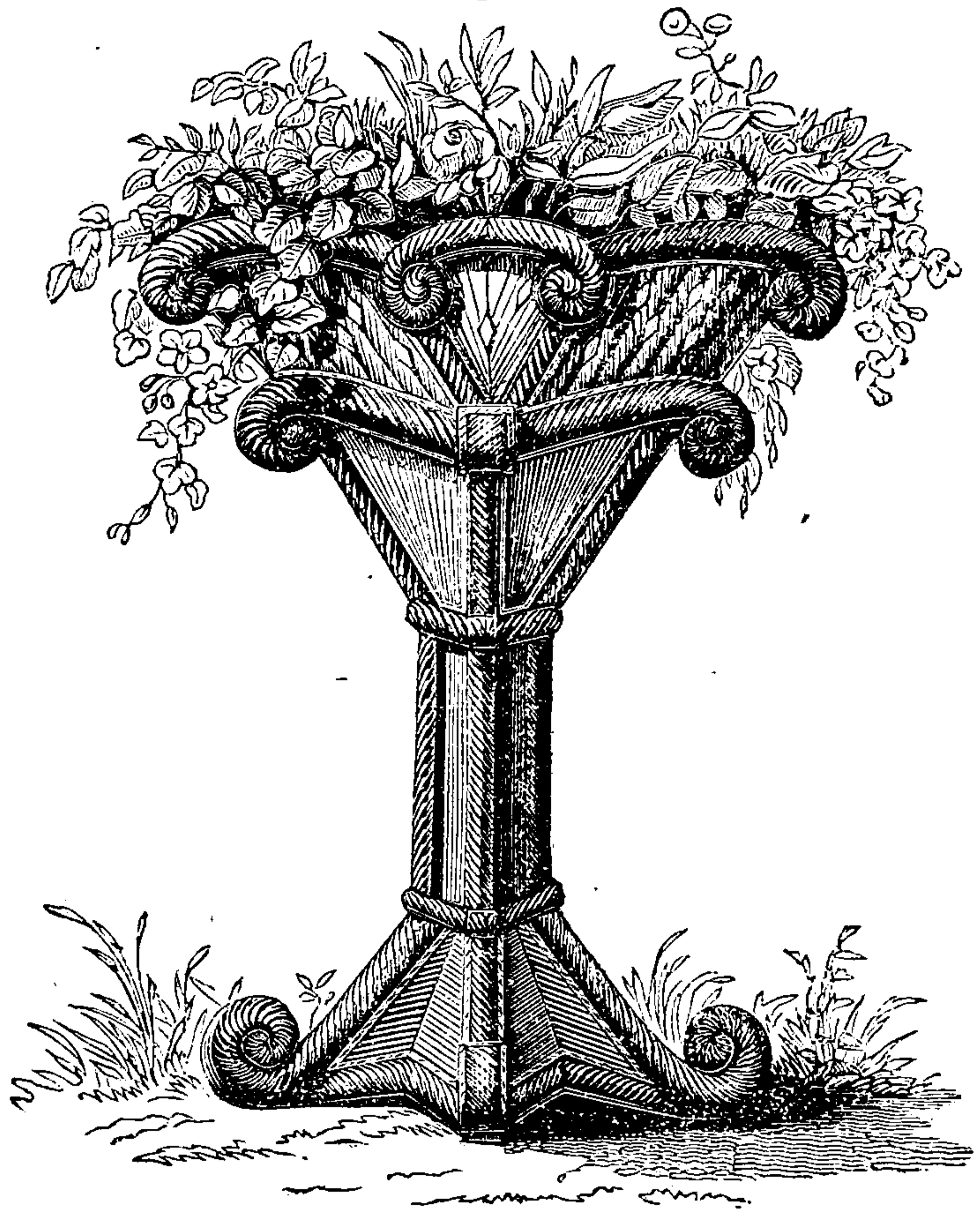

Fig. 3.

Fig. 3 may be considered a variety of the preceding, with which it makes an interesting contrast.

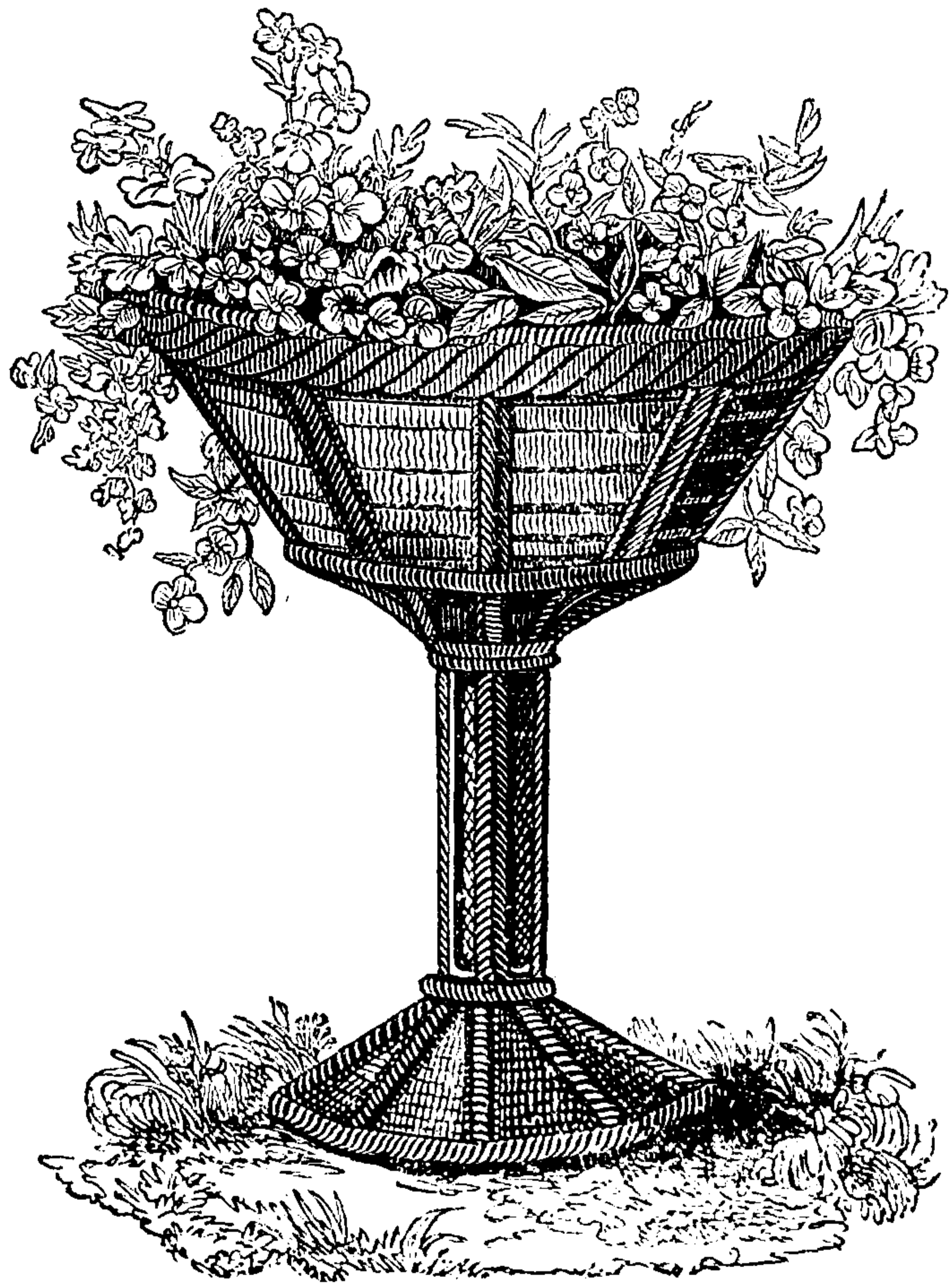
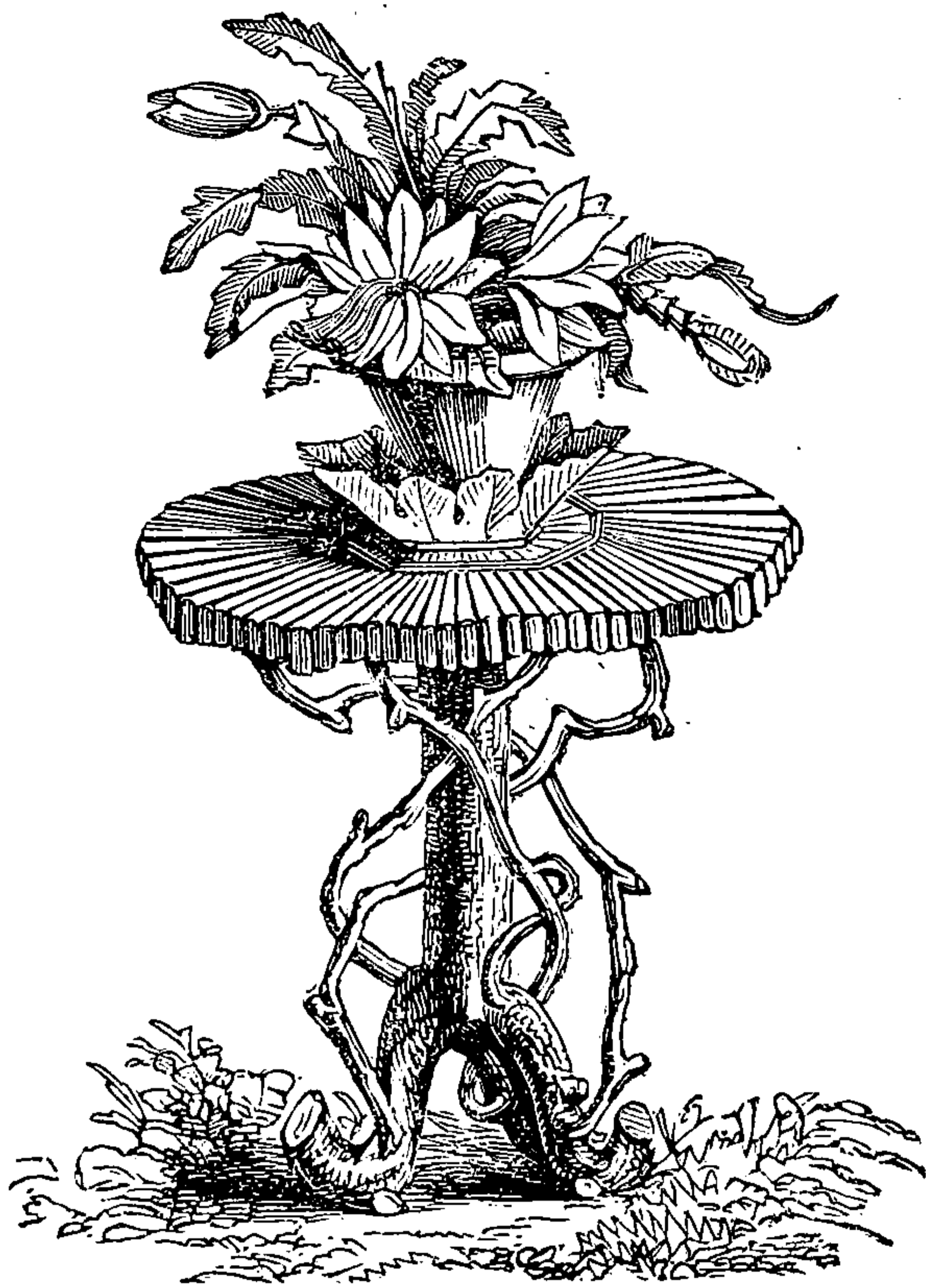

Fig. 4 is of a very novel structure, but is not adapted to grow such a variety of plants as the former. Any fine greenhouse plant, or two, or three, when in full bloom, might be placed in a pot in the receptacle at the centre of the table; and when the flowers fade, take the plants away and introduce others in their stead: this would have a pretty appearance, and keep up a lively interest the whole summer.

Fig. 4.



NEW AND RARE PLANTS,

FIGURED IN THE LEADING BOTANICAL PERIODICALS FOR FEBRUARY
AND MARCH.

BOTANICAL MAGAZINE. Edited by Sir William Jackson Hooker, LL.D., &c., each number containing eight plates; beautifully coloured 3s. 6d., plain 3s.; and corresponding letter-press.

BOTANICAL REGISTER. Edited by Dr. Lindley, each number containing eight figures, coloured 4s., plain 3s.; and corresponding letter-press.

BRITISH FLOWER GARDEN. Edited by David Don, Esq., professor of Botany in King's College, London, each number containing four plates; beautifully coloured, 3s., plain, 2s. 3d.; and corresponding letter-press.

Of the above plates, a selection has been made of such plants as are new or rare, and of the new ones, only such as are handsome, and deserve extensive cultivation. For fuller particulars, reference must be made to the works themselves.

CLASS I.—PLANTS WITH TWO COTYLEDONS (DICOTYLEDONEÆ).

THE INDIAN FIG TRIBE (CACTACEÆ).

PERESKIA ACULEATA. West Indian Gooseberry. This old and well-known plant has not been figured before in any English publication; a circumstance Dr. Lindley accounts for by its seldom flowering. The flowers form clusters of white



THIS PAGE IS LOCKED TO FREE MEMBERS
Purchase full membership to immediately unlock this page



Never be without a book!

Forgotten Books Full Membership gives universal access to 797,885 books from our apps and website, across all your devices: tablet, phone, e-reader, laptop and desktop computer

A library in your pocket for \$8.99/month

Continue

*Fair usage policy applies

THE BEAN TRIBE (LEGUMINOSÆ).

DESMODIUM CANADENSE. Canadian Desmodium. This beautiful species is quite hardy, and richly deserves a place in every flower garden, on account of its numerous racemes of handsome blossoms, which are produced in July. *Plant* nearly two feet high, erect; *leaves* pinnately trifoliate; *flowers* of a fine purple rose colour. *Bot. Mag.*, 3553.

LIMNANTHACEÆ.

LIMNANTHES DOUGLASII. Mr. Douglas's Limnanthes. This pretty hardy annual with white and yellow flowers, very fragrant, was discovered by Mr. Douglas, in California. It is of easy cultivation, and flowers in June and July. *Bot. Mag.*, 3554.

CLASS II.—PLANTS WITH ONE COTYLEDON (MONOCOTYLEDONEÆ).

THE ORCHIS TRIBE (ORCHIDEÆ).

ONCIDIUM LUNATUM. Crescent-lipped Oncidium. This very interesting and pretty little species of oncidium was imported from Demerara, by Messrs. Loddiges, in whose collection it flowered about June last. It is in some measure related to *O. Harrisonianum*, from which, however, it is abundantly distinct. The crescent-shaped lip is quite peculiar to this species; and the very blunt flat sepals conspicuously point it out. It may be treated like the other popular species of this genus. *Bot. Reg.*, 1929.

Among the smaller flowered species of this genus, the *O. lunatum* we deem extremely interesting; the flowers are small, with the parts well proportioned, the sepals and petals are of a lively yellow, blotched irregularly with dark orange brown, while the lip is nearly white, except a few pinkish spots, which run in a circular direction parallel with the margin of the lip. It appears to flower freely.

THE AMARYLLIS TRIBE (AMARYLLIDEÆ).

HIPPEASTRUM BREVIFLORUM. Short-flowered Knight's Star Lily. This distinct and handsome species blossomed in the stove of the Glasgow Botanic Garden, in April, 1836; bulbs of it having been previously sent there by Mr. Tweedie, from the neighbourhood of Buenos Ayres. The scape rises nearly three feet high, and is crowned by an umbel of six flowers, destitute of fragrance; externally they are tinged slightly with yellow green, and marked with a central broad red streak, vanishing below the middle within; the same red streak is separated by a white line down the middle. It requires the stove. *Bot. Mag.*, 3549.

THE LILY TRIBE (LILIACEÆ).

TULBAGHIA VIOLACEA. Violet-flowered Tulbaghia. This handsome flowering plant is a native of Southern Africa, and produces on an erect slender scape, which springs from the crown of the roots, an umbel consisting of from eight to nine flowers, of a shining bright purple colour, and very powerfully scented. *Bot. Mag.*, 3555.

Periodicals for March contain,

CLASS I.—PLANTS WITH TWO COTYLEDONS (DICOTYLEDONEÆ).

THE CROWFOOT TRIBE (RANUNCULACEÆ).

DELPHINIUM MONTANUM. Mountain Larkspur. This species is considered by Professor Lindley as one of the most handsome of the genus. It grows five or six feet high, is covered with soft green down, and its flowers, which are pale blue, are compactly arranged in simple branched racemes, sometimes as much as two feet long. Its roots are perennial, and it produces seeds abundantly. Its native country is the Alps of Central Europe. Professor Lindley proposes, for the benefit of Botany and Horticulture, to bring into notice, through the Botanical Register, the many little known though beautiful species of *Delphinium*. The plant is hardy, grows delightfully among bushes, and flowers in August. *Bot. Reg.*, 1936.

THE MALVA TRIBE (MALVACEÆ).

NUTTALLIA CORDATA. Heart-leaved Nuttallia. A worthy herbaceous plant, with neat foliage, and pretty pale pink flowers. The seeds were collected by Mr. Drummond, in North America. *Bot. Reg.*, 1938.

THE WATER-LEAF TRIBE (HYDROPHYLLACEÆ).

NEMOPHILA ATOMARIA. Speckled Nemophila. A new, but not very pretty, species of *Nemophila*, nearly related to the beautiful *N. insignis*, but entirely destitute of the brilliant blue in the corolla of that species. Independently of the small size of the flowers, and the want of blue, this species is to be distinguished from the *insignis* by the following characters. The leaves are less deeply cut, and their lobes are broader, and hardly ever divided into secondary lobes; the flower-stalks are rough with hairs, not smooth; the recesses of the calyx have much shorter appendages; the corolla is hairy, and strongly marked with numerous dull lead-blue specks, both on the inside and outside; the style, too, is longer and rather hispid. The seeds were sent from the Imperial Garden at St. Petersburg, and probably gathered in California. *Bot. Reg.*, 1940.

THE COMPOUND-FLOWER TRIBE (ASTERACEÆ, OR COMPOSITÆ).

MORNA NITIDA. The Beautiful Morna. This is a lively perennial plant, with its starry heads of the richest and most transparent yellow, having quite a metallic brilliancy, when illuminated by the sun. It may indeed be said, that *Elychrysum bracteatum*, and *bicolor*, are more showy; but they, altogether, want the delicacy of Morna, while the latter is destitute of none of their richness and brilliancy. It was found inhabiting the dry country about the Swan River, whence it was introduced in 1835, by Sir James Stirling. It was first brought into notice in this country by Robert Mangles, Esq. *Bot. Reg.*, 1941.

THE CACTUS TRIBE (CACTEÆ).

ECHINOCACTUS MAMMILLARIOIDES. Mammillaria-like Echinocactus. This fine species was introduced by Mr. Hitchen, from Chili, and is intermediate

between *Mammillaria* and *Echinocactus*. It is covered with mammillæ of a large size indeed, but these are arranged in costæ, which are irregular, and slightly spiral; the flowers are quite those of *Mammillaria*. The flowers are produced in abundance, and are rather durable; each petal is marked with a line of pink down the centre, and, contrasted with the remaining yellowish white, gives the whole a striking and pleasing appearance. The figure was furnished by Messrs. Mackie, of the Lakenham Nursery, near Norwich, from their rich collection of succulents. *Bot. Mag.*, 3558.

ECHINOCACTUS MACKIEANUS. Mr. Mackie's Echinocactus. This species is also from the rich collection of Messrs. Mackie, and, like the preceding species, has a considerable affinity with the genus *Mammillaria*; but is a much more neatly made and elegant species; the flowers are also represented as being paler. It is also considered to be a native of Chili. The treatment of the genuine *Echinocacti* suit it, but it is of slower growth, and more difficult to cultivate. *Bot. Mag.*, 3561

BEGONIACEÆ.

BEGONIA OCTOPETALA. Eight-petalled Begonia. This truly fine tuberous-rooted species of Begonia was sent from Lima, in 1835, by John M'Lean, Esq., to the Glasgow Botanic Garden, where the large flowers, so much like those of *Anemone vitifolia*, were produced in the stove during the months of October and November. It flowers best if placed in a warm part of the stove. *Bot. Mag.*, 3559.

CLASS II.—PLANTS WITH ONE COTYLEDON (MONOCOTYLEDONEÆ).

THE ORCHIS TRIBE (ORCHIDEÆ).

EPIDENDRUM CHLOROLEUCUM. Green and White-flowered Epidendrum. This species, which was introduced from Demerara by John Allcard, Esq., very strikingly resembles *Epidendrum odoratissimum*; and, like it, has long ovate bulbs terminated by two leaves, from between which arises the scape, bearing green and white flowers, but no fragrance. Culture the same as for other species. *Bot. Mag.*, 3557.

CHYSIS AUREA. Golden-flowered Chysis. This is a very showy plant, the colours of the flower (yellow and crimson) being very bright, its texture firm, and its surface even and waxy. The lip, with its crimson veins and narrow elevations radiating from the base, is especially worthy of attention. It was collected in 1834, by Mr. Henschman, in the valley of Cumancoa, in Venezuela, and flowered in the rich collection of Mr. Low of Clapton, also in that of Mr. Bateman's at Knypersley. In the morning it has a very delicate perfume, which it appears to lose in the heat of the day. *Bot. Reg.*, 1937.

BULBOPHYLLUM BARBIFERUM. Bearded Bulbophyllum. A most curious plant, introduced from Sierra Leone, by Messrs. Loddiges, with whom it flowered in June, 1836. It grows pretty freely under the hot damp system of cultivating epiphytes.

That a drawing is altogether incapable of representing such a strange conformation as exists in this species, will be evident in the course of the following



THIS PAGE IS LOCKED TO FREE MEMBERS

Purchase full membership to immediately unlock this page

DELVE INTO FANTASY, MAGIC, MYTHOLOGY & FOLKLORE

Forgotten Books'
Full Membership gives
access to 797,885 ancient
and modern, fiction and
non-fiction books.

Continue

*Fair usage policy applies

of this well known and much admired species is now producing its brilliant scarlet-coloured blossoms in great abundance. Messrs. Henderson have a brilliant display of forced flowers, such as *Roses*, *Azaleas*, *Pelargoniums*, &c., and these being all brought into the show-house, and there tastefully arranged according to their size, present to the eye a most lovely and fascinating appearance, while the odour that is exhaled from the *Hyacinths*, *Narcissuses*, &c., delights the senses, and almost leads one to imagine that they were in a paradise. *Nemophila insignis*.—This elegant little annual is now beautifully in flower in the greenhouse, and justly merits a situation in every collection.

MR. KNIGHT'S, Chelsea. *Ipomæa Horsfalliæ*. This splendid stove-plant, which is deservedly esteemed as one of the best climbing plants at present known to our collections, is now producing its brilliant crimson-coloured blossoms in the orchideæ-house of Mr. Knight, where it seems to thrive remarkably well, and we should certainly consider that any collection of stove-plants would be deficient without this highly beautiful and ornamental plant. *Pereskia Bleo*.—This is another stove-plant of great beauty, and is now in flower in the above-named nursery, where also there is an excellent stock of plants of this species. Mr. Knight has also a new and very pretty species of *Cypripedium* now in flower, the flower of which is of a pale pink colour, and is distinct from any we have yet seen; it was imported by Mr. Knight some time ago from Canada, along with many other species of *Cypripedium* and *Sarracenia* which have not yet flowered. Good blooming plants of the *Rhodora Canadense* are here and there interspersed among the greenhouse plants in the conservatory, which have a very pretty and pleasing appearance.

MESSRS. LODDIGES', Hackney. Nothing can exceed the peculiar beauty with which some of Messrs. Loddiges' orchideous plants are now flowering; for instance, those two elegant species of the genus *Dendrobium*, viz. *D. Pierardi* and *pulchellum*, are now producing their charming blossoms in greater perfection than we have ever before seen; large plants of each of these two species are suspended from the roof of the orchideæ-house, and their long slender stems are so completely covered with their exquisitely beautiful pink blossoms, as makes them appear at first sight to be one mass of flowers; but upon a nearer approach you begin to perceive the stems and foliage, which, being of a very delicate green texture, greatly add to the beauty of their appearance, and on the whole they present some of the most lovely objects which the eye ever beheld, or which the imagination could conceive. Besides the extraordinary beauty of these two species of *Dendrobium*, Messrs. Loddiges have many other beautiful orchideous plants now in flower, viz., *Oncidium pulchellum* and *pictum*, *Govenia pallida*, and various others; among which we noticed a good plant of *Myanthus deltoides*, which new and beautiful species is there flowering very profusely; but what took our attention most, was that it was suspended from the roof of the house, without anything to attach itself to, and in that state was thriving remarkably well; this is one among the many convincing proofs, that many species of this beautiful tribe of plants subsist wholly on air and moisture. To add to the beauty of Messrs. Loddiges'

orchideæ-house, it is richly ornamented, from one end to the other, with festoons formed by plants of the *Passiflora Kermesina*, which is now producing its superb crimson-coloured flowers in great perfection, and is a most delightful feature in a house of this description. Their large camellia-house is now becoming very attractive, as many fine specimens are now in flower, but the chief beauty of them is yet to come, as the greater part have not yet flowered.

MR. LOW'S, Clapton. Mr. Low has another fine specimen of *Camellia Doncklaerii*, beautifully in flower; also a good plant of *C. bicolor*, which is another new and beautiful species, and though perhaps the latter is not quite so good as the former, yet it nevertheless possesses a great share of beauty, and is, as well as the former, highly deserving a place in every collection. Mr. Low has an excellent stock of the *Chysis aurea*, which is a new, curious, and somewhat beautiful orchideous plant, and which no collection of this much admired tribe should be destitute of. The *Iris Chinensis*, an old but very beautiful stove-plant, is now flowering at the above nursery in great perfection, and makes a very excellent ornament to our stoves at this season of the year.

MESSRS. ROLLISON'S, Tooting. *Acacia pubescens*. A very fine plant of this beautiful species is now flowering in great profusion at this nursery, and has a very imposing appearance. Their orchideous plants are in a remarkably healthy condition, and promise fair to produce a good succession of flowers during the coming season; their house still looks very lively on account of the very fine specimens of *Oncidium luridum*, the flower spikes of which run along the top of the house, twine round the pillars, and assume various fantastical forms, producing their flowers in great abundance. The various species of this beautiful genus (*Oncidium*) are, we think, cultivated more successfully by Messrs. Rollison, than in any other collection we have ever witnessed. They have a fine plant of *Cyrtopodium Andersonii* now in flower, and one of the *Monochanthus viridis*, as well as some others of less importance.

MR. YOUNG'S, Epsom. *Rhododendron Cunninghamii*. This is, we believe, a new species of this extensive genus, which, although it has within the last few years received many valuable additions, yet the species now before us seems to surpass even *R. arboreum* in the richness and beauty of the colour of its flowers; it is now flowering very freely at the above nursery, and is a most valuable addition to our present stock of the greenhouse species of this much admired genus. Besides the above, Mr. Young has several very good hybrid varieties of *Rhododendron* now in flower, which are well worthy of notice. *Sisyrinchium grandiflorum*—this beautiful little plant is now producing its elegant purple blossoms in great abundance, and is admirably adapted for filling a situation in the greenhouse, among other early flowering plants.

OPERATIONS FOR APRIL.

ANNUALS (tender) for a main crop, may now safely be sown on a gentle heating hotbed under a frame; it is best to sow the seed in small shallow drills drawn out with the finger, and as soon as the young plants appear above the soil, tilt the lights a little, back and front, on fine days, and as they progress raise them a trifle higher until the plants get into rough leaf, when the lights may be taken off altogether. Stiff soil should be rejected, and very open rich soil preferred.

ANNUALS (half-hardy). If the weather be fine, the seed may be sown about the middle of the month, on a warm south border, but if not, the operation should be deferred until the latter end; for, as they are to flower where sown, it is better to wait a week to avoid dashing rains, than to have the seed washed up, or perished from too much moisture.

ANNUALS (hardy). A plentiful sowing should be completed early in this month.

AURICULAS should be protected from bad weather, as they will sustain injury; it is better to elevate the pots on a little platform, about a foot and a half or two feet high, than to keep them in frames, as they delight in having a circulation of air about them.

BIENNIALS should be sown immediately, as should perennials.

BULBS of different kinds, coming into flower, will now require much attention.

CAMELLIAS, if it be desirable to have a few plants in flower in the autumn, last season's flower-buds should be taken off and the plants potted, and put into a good heat, where they should be syringed frequently, in order to excite them to shoot.

GREENHOUSE PLANTS should now have a free circulation of air from all the moveable ventilators; and the different kinds desired to be increased, should now be propagated. Be cautious not to let the cuttings get very moist, and they will soon make root.

ORANGE TREES. It will now be well to stimulate into action; any that do not start freely, should be put in a little heat, and occasionally washed over the leaves and branches.

STOVE PLANTS continue to pot and propagate.

SUCCULENTS. Propagate any time this month; they root without difficulty from cuttings, if they are a little dried before planting. Water growing plants carefully.

TUBEROSES may sometime, this month, be put in to succeed those already in progress; give them plenty of pot room, and use good rich loam mixed with well-rotted dung.



THIS PAGE IS LOCKED TO FREE MEMBERS
Purchase full membership to immediately unlock this page



Never be without a book!

Forgotten Books Full Membership gives universal access to 797,885 books from our apps and website, across all your devices: tablet, phone, e-reader, laptop and desktop computer

A library in your pocket for \$8.99/month

Continue

*Fair usage policy applies









THIS PAGE IS LOCKED TO FREE MEMBERS

Purchase full membership to immediately unlock this page

DELVE INTO FANTASY, MAGIC, MYTHOLOGY & FOLKLORE

Forgotten Books'
Full Membership gives
access to 797,885 ancient
and modern, fiction and
non-fiction books.

Continue

*Fair usage policy applies

an agreeable fragrance, we shall have said that it is one of the most interesting of the tribe that has yet made its appearance."

It seems to prefer a hot and rather humid atmosphere, and to be placed so as not to receive the direct rays of the sun. We have a plant at Chatsworth, in a little hot-house devoted to the growth of some choice species, where the atmosphere is kept as recommended above, at a temperature varying from 75 to 80 degrees Fahrenheit, which thrives well; it is potted in peat earth, mixed with broken potsherds, so as to drain off the water freely; the roots are kept moderately moist, and the leaves are now and then sprinkled over with moderately warm water in the afternoon, when the house is finally closed. During the night, the temperature is kept generally a trifle above 65 degrees.

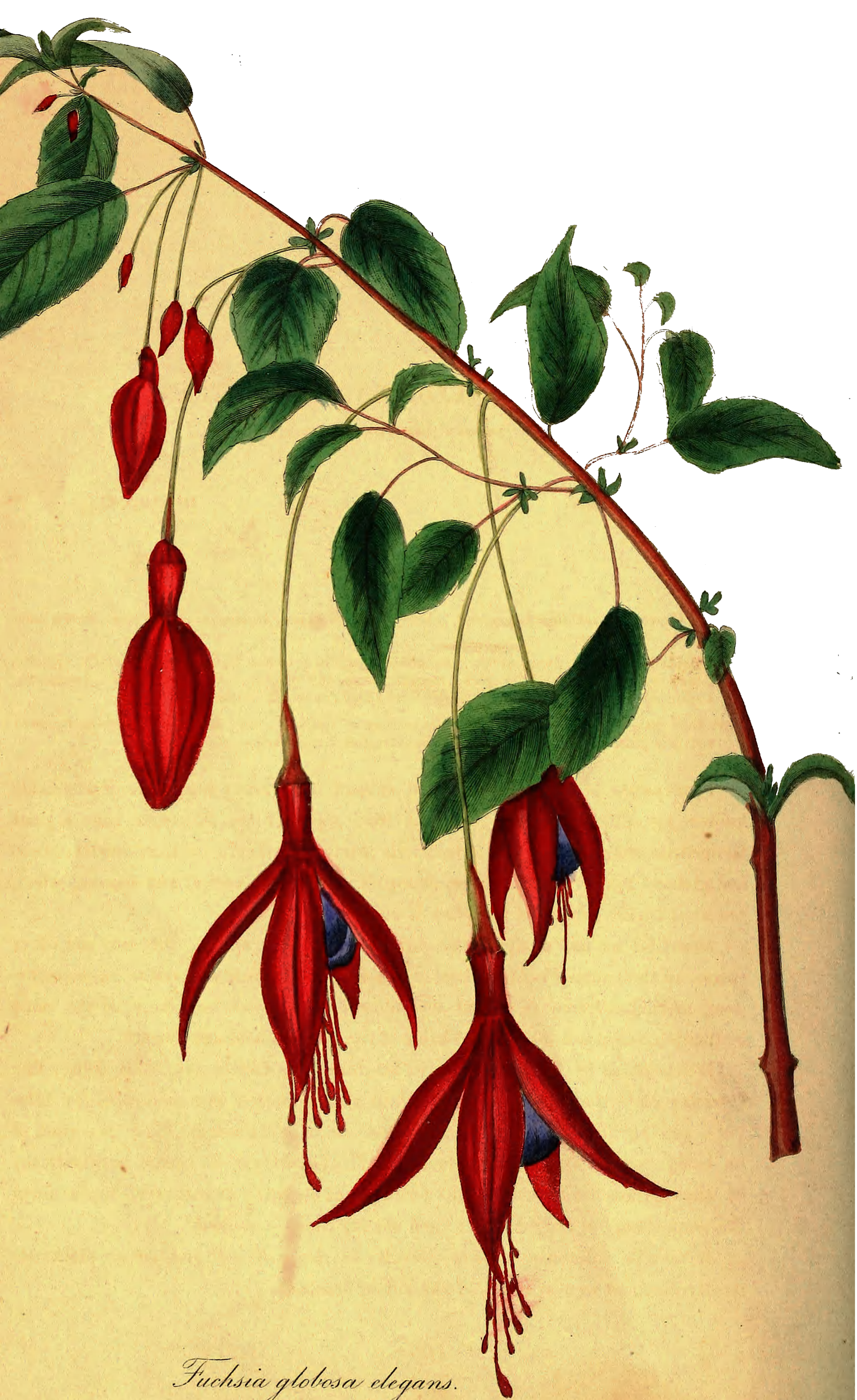

Fuchsia globosa elegans.

B. Mey. 1837.



THIS PAGE IS LOCKED TO FREE MEMBERS
Purchase full membership to immediately unlock this page



Never be without a book!

Forgotten Books Full Membership gives universal access to 797,885 books from our apps and website, across all your devices: tablet, phone, e-reader, laptop and desktop computer

A library in your pocket for \$8.99/month

Continue

*Fair usage policy applies

No plants contribute more to the gaiety or elegance of our flower gardens than those belonging to the genus *Fuchsia*, and there is perhaps no better way of showing their rich pendent flowers to advantage, than by grouping them, not over thick, in a bed of rich soil, in which they grow strong and produce a great profusion of large blossoms. We have seen them present a very striking and interesting appearance when trained upon neat trellis work against a wall.

The generic name was given in honour of Leoner Fuchs, a German botanist, author of " *Historia Stirpum.*"



Oncidium citrinum.

May 1837



THIS PAGE IS LOCKED TO FREE MEMBERS

Purchase full membership to immediately unlock this page

DELVE INTO FANTASY, MAGIC, MYTHOLOGY & FOLKLORE

Forgotten Books'
Full Membership gives
access to 797,885 ancient
and modern, fiction and
non-fiction books.

Continue

*Fair usage policy applies

ONCIDIUM CITRINUM.

(LEMON-COLOURED ONCIDIUM.)

CLASS.
GYNANDRIA.ORDER
MONANDRIA.NATURAL ORDER.
ORCHIDEÆ.

GENERIC CHARACTER.—*Lip* expanded, lobed, tubercled at the base. *Petals* spreading, sometimes only four. *Column* winged. *Pollen masses* two, two lobed behind, fixed by the middle to the common process of the stigma.—LOUDON'S *Ency. of Plants*.

SPECIFIC CHARACTER.—*Plant* a stove Epiphyte, with oblong compressed pseudo-bulbs, surmounted by two sword-shaped rather stiff leaves. *Scape* simple. *Sepals* and *Petals* linear-oblong undulated. *Labellum* dilated, appearing as if half bifid. *Stigma* round.

THIS, although not so handsome as other, but less rare, species of the genus *Oncidium*, is, nevertheless, highly worthy of a place in the most select collections, on account of its bold appearance and pretty lemon-coloured flowers. Messrs. Loddiges, to whom we are indebted for its introduction, received it from Trinidad in 1835.

Like the rest of the species, it requires a hot humid atmosphere: it is rather a shy grower, therefore must be treated with great care: one thing particular must be strictly adhered to; that is, never to over water it at the roots.

Dr. Lindley has pointed out the following characteristics as necessary to distinguish this species from *O. altissimum*. “Its flowering stem is simple and not branched; its flowers are of a pale lemon colour, very distant from each other, and by no means so much spotted; the crest of the lip consists of about eight warts, which are slightly downy, and not of nine smooth finger-like processes; its stigma is nearly orbicular, and not long and narrow, and the wings of the column are exceedingly small; and, finally, both the pseudo-bulb and the leaves have a singularly yellow tint.”

The generic name is given in reference to the tumours or prominences which appear on the disc of the labellum.



THIS PAGE IS LOCKED TO FREE MEMBERS
Purchase full membership to immediately unlock this page



Never be without a book!

Forgotten Books Full Membership gives universal access to 797,885 books from our apps and website, across all your devices: tablet, phone, e-reader, laptop and desktop computer

A library in your pocket for \$8.99/month

Continue

*Fair usage policy applies



Russelia juncea.

S. Holden, del.

Mag.



THIS PAGE IS LOCKED TO FREE MEMBERS

Purchase full membership to immediately unlock this page

DELVE INTO FANTASY, MAGIC, MYTHOLOGY & FOLKLORE

Forgotten Books'
Full Membership gives
access to 797,885 ancient
and modern, fiction and
non-fiction books.

Continue

*Fair usage policy applies

house, where the thermometer ranges between fifty and sixty degrees, except in the summer, when it of course in hot weather rises higher. It delights in good sandy loam mixed with about one-third peat and a little sand. It should have plenty of pot room, and when growing a good supply of water. It is advantageous in growing plants of this species to syringe them frequently, in order to prevent the appearance of insects, as they are rather subject to the ravages of these intruders if not attentively watched. Young plants are obtained with great facility from cuttings of the half-ripened branches, simply prepared, and put in a pot of sand, or sandy mould, with a glass over them, and the pot put in a little bottom heat. It may be easily procured of any of the London or country nurserymen that trade in hot-house plants.

The generic name is given after Dr. Alexander Russel, an English physician, who resided for some years at Aleppo, and published an account of his observations upon the Natural History of that place, in the year 1756.

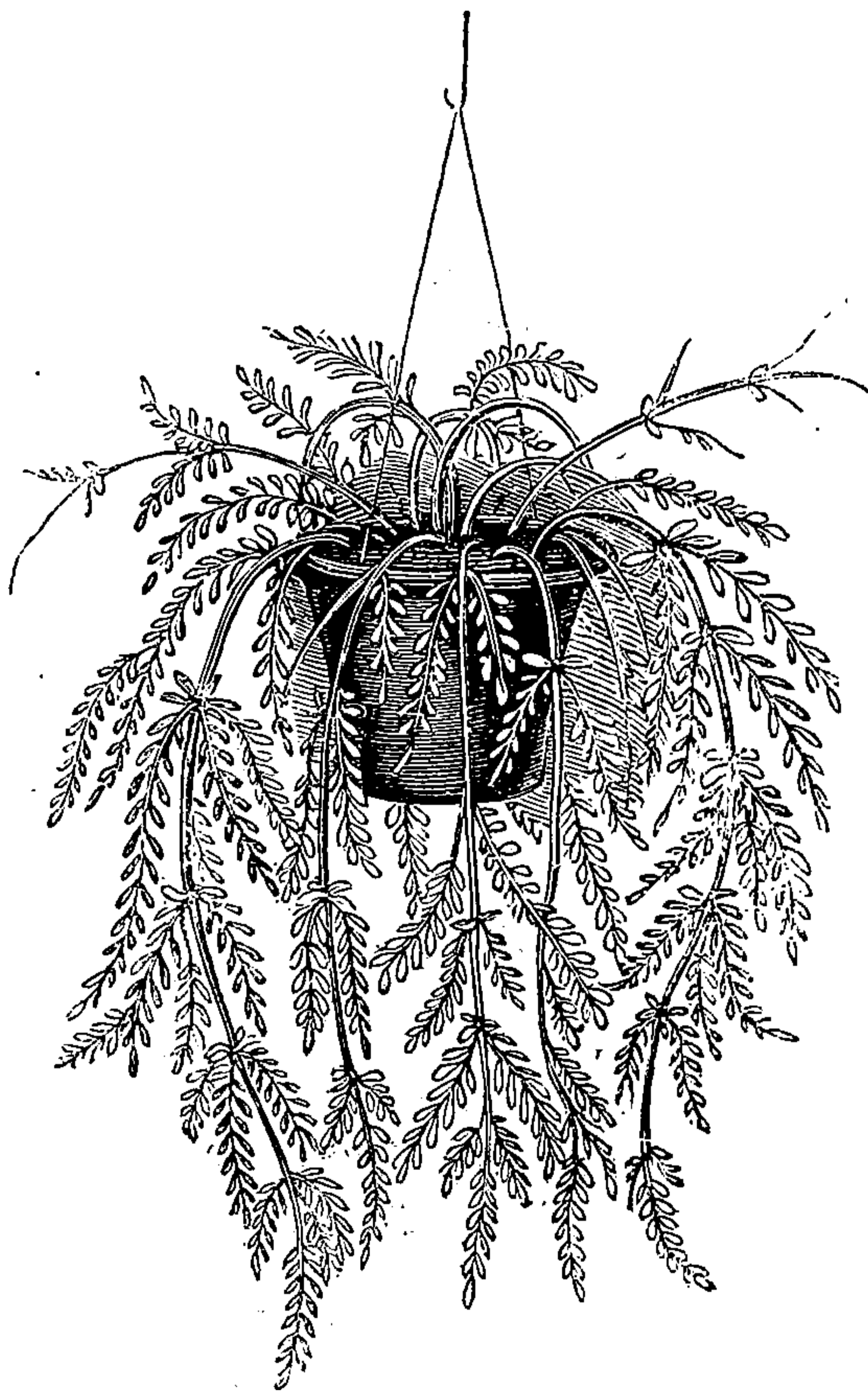

STREPTOCARPOS REXII.

IT is somewhat extraordinary that this plant, which certainly is one of great beauty and interest, should rarely be seen in our stoves or greenhouses; two or three years ago it was frequently to be met with, but we do not recollect to have seen it since 1834. There is a fashion in all things, and novelty as respects flowers is now a complete mania.

The subject of our present article was, it appears, introduced from the Cape of Good Hope in 1823; it first was called *Didymocárpos Rexii*, from an idea perhaps that the capsule or seed-vessel was twin or double, or composed of two capsules spirally twisted together, and it laid the foundation and formed the type of a natural order, named *Didymocarpeæ* (see Hooker's exotic Flora, No. 227). It was then referred to the Linnean Class, *Didynamia*. Subsequently, however, it has been removed from the fourteenth to the second class, *Diandria*, and occupies a place in the natural order, *Bigoniaceæ*. (See Loudon's Hort. Br. p. 468, No. 3279.)

The title *Streptocárpos* has been correctly bestowed on the plant, by Dr. Lindley, on account of the peculiar structure of its seed-vessel, which consists of two flattened, coloured, elastic straps, involving several fibrous processes, rolled or twisted together spirally. This capsule is several inches long, borne on the summit of a still longer flower-stalk, and contains a great profusion of very minute seeds, every one of which appears to be fertile, even if produced in November and December. The plant is a very abundant and continuous blower, its flowers appearing very early, and opening in rapid succession till nearly the close of the year. They are almost white, relieved with beautiful stripes of a deep purple tint, an inch and a half in length, with a long tube, and a somewhat irregular limb or border, cut into five segments. They rather resemble a *Gloxinia*, but have not the curved swelling throat of that flower.

The leaves are long, tongue-shaped, thick, rigid-intexture, and covered with close set hair or down, with which indeed the whole plant abounds from its earliest development.

The seeds speedily vegetate; and the first seed leaves (Cotyledons) rise in opposite parts, one much larger than the other, supported upon a minute stem, clothed with delicate silky pubescence. They advance very slowly in growth; continue throughout the winter in full verdure; and early in the spring the young plants appear as if they had but one leaf though two are present, the smaller being scarcely discernible unless minutely investigated. A pot of seedlings presents a curious object, the whole surface of the soil being covered by the larger elongating single leaves, lying in close contact one over the other. In this state they may be raised with great facility, by holding the leaf with the finger and thumb of one hand, while a small slip of wood or bone is passed under the plantlet, which brings up with it a certain quantity of soil that adheres to its delicate fibrous roots. Thus, plant after plant may be safely eased out, and transferred to very small pots, six or

eight in each; and we recommend that they be set very close to the edge of the pot, in order to increase the development of roots, and to admit of the second removal of every plant to pot with as great a quantity of mould as possible. This may be effected by cutting the soil from the circumference to the centre, exactly in the middle of the space between each plant, which will liberate an angular piece of soil, having a curved side, and in this the plant will be firmly fixed: thus no check will be experienced. The soil that produces the darkest, rich verdure, and the greatest expansion of foliage, appears to be a compost of sandy heath mould, three-parts of rich unctuous loam, and of perfectly reduced black leaf-mould, each one-sixth part, thus together constituting another fourth part of the whole. The mixture should be as complete as possible, and in this soft and genial medium the growth of the plant, from the seed to its period of flowering, may be established and perfected.

The flowers are usually produced singly, but occasionally two are supported on one stalk, but then, one of them is of diminished size. They are rather fugacious, being suddenly projected from the calyx, as if by the action of a spring. They remain perfect for some days, and may be dried and preserved of a pretty good colour.

Before the flowers expand, and from their first emergence in the bosom of the closely scaled leaves, the footstalk takes one curve, exactly like that of a French horn, at the summit under the calyx, but this curve is lost as the flower approaches to expansion.

The fertile stamens are two only, but there are rudiments of two others: hence, with the labiate form of the corolla, the plant first found itself among the Didynamous families, from which, however, it was finally removed.

The treatment is very simple; it requires a moderate stove heat (forty-five to fifty-five degrees) in winter, but will blow very well in the greenhouse, or window of a sitting room, during the warm months. Water should be given so as to maintain a regular free state of the soil; but a great quantity is not required.

GARDEN ARCHITECTURE.

ON THE VARIOUS FORMS AND CHARACTERS OF ARBOURS AS OBJECTS OF USE OR
ORNAMENT, EITHER IN GARDEN OR WILD SCENERY.

BY R. MALLET, ESQ. OF DUBLIN.

AN arbour is a space covered and enclosed by the interweaving branches of trees, and reticulated stems of climbing plants, generally but not necessarily situated in the midst of garden scenery, and intended to afford shade and retirement. The words arbour and bower are, properly, very distinct; the former alone designating the subject of the present article; and the latter, which is not derived from



THIS PAGE IS LOCKED TO FREE MEMBERS
Purchase full membership to immediately unlock this page



Never be without a book!

Forgotten Books Full Membership gives universal access to 797,885 books from our apps and website, across all your devices: tablet, phone, e-reader, laptop and desktop computer

A library in your pocket for \$8.99/month

Continue

*Fair usage policy applies

The same author seems to indicate that the laurel was not an unusual arbour plant in his time.

“ Tum spissa ramis laurea fervidos
Excludet ictus.”

Carm., Lib. 2. Od. 15, v. 9.

And as the bay (*Laurus nobilis*) thrives and grows to an astonishing height in Italy—as, for instance, that in the Borromeo islands, on the Lago Maggiore, on which Napoleon inscribed the word “ Battaglia,” the evening before Marengo, which is upwards of sixty-feet in height—it seems probable that it was this plant that was used. To the present day Italy is a land of bowers; the vines, all over the country, either hang festooned between the elms, as when Virgil wrote his Georgics, or are trained horizontally on flat trellises, to catch and intercept the sun, and thus form continual arbours: but we anticipate, to trace with laborious minuteness the history of arbours, would not be in place here; we therefore proceed to consider the various species of arbours, their modes of construction, the proper materials for their formation, their various styles, and their suitable localities.

Arbours may be divided into such as are purely natural, partly natural, and partly artificial, and such as are entirely the result of art.

Of the first are those formed by the banyan-fig, in tropical countries, whose lateral and widely-extended branches send down numerous shoots, which fix themselves in the ground; becoming stems, and forming

“ A pillared shade with echoing walks between.”

Such are those formed by our various weeping varieties of forest trees: the weeping ash, birch, beech, elm, willow, cyprus, &c., &c.

Fig. 1.

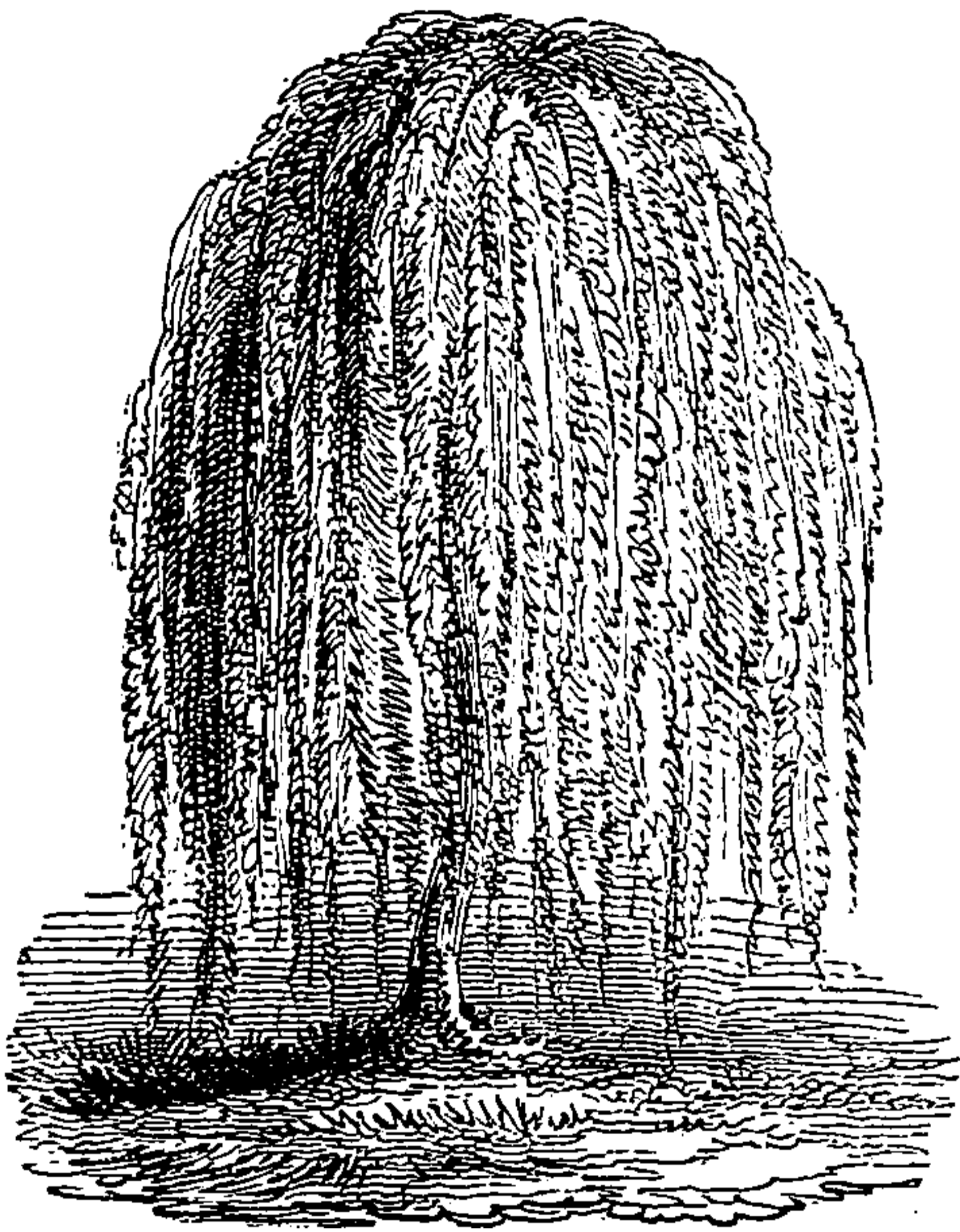

Fig. 2.



Figs. 1 and 2.—These with their lithe and tenuous branches waving with every summer breeze, and as here and there they sometimes part their textile boughs, and letting in the flickering sun-beam chequer the verdant floor with light and shade, are the most truly natural, and perhaps the most delightful, of any kind of arbour.

To the second kind belong all those which are formed by the hand of man, aided by some natural suitability of circumstances, or accidental advantages. Thus an aged forest tree may have some appropriate climbing plant placed at its root, so as to run through its branches and foliage, and ultimately descend gracefully from their extremities, until it nearly touches the ground, as in fig. 3.

The vast hollow trunk of an aged oak may be mantled with ivy, or with honeysuckle, and block seats placed within. To this order, likewise, belong those which are made by enclosing a space of any desirable form, perhaps circular, with the trunks of trees, choosing those which are roughest, and most moss-grown, fixing them firmly in close array in the ground, and closing in the arched top with their branches. Various climbing plants may then be planted at their bases

Fig. 3.

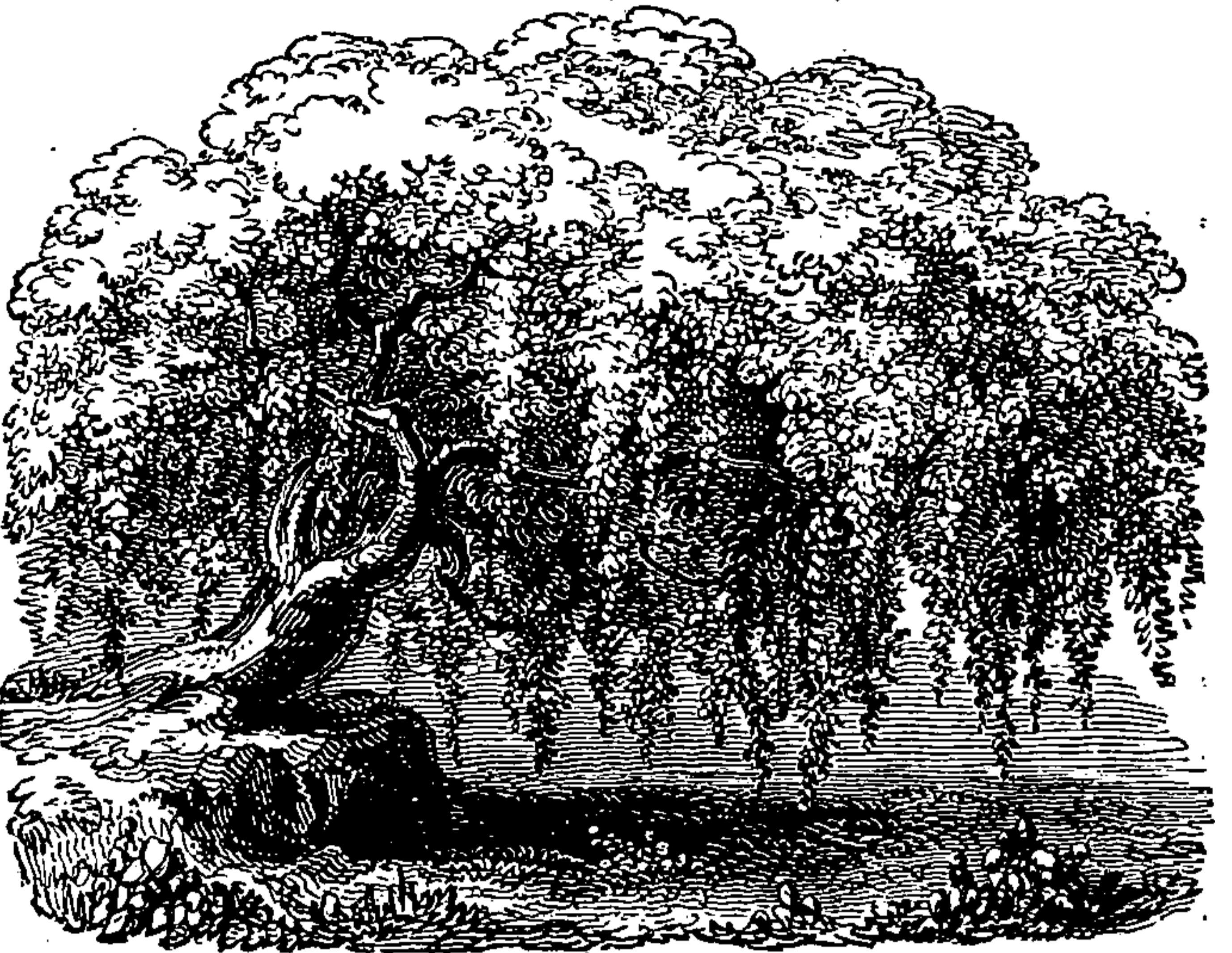

on the outside; amongst which ivy, in its varieties, should not be forgotten: these will soon cover over the whole with a dense envelope of foliage and flowers, while within, amongst the roots of the trunks and the block seats, primroses, violets, ferns, and other plants that love shade, and even some small American plants, will thrive.

Fig. 4.—The construction of this kind of arbour depends much on the chances of situation; and many designs, or minute instructions, would be, therefore, superfluous.

Arbours of the third kind are now but little used, indeed are scarcely to be seen in this country. They were usually formed with much attention to architectural outline of wood, or iron, or copper-wire trelliage; in the construction and arrangement of which much skill and money were often lavished. They seem to have had their origin in Italy, and thence to have passed into France. Lyster, in his

Fig. 4.

travels, anno 1698, gives descriptions of many which he saw. In the garden of the Hôtel d'Aumont, he says, "the trelliage at the upper end of the garden was very well adorned with gilding, and had in the middle a pavilion in which was an old Roman statue of a young man," &c., &c.

In the Hôtel Pelletier, "The garden here was very neat, with a trelliage at the end, after the manner of a triumphal arch. In

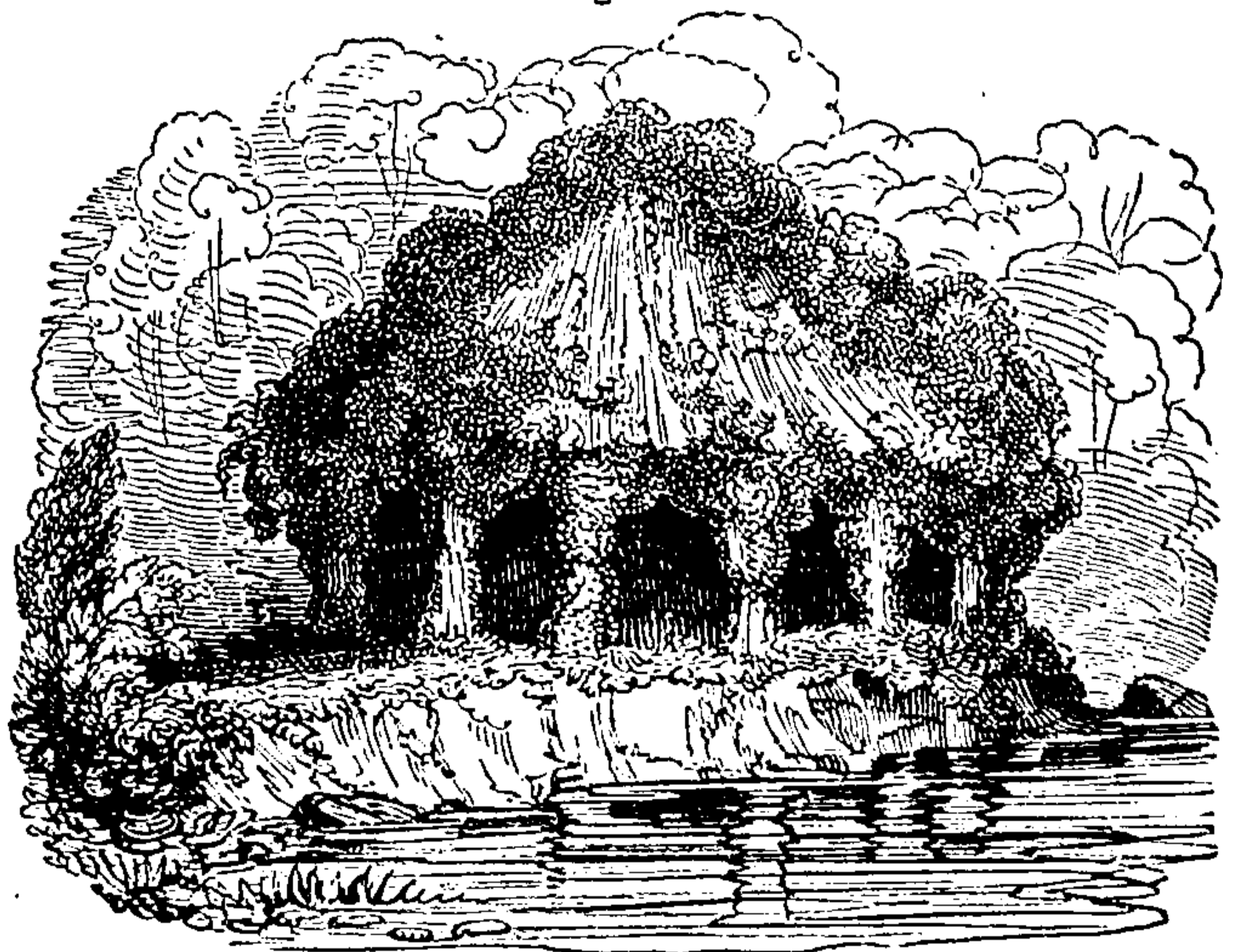

two niches were placed great iron vases of flower-pots, and right before the middle

a basin of water, which was set playing for our entertainment. Along the walls were planted apple trees, whose tops were disposed upon an iron trelliage into arches at equal distances, &c., &c. The best piece of trelliage of iron bars and wood intermixed, is in the garden of Monsieur Louvois. The whole upper end is adorned with a noble trelliage, after the manner of a triumphal arch: it cost a great sum of money. There are four statues disposed on pedestals under it; on one side of the trelliage is an aviary well stored with birds," &c.

We are also informed that pots of *Sédum pyramidale*, vases of iron with double red and striped stocks in them, and ranunculus brought at great price from Constantinople, formed distinguished ornaments of these arbours.

In his description of the gardens of St. Cloud he says, "There are many arbours of trelliage pavilions, &c., of iron mixed with wood, painted green, with honeysuckles running up to them." The tree most in use here is the small-leaved hornbeam, which serves for arcades, berceaux, &c. The marronnier, or horse-chesnut, is chiefly used for shady walks. He also says, that vast urns, or vases of trelliage, filled with some plant growing within them, and clipped to their form, formed a common accompaniment to the trelliage arbour.

These dry quotations show what was the style of arbour then in use, in which little alteration has since been made. The expense that was then gone to, however, in the gilding and decoration of these trelliages was incredible. Lyster mentions two which cost sixteen thousand livres.

The object in this was, that as during the severe winter, and the height of summer, the trelliage was nearly laid bare by the frost, or by the parching sun; so it was important to make it look well even then.

Fig. 5, is an example of the old French and Italian arbour.

The best and handsomest arbours of this class that we have seen, are those in the gardens of the Duke of Baden, at Schweitzingen, between the Rhine and the Maine. These gardens, attached to the ancient castle of the Marquesses of Baden (now only used as a hunting-lodge), are of considerable extent, and are filled with a profuse variety of ornament, in a mixed style, between the old French and the German.

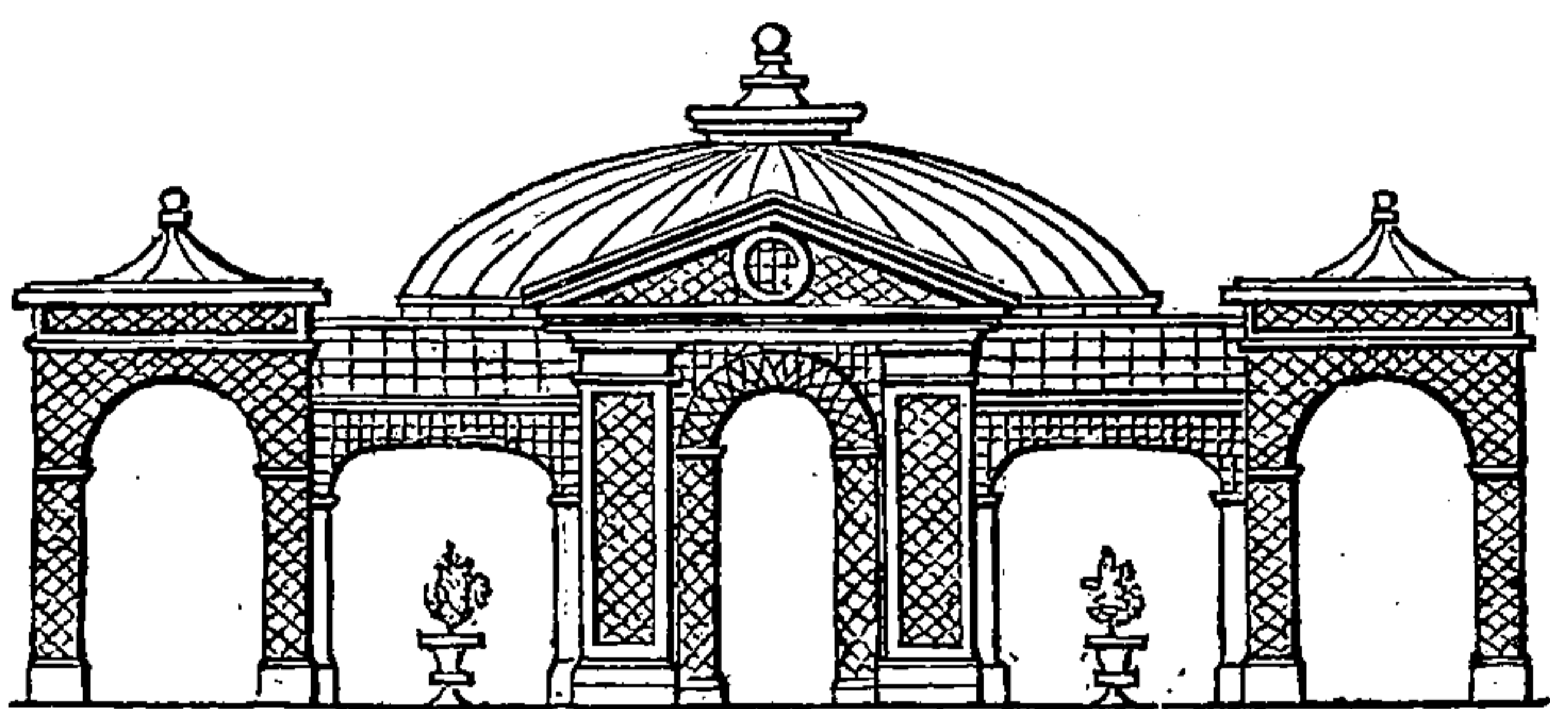

Fig. 5.

The great garden area immediately behind the castle, is laid down in a great circle, divided into various grass-plots, fountains, basins, &c., &c., all of respectable magnitude: the semi-circumference of the circle next the castle, is surrounded by hothouses, which form its extreme wings; but the remote semi-circumference is entirely surrounded by a broad walk, covered by an arched wooden trelliage, with equidistant arched openings all along the sides; these at one side permit a free view of the great circle with all its varied garniture, while at the other they open into a succession of close and secluded bowers.

The whole is uniformly and luxuriantly covered with the Virginian creeper (*Ampelopsis hederacea*)



THIS PAGE IS LOCKED TO FREE MEMBERS

Purchase full membership to immediately unlock this page

DELVE INTO FANTASY, MAGIC, MYTHOLOGY & FOLKLORE

Forgotten Books'
Full Membership gives
access to 797,885 ancient
and modern, fiction and
non-fiction books.

Continue

*Fair usage policy applies

A plant at Chatsworth, turned out after this manner about two years ago, produced a few good sized flowers, but they were much inferior to some produced the same season, on a plant about the same size, planted in a border in the greenhouse. No plant bears the knife better than this, and perhaps scarcely any other plant is so simply propagated. A one-year-old shoot taken off and the wood separated nearly from the eyes—say to within a quarter of an inch—and these put into a pot of soil and the pot plunged into a little heat, will each soon send up a strong shoot, if not over watered. A frame, where cucumbers or melons are growing, is an excellent place for them. They may also be successfully and easily propagated from cuttings made in the usual way, that is, by taking each cutting off at a joint, and putting the cut end in the soil; each way they succeed best with a little bottom heat.

NEW AND RARE PLANTS,

FIGURED IN THE LEADING BOTANICAL PERIODICALS FOR APRIL.

CLASS I.—PLANTS WITH TWO COTYLEDONS (DICOTYLEDONEÆ).

THE RANUNCULUS TRIBE (RANUNCULACEÆ) HELLEBOREÆ.

DELPHINIUM BARLOWII. This Delphinium presents to the eye the most gorgeous mass of deep lapis lazuli blue that Dr. Lindley is acquainted with in the vegetable kingdom. It is quite impossible to describe the effects of several plants growing in a cluster, and well backed up by species whose colours harmonise with the blue. The drawing was made from Messrs. Rollison's collection of hardy herbaceous plants, where the plant bloomed throughout the whole of summer and autumn, and it is said to be of easy cultivation. *Bot. Reg.* 1944.

THE FIGWORT TRIBE (SCROPHULARIACEÆ).

PENTSTEMON BREVIFLORUS. Short-flowered Pentstemon. A Californian perennial raised in the garden of the Horticultural Society from seeds picked off some of Mr. Douglas's dried specimens. In its native country it appears to be a stout branching plant, bearing a profusion of small white and purple flowers; but when cultivated, it has been found so tender and difficult to manage, that little of its native beauty is developed. It is hardy, and grows best in peat and loam, producing its flowers in September; increased from cuttings. *Bot. Reg.* 1946.

THE POPPY TRIBE (PAPAVERACEÆ).

CHRYSEIS COMPACTA. Dwarf Chryseis. The generic name *Eschscholtzia* it has been thought necessary to cancel, and substitute in its room the name *Chryseis*. The present species differs from *E. Californica* and *E. crocea*, now *C. Californica* and *C. crocea*, in having a more dwarf compact habit, the segments of the leaves very slightly toothed, instead of deeply lobed, and in the flowers being far smaller. It is a most beautiful flower, not much inferior to *C. crocea*. *Bot. Reg.* 1948.

BEGONIACEÆ.

BEGONIA MONOPTERA. Single-winged Begonia. This is one of the many species of this handsome genus, for which our stoves are indebted to Mr. Otto, of the Royal Berlin Garden. It was introduced from Brazil to that collection in 1826, by Mr. Deppe. This is a handsome and deserving species; the flowers are white, and consist of four petaloid spreading sepals; these, contrasted with the green leaves, and the latter again compared with the red stem and likewise red stalk of the leaf, present a very striking appearance. The flowers are produced in July. *Bot. Mag.* 3564.

THE INDIAN FIG TRIBE (CACTEÆ).

CEREUS SERPENTINUS. Serpent-like Cereus. This beautiful plant flowered in Mr. Mackay's nursery at Norwich, who describes it as a night-blooming species, and that the blossoms remain expanded about the same time as the *C. grandiflorus*; they are strongly scented, and the plant is more hardy than that species, but less so than the *Echinocacti*. The flowers are large, of a whitish flesh colour within, and reddish colour without. *Bot. Mag.* 3566.

ASCLEPIADEÆ.

CEROPEGIA STAPELI-FORMIS. Stapelia-like Ceropegia. This remarkable plant is probably a native of the East Indies, and should be grown in the stove, where it produces its extraordinary flowers about April. The corolla is two inches long; the tube curved, swelling below, and constricted just above the base, greenish white, spotted above and below with deep purple; the tube expanded upwards to form the limb, which is cut in five segments, dark purple without, and glabrous, white, and hairy within; they soon separate, and are curved backward, the sides are closely reflexed, so that the upper side presents a sharp keel, giving a very singular appearance to the blossom. *Bot. Mag.* 3567.

CACTEÆ.

ECHINOCACTUS SESSILIFLORUS. Sessile-flowered Echinocactus. This is a very pretty species. The beautiful short white and distinctly placed fascicles of spines form a singular contrast with the dark green of the plant, and, together with the short and much depressed stem, readily distinguish it from *E. Ottonis*. Mr. Frederic Mackie, whose skill and experience in horticulture are very great, observes, that he is very successful in flowering the different species of Echinocactus, by growing them very near the glass, and during the summer time in a very high temperature, by keeping the upper glasses of the house close; strong light and heat being necessary to expanding their blossoms in perfection. Some of them will close immediately on being removed to a cooler place. It is also very necessary to have the pots well drained, as the roots are liable to decay if the earth is at all soddened with moisture. I think that setting the free growing species in poor soil is quite a mistake, for we invariably find that they thrive better in good soil, provided it be well drained, and if they are planted in small pots. *Bot. Mag.* 3569.

THE NIGHT-SHADE TRIBE (SOLANÆ).

DATURA GUAYAQUILENSIS. Guayaquil Thorn-apple. This annual species has nearly white flowers, which it produces about February and March in considerable abundance; still it cannot be considered very desirable. It grows abundantly in moist places on the shores of the Pacific near Guayaquil. It has been treated in the stove, but it is thought that it will prove sufficiently hardy to occupy a place in the flower border during the summer months. *Brit. Fl. Gar.* 380.

ONAGRARIÆ.

CLARKIA GUAUROIDES. Guara-like Clarkia. This is a showy annual, but not so handsome as *C. pulchella*, or *C. elegans*. It was introduced by Mr. Douglas from California, and raised in the Horticultural Society's Garden in the spring of 1835. It is quite hardy, and grows well in common garden soil; seeds ripen freely. *Brit. Fl. Gar.* 379.

CLASS II.—PLANTS WITH ONE COTYLEDON (MONOCOTYLEDONEÆ).

THE ORCHIS TRIBE (ORCHIDÆ, EPIDENDRÆ).

LÆLIA ANCEPS; var. BARKERIANA. Mr. Barker's variety of *Lælia Anceps*. This variety of *Lælia anceps* is a native of Mexico, whence it was procured by Messrs. Low and Co. It flowered for the first time in this country in the rich collection belonging to George Barker, Esq., of Birmingham. It is in general appearance like *Lælia anceps*, from which it differs in two of the opposite ribs of its four angled pseudo bulbs being smaller than the other two, in its petals being so much narrower as to differ materially in size from the sepals, and in the middle lobe of the lip being both narrower and sharper. When the flowers first opened, the lilac of the sepals and petals was lighter, and possessed the transparent character of *Cattleya labiata*, but in a more striking degree. It will doubtless be easily cultivated upon the same plan as the *Cattleyas*. *Bot. Reg.* 1947.

ORCHIDÆ.

TRICHOCENTRUM FUSCUM. Brown-flowered *Trichocentrum*. This interesting species was imported from Mexico by Mr. Knight of the King's Road, with whom it flowered in July of last year. It is a stove epiphyte of easy cultivation. The plant grows much like *Oncidium pumilum*, but the leaves are more acute. The flowers are very striking and pretty; the petals and sepals are of a brownish green colour, while the lip is white, except a blotch of pink upon each side, from which a few streaks of yellow run through to its base. *Bot. Reg.* 1951.

MONACHANTHUS AND MYANTHUS CRISTATUS. In November 1836, His Grace the Duke of Devonshire was so kind as to put into my hands the extraordinary flower represented in the accompanying plate, which may be regarded as one of the greatest curiosities that our gardens ever produced. Accustomed, as botanists now are, to the freaks and masqueradings of nature, and to the strangest departures from all rules at every step among orchideous plants, there is certainly nothing upon record to be for a moment compared with the case before us. It is that of a plant



THIS PAGE IS LOCKED TO FREE MEMBERS
Purchase full membership to immediately unlock this page



Never be without a book!

Forgotten Books Full Membership gives universal access to 797,885 books from our apps and website, across all your devices: tablet, phone, e-reader, laptop and desktop computer

A library in your pocket for \$8.99/month

Continue

*Fair usage policy applies

NOTICES ON THE CULTURE OF NEW AND RARE PLANTS

IN THE PRINCIPAL NURSERIES AND PRIVATE GARDENS IN THE
VICINITY OF LONDON.

On the Culture of the genus Stapelia.

As many persons find great difficulty in managing this curious tribe of plants, and as we have seen them cultivated to very great perfection in the gardens of a private gentleman in the neighbourhood of London, the following hints on his mode of treatment may not be unacceptable to our readers.

The various species belonging to this genus are exceedingly liable to damp off, therefore the principal thing to be attended to, is to keep them perfectly dry during the winter months; and, as any artificial heat at this season will only prove injurious, it is best to keep them in a cold dry frame, taking care to preserve them from frost. The plants, whether old or young, should be removed from this situation about the middle of the month of March, and placed as near as possible to the glass, in a damp stove, where strong heat is kept up, watering them moderately and cautiously when necessary. Under this treatment their growth will be very rapid, and great care must be taken not to let them have too much water at the roots.

As soon as their growth is completed, which will be about the beginning of June, remove them to the back shelf of a pit, or the front stage of a greenhouse, where they will be sheltered from rain, and exposed to the full blaze of the summer sun. Here most of them will produce their flowers in July, August, or September. As autumn advances, let water, which was given moderately before, be entirely withheld, and the plants remain without any moisture till they are removed into the stove in the following March. During the winter season they should be exposed to the air freely; and if the temperature is allowed to get below 40 degrees, they will not sustain any injury thereby.

Plants thus treated will assume a dark purple hue, and perhaps shrivel a little, but will not be at all injured, and do not even lose a flower bud which may have formed late in the autumn. If any are very late before they flower, as is the case with *S. grandiflora*, *spectabilis*, and some others, they may be removed to a dry stove to bloom, and afterwards wintered with the others in a cooler place.

The various species of this genus may be propagated pretty readily by cuttings, which should be taken off from the young shoots as soon as they are well formed; these, like most other plants of a succulent habit, will require to be placed for a little time on a shelf in a dry stove, in order to dry up the excessive moisture they contain, as, if this is not done, they will be very liable to damp off; after the cuttings have become so dry as to begin to shrivel, they should be planted in large shallow pots, about an inch and a half apart, in a very sandy soil: or perhaps it would be better to plant them *singly* in very small (60 sized) pots; this done,

place them near the glass in a moist stove, and water them with great caution. Under this treatment they will soon strike root, when they should be potted into larger sized pots; the soil best suited for them is a light sandy loam, mixed with a little brick rubbish, which will require sifting; and it is indispensably necessary that they should be well drained, as, if they are once allowed to become saturated with water, they will die immediately.

Besides the above method of propagating by cuttings, many species of this genus naturally throw up a great many offsets or suckers; which, if taken off carefully, and potted immediately in small pots in the soil before mentioned, will grow very freely. Although the genus *Stapelia* has been subjected to many divisions, and although many of the original species of this genus have been referred to other genera, and in some instances have been made to constitute new genera, yet we have no doubt that the system above laid down will apply equally well to most of the species which originally constituted this genus, and which are now to be found under the genera *Tridentea*, *Tromotriche*, *Piaranthus*, &c.

We would just add that, although the cultivators of this curious and beautiful genus frequently find some difficulty in getting some of the species to flower, yet, under the above-named mode of treatment, the plants in the collection of the gentleman from whom we gathered the above remarks, produced their flowers last autumn in as great, or perhaps greater, perfection than we have ever before seen; and we have no doubt that if this system be more generally practised, it will lead to the same satisfactory results.

Mimosa prostrata.—This is a new and very pretty species of this extensive genus, and as far as we are aware has never yet been noticed in any of the periodicals. Its habit is naturally to throw its long slender branches along the ground; but if it be trained up the rafters of a greenhouse (for which purpose it is admirably adapted) it forms a most delightful and pleasing ornament. It is a remarkably free-growing plant, and, if trained as above, it will produce a great abundance of lateral shoots; these, if left to themselves, will naturally incline downwards, and when in flower its beautiful clusters of delicate pink blossoms, which, as they are produced on the lateral shoots, and as these are very slender, wave backwards and forwards from the wind produced by airing the house, have a most elegant and fascinating appearance. But our object in the present instance is to show, that in the nursery of Mr. Young, Epsom, where we believe this plant first appeared, it has usually been treated as a greenhouse climbing plant, and by most persons who possess it, it has generally been so considered; but Mr. Young, from a very laudable motive of endeavouring to prove whether it would endure the open air in this country, placed a plant of it last year against an open wall, in a sheltered situation, and he has found that it has succeeded admirably well; for during the very severe weather of the past winter, which has in many instances destroyed plants which have been considered perfectly hardy, this plant has withstood all the inclemency of the weather, and not had even so much as a leaf injured: from this we may reasonably infer that this beautiful plant is perfectly hardy, and it will undoubtedly prove a most delightful feature in any collection of hardy ornamental climbing plants.

NOTICES OF NEW AND RARE PLANTS

IN FLOWER IN THE PRINCIPAL NURSERIES AND PRIVATE GARDENS IN THE VICINITY OF LONDON.

MESSRS. HENDERSON'S, Pine-Apple Place. *Azalea Indica Smithii*. Amongst the almost endless beautiful species and varieties of *Azalea* now common to our collections, this is certainly very far from being one of the most unworthy of notice; on the contrary, it is a most splendid and valuable variety, and one that justly merits a place in every collection. Messrs. Henderson have a particularly fine plant of it now most brilliantly in flower. *Rhodanthe Manglesii*.—This charming new annual is now flowering profusely in the greenhouse of the above nursery, and no collection, however small, should be destitute of it, as it may be made to flower at almost all seasons of the year. Messrs. Henderson's show-house is still remarkably attractive, and they have forced flowers of all kinds in very great perfection.

MR. KNIGHT'S, Chelsea. Mr. Knight has now in flower a most splendid new *Amaryllis*, which he has raised from seed; the flowers are very large, of a white ground, and beautifully pencilled with delicate pink-coloured stripes; and of the many beautiful species and varieties of this extensive and much admired genus now extant, we think that there is none more deserving of a place in a good collection than the present one. *Azalea Indica variegata*.—This splendid new variety of *Azalea* has recently flowered in the above nursery in great perfection, and promises again to produce its beautiful blossoms in a short time. Mr. Knight has also two or three other new varieties of *Azalea*, which are exceedingly beautiful, and any collection of this much admired genus would certainly be deficient without them. The *Ipomæa Horsfalliæ* is still exhibiting its beautiful blossoms, and there are several good orchideous plants now in flower, particularly a very fine specimen of *Lessochilus speciosus*. Mr. Knight has recently made a considerable accession to his stock of *Orchideæ*, by new importations, among which there appears to be several things which have not before been introduced to this country, and some very fine specimens of *Cattleya*, some of which will very probably be new and valuable. Several new species of *Sarracenia* have flowered with Mr. Knight during the past month, which are part of an importation he made some time ago from Canada; some of them were very distinct, and well worthy of notice.

MESSRS. LODDIGES', Hackney. *Saccolobium præmorsum*. Notwithstanding the many beautiful species that now exist belonging to that highly interesting order *Orchideæ*, we think that we hardly ever met with one to excel, in point of real elegance, the one now before us; it bears some resemblance to *S. guttatum*, but is decidedly superior to it; the flowers are produced on racemes, which proceed from the axilla of the leaves, and depend downwards; the ground colour of the flowers is white, but they are most beautifully blotched with a delicate rosy lilac. A fine plant in the collection of Messrs. Loddiges is now producing two large racemes of flowers; the flowers grow so closely together on the raceme as entirely to hide



THIS PAGE IS LOCKED TO FREE MEMBERS

Purchase full membership to immediately unlock this page

DELVE INTO FANTASY, MAGIC, MYTHOLOGY & FOLKLORE

Forgotten Books'
Full Membership gives
access to 797,885 ancient
and modern, fiction and
non-fiction books.

Continue

*Fair usage policy applies

would certainly be a most desirable acquisition to any collection. Mr. Young has a very pretty new orchideous plant now in flower, and from the appearance of its flowers, and their resemblance in shape to most of the species of *Cattleya*, we should certainly think that it is a new species of *Cattleya*: the flowers are of a very deep orange colour, approaching to brown, and though not so large as most of the species of *Cattleya*, are nevertheless very beautiful.

OPERATIONS FOR MAY.

AURICULAS must be carefully preserved from slugs, caterpillars, &c., this month; and about the end, when they are quite out of flower, pot them. Those plants intended to produce seed instead of being potted, must be placed under a south wall, and have a good supply of water till the seed is ripe.

BIENNIALS raised on hotbeds should be planted in the open borders, or in pots, about the end of the month.

CACTÆ must now be watered carefully, and they will grow and flower well.

CAMELLIAS being now in a growing state, will require a temperature from sixty-five to seventy degrees by day, and from fifty-five to sixty degrees by night: if about the end they have perfected their shoots, immediately raise the heat to eighty or eighty-five degrees by day, and seventy or seventy-five degrees by night, to assist the formation of flower buds.

CARNATION. Seed should be shaken out of the capsule, and sown about the middle of the month in pans or pots of light soil, and the seed must be very lightly covered.

CHINA ROSES. Cuttings of the China Rose and its varieties may now be put in, and they will form fine plants soon.

CHRYSANTHEMUM INDICUM. Pot the best suckers in small sixty-sized pots, for flowering plants next season.

DAHLIAS in frames must be protected by mats against cold nights; those intended to be put out in the open air should be hardened by degrees: seed may now be sown in a slight hotbed, or a warm situation in the open air will suit.

ERICA cuttings continue to put in.

FRENCH AND ENGLISH ROSES, if desired to flower late, should now be pruned. Greenhouse plants may be exposed towards the end of the month if the weather prove congenial: all shifting should be completed before they are taken from the greenhouse.

HARDY ANNUALS continue to sow.

IPOMOPSIS ELEGANS should be planted in a cold damp soil, under either an eastern or western wall, about the end of the month, and others may be kept in pots to flower in the conservatory or greenhouse.

ORNAMENTAL PLANTS of every desirable kind should be propagated.

POLYANTHUSES should now be potted, and in other respects attended to.

TENDER ANNUALS, sown as directed last month, should be transplanted into light soil.





Poinsettia pulcherrima

L. Smith del.



THIS PAGE IS LOCKED TO FREE MEMBERS
Purchase full membership to immediately unlock this page



Never be without a book!

Forgotten Books Full Membership gives universal access to 797,885 books from our apps and website, across all your devices: tablet, phone, e-reader, laptop and desktop computer

A library in your pocket for \$8.99/month

Continue

*Fair usage policy applies

POINSETTIA PULCHERRIMA.

(SHOWY POINSETTIA.)

CLASS.
MONŒCIA.ORDER.
MONANDRIA.NATURAL ORDER.
EUPHORBIACEÆ.

GENERIC CHARACTER.—*Involucrum*, four-pieced. *Flowers*, partially stalked, naked. *Male flowers* in two parts, one-stamened. *Female flowers* solitary. *Germs* three-lobed. *Ovulum* solitary, with single lobes.

SPECIFIC CHARACTER.—*Shrub* erect, ramous; branches round, young shoots bluntly four-angled, green, glabrous, hollow. *Leaves* scattered, occasionally opposite, spreading, petiolate, ovato-elliptical, subacute, sinuated, veined, soft and pubescent on both sides, bright green above, paler below. *Petioles* furrowed above. *Bractææ* similar in shape to the leaves, but aggregated at the extremities of the branches, and splendid vermilion colour, paler below. *Cymes* terminal, subtrifid, at length falling off at a joint in the common footstalk. *Involucres* on short stout footstalks, articulated at the base, green ovato-orbicular, toothed, marked by five sutures on the outside; with which, alternate on the inside, five falcate processes, beginning with the narrow extremities at the mouth of the involucre, and, adhering to this with their backs, becoming gradually broader below, passing inwards, and attached to an elevation in the centre, they divide the lower part of the involucre into five distinct cells, and supporting on their edges erect fimbriæ, they divide the upper part also, but less completely. *Teeth* of the involucre numerous, coloured like the bractææ, woolly on the inside, connivent. *Appendage* single, on the outside of the involucre towards the axis of the cyme, round, entire, peltate, folded in the middle so as to appear two-lipped, nectariferous; four yellow teeth placed round the mouth of the involucre are abortive appendages. *Male flowers* about fourteen, in two rows in each loculament, and rising from its base, erect, petiolate, naked, monandrous, mixed with chaffs (abortive male flowers?) which are woolly at the apex, and occasionally tinged red there. *Petioles* colourless, as long as the involucre. *Filament* red. *Anthers* two-lobed, lobes divaricated, so that those which are next each other in the two rows overlap, opening at a deep furrow along their outside. *Pollen granules* yellow, lenticular. *Female flowers* solitary, central, on a short stout pedicle, naked. *Germs* three-lobed, each lobe emarginate; style wanting (?), ovule solitary in each lobe. These appearances I describe as I saw them, but the female flowers were probably imperfect, none enlarged, projected beyond the involucre, nor produced seed; but, after a while, a small number of the male flowers having been perfected, and protruded beyond their involucre, this became yellow, and separated at the articulation, near the base of the footstalk, the bractææ for some time remaining, and then the whole cyme dropped at the articulation in the common peduncle.—*Bot. Mag. t. 3493.*

SYNONYMS.—*Euphorbia pulcherrima*, Willdenow's *Herb.* *E. Poinsettiana*, Buist *MS.*

Fig. 1. Involucre; *2.* A section of the involucre exhibiting the five cells; *3.* Male flower showing its scale; *4.* A magnified abortive female flower.

THIS truly beautiful and very desirable stove plant, was introduced into Britain by Mr. James M'Nab, of the Royal Botanic Garden, Edinburgh, who brought plants of it to that and other establishments in Scotland, in 1834, from Mr. Buist, of Philadelphia. In 1828 it was sent to Charleston, by Mr. Poinsette, who discovered it in Mexico, whence it was received by Mr. Buist, through whose liberality and kindness many collections in England have been favoured with this valuable addition.

The character of the plant is that of an erect luxuriant shrub, five or six feet

high, with comparatively few branches and leaves; the extremity of each branch is surmounted by the flower envelopes, or *bracteæ*; these, which are disposed in irregular whorls, are of an exquisite rich scarlet colour, nearly equal in brilliancy to *Verbena chamædrifolia*. In the stove nothing can exceed the ornamental effect they create; and, in consequence of the flowers remaining perfect a considerable time, together with the fact of their being produced in the autumn, they are conspicuously exhibited through a great part of winter.

It grows well in a hot stove, potted in good open, rather sandy loam, mixed with a little reduced dung or vegetable mould, and in order to keep it in a clean free-growing state, it requires plenty of water at the roots, and frequently to be carefully syringed all over the leaves and branches; this will encourage the latter to swell, and the former to develop, the result of which will be large, healthy, high coloured *bracteæ* at the termination of every branch, approaching in magnitude and colour those grown at Philadelphia, which measured as much as twenty inches across, and equalled in colour the finest tints of *Hibiscus Rosea sinensis*. In spring, before the plant is potted, or the buds begin to push, the branches of the



previous year should be cut down to within three or four eyes of the old wood. After this, the wounded parts must be kept dry for a few days, in order to dry up the sap which always flows most copiously if the least fracture takes place; the portions taken off, made into cuttings, strike with ease in a pot of sand, or sand and loam mixed, if placed in a gentle bottom heat with a glass over them; but before the cuttings are planted in the soil, it is advisable to lay them for a day or two in an airy part of the house, for the purpose of drying up the sap, which will favour their striking.

Our drawing was made from a plant which flowered in the stove at Chatsworth last autumn, for the character of which, see above figure.

The generic name is given in compliment to Mr. Poinsette, who discovered the plant in Mexico in 1828.



THIS PAGE IS LOCKED TO FREE MEMBERS

Purchase full membership to immediately unlock this page

DELVE INTO FANTASY, MAGIC, MYTHOLOGY & FOLKLORE

Forgotten Books'
Full Membership gives
access to 797,885 ancient
and modern, fiction and
non-fiction books.

Continue

*Fair usage policy applies



Miss Worrish del. - Smith sc.

Dillwynia glycinifolia

JUN

SECRET

CONFIDENTIAL

CONFIDENTIAL

SECRET



THIS PAGE IS LOCKED TO FREE MEMBERS
Purchase full membership to immediately unlock this page



Never be without a book!

Forgotten Books Full Membership gives universal access to 797,885 books from our apps and website, across all your devices: tablet, phone, e-reader, laptop and desktop computer

A library in your pocket for \$8.99/month

Continue

*Fair usage policy applies

of peat should never be employed to less than two parts of loam, and if both peat and loam contain a good portion of sand in themselves, little besides need be added. In some instances it is not necessary to use loam in the composition at all, and it now and then happens that less peat than loam is required; but whether the proportions are necessarily equal or unequal, it is always best to incorporate such a quantity of sand as will be sufficient to keep the whole from binding or setting in the pot. In potting, it is essential to pack the soil close down by the side of the old bale, by pressing it with the hand or potting stick, for if suffered to remain hollow or slack, the roots do not thrive. The pots should be always well drained at the bottom, in order to let the water pass freely. Water should not be administered when the soil appears full of moisture, or when it feels in the least soddened, especially during winter. Cuttings taken from our present subject, root freely in a pot of sand, with a glass placed over them.

Dillwynia glycinifolia is greatly and justly admired by all lovers of New Holland plants, and certainly there is not one that has greater claims, or produces a more charming effect, when in flower in the greenhouse or conservatory, with its slender branches, and linear ovate brownish green leaves, and profuse number of pretty blossoms. A fine grown specimen flowered richly in Messrs. Lucombe, Pince, and Co.'s conservatory, Exeter, in February last, from which the accompanying drawing representing a portion of it, was made by Miss Morrish, a young lady of that city, whose qualifications in the art of drawing flowering plants we have had frequent occasion to notice, as may be seen by referring to our pages.

The generic name is given in honour of Lewis Weston Dillwyn, F.R.S. F.L.S., &c., whose labours upon different parts of British Botany, particularly the Confervæ, are well known.



Leucothoe floribunda

n. Arn. Smith sc.

JUNE 1837



THIS PAGE IS LOCKED TO FREE MEMBERS

Purchase full membership to immediately unlock this page

DELVE INTO FANTASY, MAGIC, MYTHOLOGY & FOLKLORE

Forgotten Books'
Full Membership gives
access to 797,885 ancient
and modern, fiction and
non-fiction books.

Continue

*Fair usage policy applies

LEUCOTHOE FLORIBUNDA.

(BUNDLE-FLOWERED LEUCOTHOE.)

CLASS.

DECANDRIA.

ORDER.

MONOGYNIA.

NATURAL ORDER.

ERICACEÆ.

GENERIC CHARACTER.—*Calyx* five-leaved; leaves imbricated at the base. *Corolla* tubular, five-toothed. *Stamens* inclosed, filaments dilated, flattened, downy; cells of anthers short, truncate; mutic (pointless). *Stigma* ample, capitate. *Capsule* with a loculicidal dehiscence.

SPECIFIC CHARACTER.—*Plant*, a hardy evergreen shrub, two feet high, quite glabrous. *Leaves* ovate, oblong, finely serrulated, adpressedly ciliated, glabrous, coriaceous. *Racemes* secund, axillary, and terminal, forming panicles. *Pedicles* bibracteate.—D. DON.

SYNONYME.—*Andromeda floribunda*.—*Bot. Mag.* 1566.—*Bot. Reg.* 807.

THIS very showy and ornamental plant is a native of the mountains of Georgia in North America, where it grows to a large and very handsome shrub, and is covered with a profusion of its pure white flowers early in the spring. In this country the flowers, which literally cover the plant, are formed in the autumn, and remain unopened until the ensuing spring, when about March or April they begin to expand, and assume that exquisite whiteness which forms so striking and beautiful a contrast with its own and other surrounding foliage; and in this state the flowers continue in perfection for upwards of six weeks. It was introduced by Mr. Lyons in 1811.

Though considered quite hardy, it has been at Chatsworth treated in the greenhouse, where, in consequence of the flowers existing in an unopened state through the winter, it appears to us as the only place in which they are likely to be brought to perfection. If planted out in the open air, a situation where cold cutting winds are guarded off should be preferred for it, which will no doubt materially tend to preserve the young flowers from injury until the warmth of March and April induces the blossoms to expand in all their beauty and elegance, a thing so very desirable at that season. It grows best in sandy peat soil, and seems to require a liberal supply of water. After the flowers fade, the young shoots begin to push in

abundance, when it must not on any account be stinted of water—that is to say, if it is grown in a pot; but if planted in a border in the open air, that element of course will be naturally supplied at that season; still, if the summer prove very hot, the soil may require watering, which should be immediately attended to. It may be increased, though with some difficulty, either by layers or by seeds. It is best to sow the seed in sandy peat soil, in pots or pans slightly covered over with earth, as they are extremely small.

The drawing was made from a plant which flowered profusely in the greenhouse at Chatsworth this spring.

We regret that this valuable species is not more general in collections: this is most likely owing to its being rather difficult to increase; however, it may in all probability be procured, at a reasonable cost, in any of the principal nurseries about London.



THIS PAGE IS LOCKED TO FREE MEMBERS
Purchase full membership to immediately unlock this page



Never be without a book!

Forgotten Books Full Membership gives universal access to 797,885 books from our apps and website, across all your devices: tablet, phone, e-reader, laptop and desktop computer

A library in your pocket for \$8.99/month

Continue

*Fair usage policy applies

dominions, and the Dutch were, in consequence, often restricted to less than half their required annual exports.

Governor Falk, in his attempt to remedy this evil, by cultivating the cinnamon-tree in the territory belonging to the Dutch, was discouraged by the prejudices of the natives, and discountenanced by the parsimony of the Supreme Government of Batavia.

It was said, "For one hundred and fifty years Ceylon had supplied the requisite quantity of cinnamon, the expense of which was ascertained and limited: why then risk the success of a new plan, attended with extraordinary charges." This public-spirited governor nevertheless persevered in his undertaking, and to his success the English owe the flourishing state in which they found the cinnamon plantations of Ceylon, when they captured that island. This tree is now cultivated in four or five very large gardens, the extent of which may, in some measure, be imagined by the quantity of cinnamon annually exported thence, amounting to more than 400,000 lbs.; and from the number of people who are employed in the cinnamon department, these being from twenty-five to twenty-six thousand persons.

The trade in this produce had always been a monopoly; during the government of the Dutch this was enforced with an excessive degree of rigour, at which humanity revolts. It is painful to contemplate man, when greediness for exclusive gains, the meanest of all motives, incites him to acts of oppression and tyranny.

The selling or giving away the smallest quantity of cinnamon (even were it but a single stick), the exporting of it, the peeling of the bark, extracting the oil either from that or the leaves, or the camphor from the roots, except by the servants of government, and by their order, as well as the wilful injuring of a cinnamon-plant, were all made crimes punishable with death, both on the persons committing them and upon every servant of government who should connive at it.

In order to keep up the price of the spices, the Dutch government was formerly accustomed to have these destroyed, when supposed to be accumulated in too large quantities. Sometimes, it was said, this oriental produce was thrown into the sea, and sometimes the work of destruction was accomplished by other means. M. Beaumare relates, that on the tenth of June, 1760, he beheld, near the Admiralty at Amsterdam, a blazing pile of these aromatics, which were valued at eight millions of livres, and an equal quantity was to be burnt on the ensuing day. The air was perfumed with this incense; the essential oils, freed from their confinement, distilled over, mixing in one spicy stream, which flowed at the feet of the spectators; but no person was suffered to collect any of this, nor on pain of heavy punishment to rescue the smallest quantity of the spice from the wasting element!

When in its natural state, the cinnamon tree attains to the height of twenty or thirty feet, sending forth large spreading branches clothed with thick foliage. The leaf when first developed, is partly of a bright red, and partly of a pale yellow; it soon, however, assumes a verdant hue, and when at its full growth is on the upper surface of a dark olive colour, and on the under side of a lighter green; it somewhat resembles that of the bay, but is longer and narrower. The flowers bloom in January; they grow on footstalks, rising from the axilla of the leaves, and the

extremities of the branches, clustering in bunches, which resemble in size and shape those of the lilac, but they are white with a brownish tinge in the centre; these are followed by one-seeded berries of the shape of an acorn, but not so large as a common pea. When first gathered their taste resembles that of a juniper berry. When dry, this fruit becomes merely a thin shell, containing a kernel about the size of an apple seed. The smell of the flowers, though not powerful, is extremely fragrant. The footstalks of the leaves have a strong flavour of cinnamon. The fruit, if boiled, yields an oil, which, when cold, becomes a solid substance like wax, and is formed into candles; these emit an agreeable odour, and in the kingdom of Candy are reserved for the sole use of the Court.

The trees which are cultivated are kept as a sort of coppice, and numerous shoots spring apparently from the roots; these are not allowed to rise higher than ten feet. We are told, that "when the trees first put forth their flame-coloured leaves and delicate blossoms, the scenery is exquisitely beautiful." In three years after planting, each tree affords one shoot fit for cutting, at the fifth year from three to five shoots may be taken, but it requires the vigour of ten years' growth before it yields as many as ten branches of an inch in thickness. From the ages of ten to twelve years is the period of its greatest perfection; but its duration of life is not limited, as the root spreads, and every year sends up new shoots or suckers.

Trees which grow in rocky situations, and the young shoots, when the leaves are of a reddish colour, yield the best and most pungent aromatic bark. The tree is known to be in the best state when the bark separates easily from the wood, and has the inside covered with a mucilaginous juice; but if that be not carefully removed, the flavour of the spice is injured. The shoots are cut when from half to three quarters of an inch in thickness, and in lengths of from two to three feet. Many hands are employed in this work; each man is obliged to furnish a certain quantity of sticks. When this part of his task is fulfilled, he conveys his fragrant load to a shed allotted for the purpose, where the bark is instantly stripped from the wood and freed from the epidermis, which is scraped off.

The fragrance diffused around during this process, is described as being extremely delightful, but in parts of the plantation remote from this spot, unless the trees be agitated with violence, the peculiar smell of the cinnamon cannot be distinguished. The wood deprived of the bark has no smell, and is used as fuel.

When the bark is perfectly cleansed it is of a pale yellow colour, and about the thickness of parchment. It is then placed on mats to dry in the sun, when it curls up, and acquires a darker tint. The smaller pieces are then put inside the larger, and the whole close together in the tubular form in which it is sold in the shops. When the rind, or part forming the cinnamon, is first taken from the tree, it is described as consisting of an outer portion which tastes like common bark, and an inner portion, which is very sweet and aromatic. In the course of the drying, the oil of the inner portion on which the flavour depends, is communicated to the whole, and the quality of the entire bark is understood to depend more upon the relative quantities of those portions of the bark than upon anything else. The cinnamon of

Ceylon has the outer portion much thinner, in proportion to the inner, than the cassia of other countries; and to that its higher pungency is attributed.

Under favourable circumstances, the cinnamon-tree yields a large and a small harvest every year. The large one is obtained soon after the fruit is ripe; that is, when the tree has again pushed out shoots, and the sap is in vigorous circulation. May and June are the best months in the year for the great harvest; in November and December the little harvest is obtained. In those plantations which belong to government, however, there is but one harvest, beginning in May and ending in October.

Though cinnamon has found a place in our Pharmacopœia, the purpose to which it has been applied by the South Americans invests it with medicinal properties which it is not usually supposed to possess. "One thousand bales (92,000 lbs.) are said to be consumed annually by the slaves in the mines of South America. Each receives daily a certain quantity, cut into pieces one inch in length, which he eats as a preservative against the noxious effluvia of the mines."

Oil of cinnamon was formerly obtained at Colombo, from distilling the fragments broken off in packing; latterly a great proportion has been made from coarse cinnamon unfit for exportation. A very small quantity of oil is contained in the bark; three hundred pounds of which are required to yield twenty-four ounces of oil, and, consequently, this is extravagantly dear. When made from the finest cinnamon its specific gravity is greater, but from the coarse sort it is less, than that of water.

CULTURE OF THE RABBIT-BERRY.

(SHEPHERDIA ARGENTEA.)

THIS shrub is a native of North America, whence it has been lately introduced; it forms a slender but neat shrub, and bears a profusion of good palatable fruit, which are as good, if not better, than our best red currants. In the collections of plants in this country it grows very slowly, and rarely produces fruit, and what it does produce is of a very inferior quality.

This deficiency probably arises from two causes; first, because our summers are scarcely hot enough for its growth, and, secondly, because the soil in which it is usually planted is scarcely such as suits it. The soil of the vast plains on the banks of the Missouri, where the plant grows spontaneously, is rich and very light; perhaps the nearest resemblance we can have to it is, a mixture of very rotten leaf soil and sandy heath mould: this therefore is the soil which seems to suit it best.

If planted in the open air of this country, it requires a very warm situation, either a south-east wall, the front or end of a hothouse, or a very sheltered border where it will be affected by no cutting winds. Wherever it is planted it must not be fully exposed to the mid-day sun, or be allowed to suffer from drought, and there is then every probability of the best success.

If grown in pots the following mode of treatment may be adopted:—Pot the



THIS PAGE IS LOCKED TO FREE MEMBERS

Purchase full membership to immediately unlock this page

DELVE INTO FANTASY, MAGIC, MYTHOLOGY & FOLKLORE

Forgotten Books'
Full Membership gives
access to 797,885 ancient
and modern, fiction and
non-fiction books.

Continue

*Fair usage policy applies

cultivated, are nevertheless so easy to preserve, and render a small pond so attractive at the season of flowering, that we have added a short list and a few brief hints, in the hopes that they may stimulate to the more extensive culture of these curiosities of nature.

Plants that grow in water are not all true aquatics, but may be divided into two kinds—first, such as are constantly immersed and exist in water; and, secondly, such as grow in wet bogs, or morasses, where at different seasons they become partially or wholly dry.

All true aquatics necessarily divide themselves into three kinds, according to the temperature required for their successful culture; namely, such only as will grow in the stove, such as will thrive in the greenhouse, and those that will bear the open air, called hardy—as follows:—

STOVE AQUATICS.

Euryale ferox.	Nymphæa edulis.
Limnocharis Humboldtii.	Pontederia azuerea.
— Plumierii.	— dilatata.
Nelumbium speciosum.	— crassipes.
— — album.	— lanceolata.
— Jamaicense.	Thalia dealbata.
— luteum.	Damasonium Indicum.
Nymphæa Lotus.	Villarsia Indica.
— cærulea.	Papyrus antiquorum.
— rubra.	— odoratus.
— blanda.	— elegans.
— stellata.	

GREENHOUSE AQUATICS.

Damasonium ovalifolium.	Heteranthera reniformis.
Sagittaria sinensis.	— acuta.
— obtusifolia.	Jussieua grandiflora.
— acutifolia.	— natans.
— angustifolia.	— suffruticosa.

HARDY AQUATICS.

Nymphæa odorata.	Heteranthera limosa.
— alba.	Villarsia cordata.
— — Canadensis.	Menyanthes Americanus.
— nitida.	Butomus umbellatus.
Nuphar lutea.	— latifolius.
— Kalmiana.	Sagittaria latifolia.
— sagittæfolia.	Stratiotes aloides.

BOG OR MARSH PLANTS.

Nepenthes distillatoria.	Drosera Americana.
— phillamorpha.	— acaulis.
Cephalotus follicularis.	— linearis.
Dionæa muscipula.	Byblis liniflora.
Drosera binata.	Aldrovanda vesiculosa.
— pauciflora.	Eriocaulon septangulare.

It must not be understood from the above selection, that we confine the cultivator to grow them in the situations specified, for although the stove species

will not grow in any other temperature, yet the kinds marked for the greenhouse will thrive well in the stove, and the hardy ones in the greenhouse; the situations however we have marked for them we consider the best for their success. Although we shall defer entering at large upon the subject of forming fountains and ponds for aquatic plants to another opportunity, yet a few hints here may not be without their use.

1. All fountains, ponds, or cisterns made in stoves, conservatories, or greenhouses, should be either lined with sheet lead or Roman cement; the first answers the best, because the latter is likely to be broken by taking out water for the various purposes of the house; but fountains, &c. in the open air may be rendered secure by clay, if it is not convenient to go to the expense of lead or cement.

2. All fountains and cisterns require a reservoir to supply them by means of leaden pipes, but a pond may be supplied by common under-ground drains, made of stones or any other convenient material.

3. The reservoir intending to produce a jet, must be situate on a sufficient elevation to play the intended fountain, and not at too great a distance—for two reasons; first, because the expense of piping would be great, and the pipes are liable to burst from the great pressure; and, secondly, because the shorter the distance, the less power will be lost by friction, and the more lively the jet will play.

4. Water may generally be calculated to lose from six to nine inches of power in every hundred yards of pipe, from friction, inclination, and interruptions; so that if a reservoir be situated two hundred yards from the fountain it supplies, and be on ground twenty feet higher, the jet will be from eighteen feet six inches to nineteen feet high, according to the bore of the pipe and other local circumstances.

5. If the reservoir be not very far distant, the pipes should be of an uniform bore, always four times as large as the jet they are intended to produce; thus, if the pipe be two inches bore, the perforation through which the jet passes must not exceed half an inch. But if the reservoir be situated at several hundred yards distant from the fountain, the upper half of the pipe may be an inch wider in the bore than the lower half which communicates with the fountain; this gives a greater liveliness to the water at the end: also air pipes are necessary; but as the subject will probably ere long be treated of at length, we shall say no more on it at the present time, but proceed to the culture of the various plants mentioned above.

GENERAL OBSERVATIONS ON THE CULTURE.

1. *Propagation.*—All the above-mentioned aquatics are perennial herbaceous plants, and may for the most part be increased by division of the roots, and, when that cannot be accomplished, by seeds.

2. The seeds should, if possible, be sown immediately after being gathered, as in general they soon lose their vitality, although those of the *Nelumbium* are an exception, continuing good for many years.

3. Sow the seeds in small pots in a very light rich mould, as rotten leaves, &c.; and place them in a shallow pot of water in a cucumber frame, or other brisk heat; and when the plants come up, plant them singly into sixty-sized pots and replace them in the water; shift them as they advance in growth, and place them every time into a deeper vessel of water, and when large enough plant them in the aquarium they are intended to occupy.

4. Division of the roots should always take place when the plants are in a torpid state, and a short time before they commence growing; pot them at first, and treat them like seedlings, until large enough to plant in the aquarium.

5. The best soil for the general culture of these plants is a mixture of equal parts of very rotten leaf-mould, and rich mellow loam. For strong growing plants this must be placed at the bottom of the aquarium, but all delicate plants will do better in pots filled with it, which may be either suspended by hooks in the water or placed on steps in the pond.

6. When the basin is full of water, and it is desired to insert another plant at the bottom, the best way is to fix the plant with soil in a small open basket of wicker-work, and let it down by means of a hook to its appointed station, giving the basket a slight press to insert it in the mud; the roots will soon find their way through, and spread in the soil at the bottom.

The stove species of all these genera grow with more freedom in a very damp and close heat, particularly in that of a hotbed. Some of them are very beautiful, particularly the species of *Nymphæa*, nearly all of which are very scarce.

All the *Nymphæas* grow delightfully in small pots (sixties), which may be either set in large pots of water, with the hole at the bottom plugged up, or in little troughs of wood.

The water in pots or troughs should be changed twice or three times a week during the season of growth, but in winter once a week will be sufficient. Never allow confervæ to increase on the surface of the water, for it will inevitably injure the health of the plant.

The usual time of their wintering is from October to March; they should then be-repotted and replaced in the water, at first to a little depth—and as the plants grow, sunk deeper.

If all the stove aquatics are planted in a pond, no further care is required than a supply of fresh water at stated periods, so let in as not to chill the plants and check their growth.

PROPAGATION.—*Nymphæas* produce runners from their roots in May, which are separated and planted in sixty-sized pots.

Euryale does not propagate from the roots as *Nymphæas*, but produces seeds very freely if the pollen be laid on the stigma with a camel-hair pencil. These seeds should be sown in small pots, and placed in water in January. All the other aquatics are easily propagated by division of the roots.



THIS PAGE IS LOCKED TO FREE MEMBERS
Purchase full membership to immediately unlock this page



Never be without a book!

Forgotten Books Full Membership gives universal access to 797,885 books from our apps and website, across all your devices: tablet, phone, e-reader, laptop and desktop computer

A library in your pocket for \$8.99/month

Continue

*Fair usage policy applies

lastly, seeds; for although seedlings make fine plants, they are liable to deteriorate and become little worth, or, if good, they are several years before they arrive at a fruit-bearing state.

For stocks, we recommend the common Whitethorn (*Cratægus oxyacanthæ*), although the medlar, quince, mountain-ash, service, and many other hardy kinds answer very well; whichever stocks are used, grafting must be performed when these stocks are not in a vigorous state of growth, and also before the Loquat begins to grow; about the end of October answers remarkably well, if the plants from which the scions be taken are retarded a little for the purpose. If the Loquat be growing out of doors grafting may readily be performed in February at the usual grafting season. For the different mode of grafting, see Vol I. page 93.

When the scions are fixed and tied secure, a little moss may be tied about them, and over this a small quantity of clay. When grafted, plunge the pots of stocks in a brisk hotbed where they will have a very moist heat, and in half the usual time the grafts will have grown, and may be unloosed, and the following season the plants will flower and bear fruit.

6. *Soil.* The most proper soil for the plant in its fruiting state is a light rich loam, from the upper surface of a pasture where sheep are fed; mix this with one-fourth very rotten horse-dung and one-fourth leaf-mould. These should be well mixed and broken together, and exposed to the influence of the sun some time before being used. But for young plants newly struck, or seedlings, one-fourth more leaf-mould must be added.

7. *Potting.* The only proper time for potting a fruiting plant is early in October, just before the season for starting into growth; for if performed at any other time, a check will be given which might either prevent the fruit setting, or cause it to fall after being set; and indeed it sometimes entirely prevents it from flowering.

In potting in October be very careful not to break the ball of earth too much, and damage the tender fibres as little as possible; take off, however, from both the bottom, top, and sides, a little of the old earth, insert in a larger pot where it will have plenty of room, and afterwards set it in the stove. When by this mode the pots become too large and unsightly, which will be the case in about four years, take out the plants at the usual potting season, lessen the balls, and place them again in small pots, thus giving them a year's rest from fruiting; if one or two be treated thus every season, the plants will always appear fresh and young.

8. *Wintering.* The usual season of this plant flowering in the stove is the end of December or beginning of January, the fruit ripens in April, and the wood becomes pretty hard by the middle of June; this gives a clue to the most proper time for wintering, which should be from the end of June to the middle or end of October; *never later.* During the season of hybernation, plunge the pots up to the rim under a north wall, where the plants will receive little or no sun and heat; water, if they require it, which will be seldom, if not exposed to the sun.

9. *Pruning.* The chief design in pruning is to get as much young wood as possible, the flowers being produced from the extremities of the young shoots.

Never shorten any shoot unless it be necessary to do so for the beauty of the plant, because the shoots starting from the extremities are almost sure to produce abundance of blossoms.

10: *Forcing*. From the middle to the end of October is the proper time to bring the plants into the stove. Set them in a cool part of the house for a few days, that the change may not be too violent; for if this be not attended to, the wood is liable to be affected and become blotched, and this is sure to lead to a weakly growth and paucity of flowers. After a few days plunge the pots up to the rim in the bark pit, and in a week they will show signs of vigorous growth.

11. *Watering*. During the early part of their growth, water the plants sparingly, but as they increase in growth give them a greater quantity, and when in flower they require a good supply. After the fruit is set, water occasionally overhead, and about once a week give a supply of manure water to the roots, particularly pigeons' manure.

12. *Top-dressing*. After the plants have flowered, and the fruit are set, take off a little of the old soil, and top-dress with the before mentioned compost, adding a little fresh pigeons' dung. Also, after the fruit are gathered top-dress, again to encourage the latter growth before wintering.

13. *Blossoming*. When the plants are in flower they require more air than usual to promote the setting of the fruit, but care must be taken not to allow a direct cold draught, or the design of the air would be defeated.

14. *Fruiting*. After the fruit are set give a strong heat, and water freely, and by the middle of March the fruit will be full grown, about the size of a large gooseberry.

When the fruit is full grown, and begins to ripen, discontinue watering over the head, water rather less at the roots, and give a little more air; and by the middle of April, if the weather is favourable, the fruit will be ripe and of an excellent flavour.

When the wood is ripe, in June turn the plants out of doors to winter them as before directed.

ON THE CULTURE OF THE ROUGH-LEAVED DEUTZIA.

(DEUTZIA SCABRA.)

THIS is a new hardy shrub of a most beautiful character. It belongs to the Linnæan Class and Order *Icosandria Monogynia*, and the Natural Order *Philadelphææ*. In April it is literally clothed with a profusion of delicate white flowers hanging in terminal racemes, greatly resembling, but far more copious and lovely than, those of the common syringa, but without fragrance. When the plant is large and in full bloom, its beauty can scarcely be conceived by any but observers.

It is a native of Japan, where it is found growing plentifully in the neighbourhood of the Fakon Mountains, forming a dense bush ten or twelve feet high. It was introduced by John Reeves, Esq., in 1833, and from its easy culture and propagation it may now be obtained in almost every nursery in Britain.

It grows very freely in any light rich mould, particularly in a mixture of very rotten leaves and sandy heath mould.

This plant also makes a very beautiful conservatory plant whilst small, being readily brought into flower any time in the winter, by placing it for a short time in the stove.

It increases most readily by cuttings of the half-ripened wood, planted in leaf mould and placed in a cucumber frame, or under a handglass on a warm border out of doors.

ON THE CULTIVATION OF THE GENUS CAMELLIA,

AS PRACTISED BY MESSRS. CHANDLER, VAUXHALL.

As it is more than probable that many of our readers have never seen Messrs. Chandler's collection of Camellias, and as they have long stood among the first in the list of cultivators of this beautiful genus, we have taken this opportunity of laying before our readers a short notice of the system pursued by them, which is attended with the greatest possible success.

The first thing to be noticed is the system of propagation, and as this is carried on rather extensively by Messrs. Chandler, they have small brick pits made for the purpose; these are from four to five feet wide, and are carried out to any required length; they are covered with lights four feet wide, and under the centre of each light is placed a quantity of soil prepared for the purpose, which is a mixture of loam and peat, and this is put a sufficient distance from the glass to admit of a good sized plant being placed in it: this done, plants of every species or variety which is desired to be propagated, are here planted out, one under each light; these are duly attended to till they are sufficiently well established to be capable of producing grafts, and a quantity of young stocks in pots are then introduced round each of the plants; these are placed (on coal ashes) at intervals wherever there is a shoot in a proper state for inarching, and the young shoots are then inarched on to the said stocks; they are then secured, by shading, from the direct and powerful rays of the sun, until they become so firmly united to each other that the shoots may be carefully cut off the parent plant without sustaining any injury; the plants from which these shoots have been taken, though necessarily very much weakened for the time by being thus cut in, will not suffer materially from it, but, on the contrary, will in due time re-produce a greater abundance of young wood than before, and will bear to be submitted again and again to the same mode of treatment. While the old plants are thus suffered to remain in the same situation, the young stocks thus grafted upon are removed into the greenhouse, where they are treated in a similar manner to the old ones. According to the same treatment, others are propagated by layers, the plants being planted out as before named, and the young shoots laid down into pots, which are introduced round the plant; either of these methods answers very well, but it appears that the latter is best adapted for the more common species and varieties, while the rare and choice ones are propagated with greater success by inarching.

Messrs. Chandler pot their Camellias about the month of September; the soil



THIS PAGE IS LOCKED TO FREE MEMBERS

Purchase full membership to immediately unlock this page

DELVE INTO FANTASY, MAGIC, MYTHOLOGY & FOLKLORE

Forgotten Books'
Full Membership gives
access to 797,885 ancient
and modern, fiction and
non-fiction books.

Continue

*Fair usage policy applies

afraid that our damp summers will prevent its ripening seed with any certainty. —*Bot. Reg.* 1954.

THE RANUNCULUS TRIBE (RANUNCULACEÆ).

CLEMATIS CÆRULEA. Violet Clematis. This is a beautiful addition to the hardy climbers cultivated in England; it is a very graceful growing plant, and produces large violet flowers, with deep purple stamens, which are more ornamental than those of any species of Clematis yet in this country. Dr. Lindley states it to be nearly related to *C. florida*, but from which it differs in the colour, delicacy, and transparency of its blossoms, as also in its leaves being only one ternate, and in the sepals not touching and overlapping each other at the edges. The drawing was made from Messrs. Lowe and Co.'s collection, Clapton, who informed Dr. Lindley, that it is a native of Japan, from which country it was introduced into Europe by Dr. Van Siebold. It was received at Clapton from Belgium, in the spring of 1836. It is a free growing and profuse blooming plant. *Bot. Reg.* 1955.

THE ROSE TRIBE (ROSACEÆ,) POMEÆ.

STRANVÆSIA GLAUDESCENS. Grey-leaved Stranvæsia. The first plant of this remarkable new evergreen was first brought to England by Dr. Wallich, about eleven years since, and placed in the garden of the Horticultural Society, under the name of *Cratægus glauca*. Its native country are the provinces of Nepal and Kamaon. In the neighbourhood of London it is scarcely more hardy than a common myrtle, but it grows very well against a wall when protected, and in such a situation produces its white flowers in June. Its leaves are something like those of *Photinia integrifolia*, but from which its serrated leaves will readily distinguish it. It takes by grafting or budding upon the common thorn, and may be procured without difficulty in the nurseries under the name of *Cratægus glauca*. —*Bot. Reg.* 1956.

THE HOUSE-LEEK TRIBE (CRASSULACEÆ).

ECHEVERIA RACEMOSA. Racemed Echeveria. This is a pretty species of the handsome genus Echeveria. The leaves are a brownish green colour, and glaucous hue, about three inches long, and the flowers scarlet yellow. The Glasgow garden received it from Claremont under the name here adopted. It is supposed to be a native of Mexico; it flowers freely in the greenhouse in the summer and autumn months. *Bot. Mag.* 3570.

THE WATERLEAF TRIBE (HYDROPHYLLACEÆ).

EUTOCA VISCOSA. Clammy Eutoca. This is a most lovely hardy annual bearing large brilliant deep blue flowers, pale and dotted in the centre; there is a constant succession of them during the fine weather. It is a native of California, whence it was introduced by Mr. Douglas. *Bot. Mag.* 3572.

GESNERACEÆ.

GESNERIA SCEPTRUM; var. IGNEA. Scepterum-flowered Gesneria, pale flowered variety. A pretty plant of this handsome and ornamental genus. The leaves are a vivid green, flowers orange coloured. It was introduced to the Glasgow Botanic Garden, by Mr. Murray, from Brazil. *Bot. Mag.* 3576.

CLASS II.—PLANTS WITH ONE COTYLEDON (MONOCOTYLEDONEÆ).

THE ORCHIS TRIBE (ORCHIDEÆ, VANDEÆ).

MAXILLARIA STEELII. Mr. Steele's Maxillaria. This is a highly interesting species of Maxillaria, with small oblong, brownish green pseudo-bulbs, from which arises a cylindrical leaf, about the thickness of a swan's quill, which suddenly bends almost at an angle, and hangs over the sides of the pot two or three feet; the blossom is a dingy reddish yellow, blotched with deep purple, and is rather large and fragrant. It flowered for the first time in the stove of John Moss, Esq. Otterspool, near Liverpool. It is a native of Demerara, and was introduced by Matthew Steele, Esq. *Bot. Mag.* 3573.

SARCANTHUS TERETIFOLIUS. Round-leaved Sarcanthus. This is a curious looking plant, a native of China, whence it was introduced into our stoves by Mr. Brookes, of Newington Green. The stem is green and jointed, sending forth thick, fibrous roots from the various parts of their joints, and a cylindrical leaf from the top of each about three inches long. Sepals spreading, dull green with reddish lines, lip white, having at the base two lobes edged with red. *Bot. Mag.*, 3571.

PERISTERIA CERINA. Waxen Dove-flower. This is a new species imported from the Spanish Main, by Mr. Knight, of the King's Road, in whose collection it flowered in June last. It is allied to *P. pendula*, from which it differs in its spotless smaller flowers, and especially in the absence of wings from the column. The flowers are dull yellow, having a strong smell of juniper. *Bot. Reg.* 1953.

MALAXIDEÆ.

MEGACLINIUM MAXIMUM. Largest Megacelinium. This is a curious species of a most singular genus of plants, with pale green flowers, blotched with red. In general appearance, it is like *M. falcatum*, from which species it appears to differ, in having larger leaves, less deeply notched at the point, and more revolute at the edges; its lip is hardly so moveable as in *M. falcatum*. Dr. Lindley thinks it will prove one of the easier kinds to cultivate. It was introduced from Sierra Leone, by the Messrs. Loddiges, in whose collection it flowered in August last. —*Bot. Reg.* 1958.

ERRATUM.

THE BRUGMANSIA SUAVEOLENS, noticed at page 87 of our last month's number, is there stated to have been planted by, and to be the property of, C. L. Spong, Esq. We have received a letter from Mr. Spong disclaiming such honour, and stating that he is the gardener, &c., to R. Gordon, Esq., M.P., at Leweston, near Sherborne, Dorsetshire, in whose conservatory it was planted by him ten or eleven years ago. Our error was indeed quite unintentional.

NOTICES OF NEW AND RARE PLANTS

IN FLOWER IN THE PRINCIPAL NURSERIES AND PRIVATE GARDENS IN
THE VICINITY OF LONDON.

MESSRS. HENDERSON'S, Pine-Apple Place. *Verbena Tweediana*. This lovely little plant, which is without exception the best known species of this genus, is now exhibiting its dazzling crimson-coloured blossoms in great perfection in the greenhouse of the above nursery; it is certainly a most valuable addition to the already numerous and beautiful species which constitute this genus, and, on account of the superiority of its flowers to all other known species, not excepting even *V. chamædrifolia*, no collection, however limited, should be destitute of it. Messrs. Henderson, and most of the London nurserymen, as well as Mr. Young, Epsom, possess a good stock of it. Perhaps the best accession lately made to our present stock of early flowering greenhouse plants is in Messrs. Henderson's seedling *Cinerarias*, which are indeed truly splendid; their dwarf habits, free mode of flowering, and the brilliancy of the colour of their flowers, pronounce them at once to be far superior to any thing of the kind before known, and justly entitle them to a place in any, or every collection. *Cytisus racemosus*. This is a new and very beautiful species of this extensive genus; the flowers, which are yellow, are produced at the extremities of the branches in dense racemes, and when in flower (which it now is at the above nursery) it has a very pretty appearance.

MR. KNIGHT'S, Chelsea. *Azalea littorea*. This is another of Mr. Knight's beautiful *Azaleas*, and is now, together with many other species and varieties of this beautiful genus, flowering in great profusion. In the orchideæ-house the *Acanthophippium bicolor*, a somewhat rare orchideous plant, is now beautifully in flower; as well as one or two fine varieties of *Oncidium papilio*, which are far superior to the original species.

MESSRS. LODDIGES', Hackney. *Aerides odorata*. This charming plant, which may with propriety be termed "the loveliest of all lovely plants," and which is, without exception, the most delightful feature in that peculiarly interesting family Orchideæ, perhaps was never before seen to flower in such profusion and perfection as it is now doing in the collection of Messrs. Loddiges; a fine grown and remarkably large specimen in the above named collection is now producing no less than between twenty and thirty fine racemes of flowers; these last being of a very delicate colour, and fragrant to so great a degree, as almost to become proverbial, added to the elegant and curious habit of the plant, render it one of the finest ornaments at present known to our collections; and, accustomed as we are to see and admire the beautiful and varied forms in which the flowers of orchideous plants develop themselves, we at once confess that we never before witnessed such an interesting and lovely object as that which we are now noticing; and surely any person, possessing the means, will need no other inducement to cultivate this beautiful tribe than that which is held forth in the exquisite beauty and delightful fragrance of this lovely plant. In company with the above, Messrs.



THIS PAGE IS LOCKED TO FREE MEMBERS
Purchase full membership to immediately unlock this page



Never be without a book!

Forgotten Books Full Membership gives universal access to 797,885 books from our apps and website, across all your devices: tablet, phone, e-reader, laptop and desktop computer

A library in your pocket for \$8.99/month

Continue

*Fair usage policy applies

OPERATIONS FOR JUNE.

ANNUALS, BIENNIALS, &c., in pots, should be encouraged to grow by increasing the size of the pots, and adding rich soil, composed of loam and rotten dung, peat and leaf or vegetable mould, mixed in different proportions, according to the nature of the plants.

BULBS that have done flowering should now be allowed to get dry by degrees, by reducing the quantity of water. Insects of every kind should be carefully watched and destroyed by syringing, fumigating with tobacco, and other practical means.

CREEPERS should now be duly attended to; for if suffered to grow out of order at this season, it is more than probable that they will continue in confusion the whole summer.

DAHLIAS about the middle of the month, if the weather is favourable, may now be turned out into the open border; if the nights prove cold after they are out it is advisable to employ a temporary shading.

ERICA cuttings, as also cuttings of most greenhouse plants, may now be put in. Greenhouse plants may now safely be put out of doors in a somewhat sheltered situation.

GERANIUMS, (PELARGONIUMS) will now be in full bloom, avoid a scarcity of water and they will continue beautiful a long time. Cuttings now struck will, if managed well, flower prettily in the autumn.

IXIAS in a growing state should be encouraged by giving them a judicious supply of water, &c.

PINKS, CARNATIONS, &c., now propagated succeed well. A gentle heating hotbed covered with open sandy or gravily soil answers well; the soil before receiving the pipings should be gently watered, and afterwards made smooth with the spade: in putting in the pipings it is best to make each pretty fast in the soil, and to cause the latter to settle properly round them, it is well to give a little water previous to placing on the glass, after which they must be carefully and judiciously secluded from the sun and air, in consequence of which scarcely any water will be required.

PLANTS hitherto kept in the greenhouse, pits, or frames, but supposed to be sufficiently hardy to endure the open air, may now be carefully planted out in a sheltered situation, where shade, water, and other requisites should be timely attended to.

POLYANTHUSES. The seed of these plants will now begin to ripen: as soon as the pods turn colour, cut them and put them into a dry airy secure place for more perfect maturation.

STOVE plants of most kinds may still be propagated, whether by seeds, suckers, or layers. Seed pots should be plunged in a gentle hotbed—pots of cuttings should also have a gentle bottom heat; guard against damp by wiping the condensed vapour of the inside surface of the glasses, judiciously admitting a little fresh air in the morning, &c.

TUBEROSES should now have plenty of heat, pot room, and a free supply of water.



Calliopsis lobata

Wm. D. Smith sculp.



THIS PAGE IS LOCKED TO FREE MEMBERS

Purchase full membership to immediately unlock this page

DELVE INTO FANTASY, MAGIC, MYTHOLOGY & FOLKLORE

Forgotten Books'
Full Membership gives
access to 797,885 ancient
and modern, fiction and
non-fiction books.

Continue

*Fair usage policy applies

CATTLEYA LABIATA.

(CRIMSON-LIPPED CATTLEYA).

CLASS.
GYNANDRIA.ORDFR.
MONANDRIA.NATURAL ORDER.
ORCHIDEÆ.

GENERIC CHARACTER.—See Vol. I. p. 151.

SPECIFIC CHARACTER.—*Plant* an epiphyte. *Stems* not often numerous, angulated, terminated by two stiff leaves from six to eight inches long, dark-green on the upper surface, brownish beneath. *Spathes* large, foliaceous, of a chocolate colour. *Flower-stalk* smooth, supporting from two to six flowers. *Sepals* linear. *Petals* membranaceous, broad, acute, undulated, both of a transparent lilac colour. *Lip* obovate, obtuse, undivided, undulated, colour a beautiful rich crimson.

THE superb species here represented was imported some years ago by Mr. William Swainson from Brazil, since which flowers have been produced in various collections of Orchideæ in this country. The number of flowers ordinarily produced vary from two to four, rarely six, in a cluster; and as the plants in general are small, it seldom happens that more than one stem is seen in flower at once: however, there is an exception to this in the collection at Wentworth, where the finest specimens in cultivation exist; there we have seen, on one plant, no less than four flowering stems, each with four large splendid flowers quite perfect at the same time. The exquisite delicacy and glowing splendour of this specimen when in its greatest perfection, at which time we saw it, defies all attempts to describe; but to form an idea of its appearance, we must picture to our minds a plant producing four times the number of flowers, as shown in the accompanying drawing, all large and perfect.

Our plant flowered in the Orchideæ house at Chatsworth, last autumn, in the manner here represented: the flowers were large, and the colours so exquisite and rich, that it was absolutely impossible for the artist to reach them, either in richness or transparency. Dr. Lindley very justly speaks of the species thus: "It is not merely the large size of the flowers, and the deep rich crimson of one petal contrasted with the delicate lilac of the others, that constitute the loveliness of this plant; it owes its beauty in almost an equal degree to the transparency of its texture, and

the exquisite clearness of its colours, and the graceful manner in which its broad flag-like petals wave and intermingle when they are stirred by the air, or hang half drooping half erect, when at rest and motionless."—*See figure below.*

In the Orchideæ house, it thrives in an atmosphere less moist than is usually given to other branches of this family; it succeeds well at Chatsworth, treated in a temperature ranging from 70° to 75° Fahrenheit, carefully watered at the roots, and now and then moderately sprinkled over the top with water; it should be grown in coarse peat, mixed with a good proportion of broken pots, so that the water may pass off freely. It is multiplied by separations at the roots; a portion of the root with one stem attached (if two, so much the better) seldom fails of pushing a bud, which, if well managed, soon becomes established and secure. For further particulars on the genus, see Vol. I. p. 151.

Plants may be procured of Messrs. Loddiges, Rollison, or Knight, at a reasonable cost.

The generic name is given by Dr. Lindley, in compliment to his early friend, Wm. Cattley, Esq., a munificent promoter of Botany.

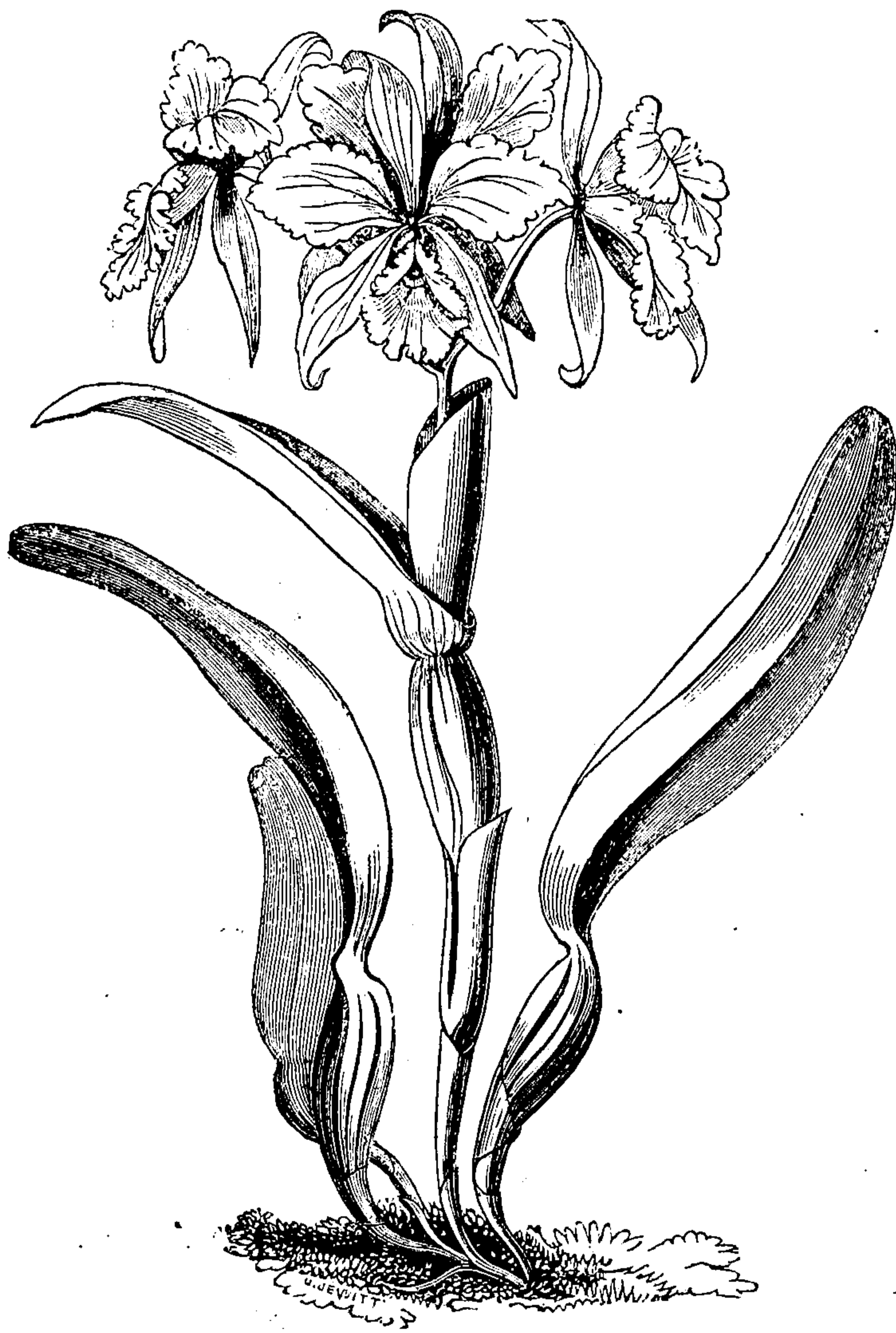



THIS PAGE IS LOCKED TO FREE MEMBERS
Purchase full membership to immediately unlock this page



Never be without a book!

Forgotten Books Full Membership gives universal access to 797,885 books from our apps and website, across all your devices: tablet, phone, e-reader, laptop and desktop computer

A library in your pocket for \$8.99/month

Continue

*Fair usage policy applies



Begonia odorata

JULY 11837.





THIS PAGE IS LOCKED TO FREE MEMBERS

Purchase full membership to immediately unlock this page

DELVE INTO FANTASY, MAGIC, MYTHOLOGY & FOLKLORE

Forgotten Books'
Full Membership gives
access to 797,885 ancient
and modern, fiction and
non-fiction books.

Continue

*Fair usage policy applies



*Epacris
impressa*

*Epacris
variabilis*

JULY. 1833

H. J. Ten. L. C. - Smith sculp.



THIS PAGE IS LOCKED TO FREE MEMBERS
Purchase full membership to immediately unlock this page



Never be without a book!

Forgotten Books Full Membership gives universal access to 797,885 books from our apps and website, across all your devices: tablet, phone, e-reader, laptop and desktop computer

A library in your pocket for \$8.99/month

Continue

*Fair usage policy applies

EPACRIS VARIABILIS.

(VARIABLE EPACRIS.)

CLASS.
PENTANDRIA.ORDER.
MONOGYNIA.NATURAL ORDER.
EPACRIDEÆ.

GENERIC CHARACTER.—See Vol. I. page 52.

SPECIFIC CHARACTER.—An evergreen greenhouse shrub from two to three feet high. *Stem* branched, smooth. *Leaves* ovate, sessile, tapering to the point. *Corolla* tubular, three or four times longer than the calyx. *Flowers* red, or blush.

THIS delicate and handsome species of *Epacris* is a native of Van Diemen's Land, from whence it was introduced in 1829.

In the greenhouse, about the months of February and March, it produces, in dense clusters, its charming pendulous blush flowers, which continue in perfection for a long time, and which, from the change in colour they assume during their gay existence, never fail to attract and interest every observer.

Ample directions for culture, &c., will be found in Vol. I. page 52, Vol. II. pages 88, 120, and 144, and Vol. III. page 115.

The drawing was made from a plant that flowered in the greenhouse at Chatsworth last spring.

EPACRIS IMPRESSA.

E. impressa and *E. variabilis*, when both in flower together, make an elegant and gay contrast, for, as both produce an immense display of rich bloom nearly at the same time, the variation in colour heightens the lustre of each, so that they are extremely pretty, and certainly there are no plants more acceptable to or worthy of a place in the greenhouse; indeed in the spring, if not the most showy, they are among the most interesting in the months of March and April, when they are generally in their highest perfection. See Vol. II. page 97.

This species is also a native of Van Diemen's Land, and is besides found in New Holland. It was introduced by Messrs. Mackey (Lowe), nurserymen, at Clapton, in 1825.

The generic name, *Epacris*, applies to the natural habit of the species to grow on the top of hills; hence the derivation from *epi*, upon, and *akros*, the uppermost.



THIS PAGE IS LOCKED TO FREE MEMBERS

Purchase full membership to immediately unlock this page

DELVE INTO FANTASY, MAGIC, MYTHOLOGY & FOLKLORE

Forgotten Books'
Full Membership gives
access to 797,885 ancient
and modern, fiction and
non-fiction books.

Continue

*Fair usage policy applies

THE COW TREE.

ONE of the most remarkable phenomena of the vegetable world is the cow tree, described by Humboldt in the following terms, as growing in the Cordilleras of South America :—“ On the barren flank of a rock grows a tree with dry and leathery-like leaves ; its large woody roots can scarcely penetrate into the stony soil. For several months in the year not a single shower moistens its foliage. Its branches appear dead and dried ; yet, as soon as the trunk is pierced, there flows from it a sweet and nourishing milk. It is at sunrise that this vegetable fountain is most abundant. The natives are then to be seen hastening from all quarters, furnished with large bowls to receive the milk, which grows yellow and thickens at the surface. Some empty their bowls under the tree, while others carry home the juice to their children. The milk obtained by incisions made in the trunk is glutinous, tolerably thick, free from all acrimony, and of an agreeable and balmy smell. It was offered to us in the shell of the trituros, or calabash tree. We drank a considerable quantity of it in the evening before we went to bed, and very early in the morning, without experiencing the slightest injurious effect. The viscosity of the milk alone renders it somewhat disagreeable. The negroes and free labourers drink it, dipping into it their maize, or cassava bread.” Mr. Lockhart has subsequently afforded the following additional particulars concerning this tree :—“ The *Palo de vaca* is a tree of large dimensions. The one that I procured the juice from had a trunk seven feet in diameter, and it was one hundred feet from the root to the first branch. The milk was obtained by making a spiral incision into the bark. The milk is used by the inhabitants wherever it is known. I drank a pint of it without experiencing the least inconvenience. In taste and consistence, it much resembles sweet cream, and possesses an agreeable smell.”

Receptacles for Milk.—All the various milky juices reside in the bark and leaves, and are not found in the wood. They are contained in distinct receptacles, and may be extracted by means of incisions chiefly in the upper parts of plants, and which do not extend deeper than the bark ; otherwise, they would be diluted and impoverished by mixing with the ascending sap. M. Berthollet has recorded a remarkable instance of the harmless quality of the sap in the interior of a plant, whose bark is filled with a milky juice of a poisonous nature. He describes the natives of Teneriffe as being in the habit of removing the bark from the *Euphorbia Canariensis*, and then sucking the inner portion of the stem in order to quench their thirst, this part containing a considerable quantity of limpid and non-elaborated sap. The reservoirs which contain the milky juice of the wild lettuce (*Lactuca virosa*), are so remarkably irritable, that the slightest touch is sufficient to cause it to be ejected from them with considerable force. When this plant is about to flower, if an insect happens to crawl over the surface of the stalk anywhere near its summit, a jet of milk is propelled. In general, plants which secrete these milky juices, love the light ; few are found to affect shady situations, and none are aquatics. By cultivation, their noxious properties may be greatly subdued.—*Dr. Lardner's Encyclopædia*, BOTANY.

ADDITIONAL REMARKS ON THE GENUS CHRYSANTHEMUM.

CHRYSANTHEMUM literally means "golden flower," from (*χρυσος*) chrysos, gold, and (*ανθος*) anthemon, flower. This plant is a native of Japan, and true to the general character of the vegetation of that singular, but singularly delightful, country, it combines the beauty and splendour of a tropical plant, with the hardiness of one of the northern mountains. The Chinese are very partial to this plant, attend much to its cultivation, and produce very fine specimens, which are often grown in china vases, and are highly ornamental, either as in-door or out-door decorations.

The Chrysanthemum was introduced into the British islands from France, about the year 1790, and it very speedily recommended itself to the general attention of cultivators. The beauty of its leaves, the number and elegance of its flowers, its powers of endurance, its delightful fragrance, and above all its standing in all its glory when the Dahlia, and the other autumnal beauties of the border, have yielded to the severity of the weather, are strong commendations of it. It will thrive in almost any soil, or any situation. In borders it looks well as a bush, but requires to be tied to a stake, as its branches, though tough, are flexible, and if left to themselves would have a ragged and straggling appearance. If, however, it is trained on a south wall, it flowers more finely than in any other situation.

Its culture is so simple, that it is any body's flower. The best soil for it is fresh light loam and turf chopped up with frame manure; and the plants should be kept moist during the summer months. It is also easily propagated by cuttings, by layers, by dividing the roots, and by seeds. If new varieties are sought after, the last mode must be resorted to; but for mere multiplication of the plants, the simplest way is by dividing the roots about the month of March. This may be done by a sharp knife, preserving two or three, or more shoots, according to taste. These may be planted in borders or in pots, and placed in a south-west aspect during the summer. Plants produced by cuttings, are, however, probably the best for cleanness of growth and beauty of flower. April or May is the time for taking cuttings from the stock. Five or six inches is a good length for the taller varieties, and the shortest should not be less than four inches long. They should be cut immediately below a joint, and the two bottom leaves taken off, as otherwise they would rot and injure the plant. The cuttings may be planted in small pots, in the composition above-mentioned, with the addition of a little sand or leaf mould. A shaded border is the best place for those pots, and should be plunged in the earth up to the rims, and covered with hand glasses till they strike. The best glass is thin window glass, for the blown glasses are generally thick at the tops, and thus concentrate the rays of the sun like burning glasses, and scorch the plants. These hand glasses should not be more than six inches high, as larger ones are found not to answer so well. The plants and glasses should be covered with a mat during the

hot sun and the night. In June, or at the beginning of July, they may be transplanted into larger pots, and placed in a south-west aspect. They will now require frequent watering, and the tops should be pinched off to make them bushy. In September they should be again shifted into large pots, not less than a foot both in diameter and depth, and should be filled with the same soil as recommended above; or at this season they may be planted out in the borders.

When they show flower-buds, which they generally do in the month of October, the smaller ones should be carefully thinned out, as this greatly promotes the growth of those which are left, and is indeed the only way of procuring an extraordinary bloom. Until November they should be liberally supplied with water, but during that month the soil and air are generally humid enough for rendering artificial watering quite superfluous. Treated in this manner, if the weather is open, and the precaution is taken of suspending a light covering over them during severe nights, these plants will continue in flower till January, and communicate to the otherwise wintry borders no small degree of the freshness and beauty of summer.

RHODODENDRON ARBOREUM.

THERE is now in the conservatory at Chatsworth a fine plant of the above species, which has upwards of two hundred bunches of flowers upon it. It is almost impossible to convey an accurate idea of an object so magnificent as that plant, which is about eighteen feet high, covered with rich scarlet blossoms. The proper management of this species has long been an object of the cultivator's care; it is often found well grown, but rarely, if ever, seen in any thing like the perfection of the present object. Most cultivators under-pot it, which is a mistaken notion: indeed it is quite natural to suppose that a plant which attains to the size of an ordinary forest tree should require plenty of pot room before flowers can be produced of a natural and luxuriant size.

The soil should be varied according to the size of the plants. Seedling plants grow best if potted in very sandy peat; as the plant progresses a little loam should from time to time be added, until the plant is about five or six feet high, more loam should be used at each shifting; when the plant attains a large size, equal parts of loam and peat may be used; by strict attention to the above directions, and supplying the plant plentifully with water during the growing season, fine healthy blooming plants will be the result. It is much to be regretted that so fine an object should not be hardy enough to grow in the open air, but from repeated trials, which have failed in various parts of the country, we are fearful this desirable object will never be attained.

Numberless beautiful varieties have been raised, some almost as handsome as the parent itself; most of the crosses have been between this species and *Rhododendron Ponticum*; these varieties are quite hardy, but they blossom rather early to be seen in high perfection in the open air. Mr. Burn, gardener to Lord Aylesbury,



THIS PAGE IS LOCKED TO FREE MEMBERS
Purchase full membership to immediately unlock this page



Never be without a book!

Forgotten Books Full Membership gives universal access to 797,885 books from our apps and website, across all your devices: tablet, phone, e-reader, laptop and desktop computer

A library in your pocket for \$8.99/month

Continue

*Fair usage policy applies

collection of greenhouse plants; it is now flowering very abundantly at the above nursery. *Callionema pulchra*. This elegant greenhouse plant, from the gracefulness of its habit of growth, and the beauty of its pink blossoms, justly merits a place in every collection; it is something after the habit of an *Erica*, but the branches are pendent and extremely slender; the foliage is very small, it flowers rather abundantly, and it is, when in flower, a most beautiful object; Messrs. Henderson have a great abundance of it. *Sedum cœruleum*. This, though not a new plant, is, now it is densely covered with its pretty little blue blossoms, a most delightful and pleasing object, and is highly worthy of every attention that may be bestowed upon it.

MR. KNIGHT'S, Chelsea. *Peristeria cerina*. A new and beautiful species of *Peristeria*, after the habit of *P. pendula*, but with bright yellow flowers, is now flowering at the above named nursery in great perfection; and no collection of Orchideæ should be destitute of it. *Eriostemon burifolium*. A remarkably fine and well grown plant of this beautiful species is also now in flower, and it is certainly superior to *E. cuspidatum*, both in habit and in foliage, but not in the size or beauty of its flowers; neither of them should be by any means wanting in a good collection. Mr. Knight has recently made a very considerable accession to his stock of Orchideæ, from the Mauritius, Manilla, &c.; among which are many decidedly new and highly valuable species; he has especially some very fine imported plants of various species of *Cattleya*, as well as many others equally valuable.

MESSRS. LODDIGES, Hackney. *Angræcum caudatum*. This singular orchideous plant, is now producing a fine spike of flowers at the above nursery, and the long tails of its flowers (from which it takes its specific name) give it a very curious and interesting appearance, although it has no claims to real beauty. *Maxillaria cristata*. This is a plant of very different character to the last, and, though smaller than most of the species of this genus, possesses no ordinary share of beauty; and it is a highly valuable as well as rare orchideous plant; the flowers proceed from the base of the pseudo-bulb, and usually come in pairs; the flower-stem inclines a little downwards, and is about three inches in length; the flowers are of a fine purple colour, with numerous beautiful white spots, and when held up to the light the whole appears perfectly transparent; the labellum is white, and finely fringed or bearded, which gives it a most interesting and pretty appearance; and, though by no means so large and splendid as some of the flowers of other orchideous plants, it is one of the prettiest and neatest plants of the tribe with which we are acquainted. *Bolbophyllum barbigerum*. This is a small, but very interesting little orchideous plant, and is now producing its singular little flowers at the above nursery. *Eriostemon cuspidatum*. This, though not a new plant, is still we believe a rare one, and a fine plant in the collection of the above gentleman is now flowering in great profusion; it is certainly a very ornamental plant, and Messrs. Loddiges appear to possess a good stock of it.

MR. LOW'S, Clapton. Owing to the immense quantity of Orchideæ, which Mr. Low has recently exported to the Continent, his stock of this beautiful tribe

is considerably diminished, but he will no doubt shortly have it replenished; we are happy to see that the taste for cultivating Orchideæ is thus extending itself to the Continental horticulturists, as we are sure that there is no tribe of plants more worthy of the cultivator's care. Mr. Low has recently raised a hybrid *mimulus*, between *M. cardinalis* and *M. variegatus*; the plant possesses all the habit of *M. cardinalis*, while the flowers are like those of *M. variegatus*, only of a deeper colour; it is now beautifully in flower. He has likewise a new plant from China, which he received under the name of *Oxalis Barleri*, now in flower, the flowers of which are yellow, and very similar to those of an *Oxalis*, but the plant is of a shrubby habit; and if it should prove a species of *Oxalis*, it will very probably be *O. fruticosa*.

MESSRS. ROLLISON'S, Tooting. *Oncidium Lanceanum*. The splendid plant of this beautiful species in the possession of Messrs. Rollison, is again throwing up two or three fine spikes for flower, and we anticipate that when in flower it will be even superior to what it was when it flowered last year; we should think the flowers will be out in about a month, or perhaps less. *Broughtonia sanguinea*. There are some remarkably fine plants of this species now producing their beautiful purple blossoms in great perfection, at the above nursery; and as they are growing on logs of wood, and suspended from the roof of the house, they have a very pretty appearance. Messrs. Rollison have lately made an importation of several curious orchideous plants from Ceylon, as well as some from Manilla, among which are some valuable new ones. There is also at the above nursery a most splendid collection of Cape and other bulbs, now in flower; many of which are extremely beautiful, and some new. Their tulips have likewise made a most brilliant display, but are now losing their beauty.

MR. YOUNG'S, Epsom. *Lemnanthes Douglassi*. This elegant little annual was introduced by Mr. Douglas, and named in honour of him; a small bed of it now in flower at the above nursery, has a most pleasing and beautiful appearance, and is one amongst the many truly excellent annuals introduced to this country by that indefatigable botanist; it makes a most delightful feature in the flower garden in the summer if planted out in a bed, or even singly on a border. *Rhododendron multimaclatum*. This is a most beautiful *Rhododendron*, with a white ground and light brown spots, which Mr. Young has received from the Continent, and is, with many others similarly beautiful, now exhibiting its magnificent blossoms in great abundance at the above nursery. Mr. Young has a most splendid collection of hardy *Pæonies*, now in flower, and it would be difficult to imagine a more beautiful sight than a large bed of these, with all the brilliancy of their colours, present to the eye of the beholder. Here also fine beds of those charming little annuals, *Collinsia bicolor*, *Leptosiphon androsaceus* and *densiflorum*; *Nemophila insignis*, and various others equally pretty, are flowering in the greatest possible perfection, and contribute greatly to beautify and enliven the place. *Penstemon Scholeri*. This is a plant of great merit, as it is an evergreen shrub, and a remarkably free flowering plant, and the flowers are strikingly beautiful.

ON THE CULTURE OF NEW AND RARE PLANTS,
IN THE PRINCIPAL NURSERIES AND PRIVATE GARDENS IN THE
VICINITY OF LONDON.

On training Clianthus Puniceus against a wall.

This splendid plant, which is now becoming so generally and deservedly admired, and is cultivated by almost all persons who possess a collection of plants, is found by Messrs. Rollison, of Tooting, to succeed admirably well when trained against an open wall, with a slight protection during the winter; as a remarkably fine plant in their possession has stood out for two successive winters with no other protection than a slight covering of mats; and, though the young and tender shoots were slightly injured, yet the plant is now growing very luxuriantly, and flowering in the greatest possible perfection; and any person who is at all acquainted with the striking beauty of this plant, when in flower, will readily admit that it must make a most charming feature in a collection of ornamental climbing plants.

A longer acquaintance with the habits of this beautiful plant, has convinced cultivators that it will not thrive well (as was once thought) in peat soil; but, on the contrary, requires a good rich loam with a portion of well rotted manure incorporated, as peat soil is best adapted for plants of a hard woody habit and slow growth; while such as grow very luxuriantly, and are rather of a succulent habit (like the *Clianthus*) require a stronger and more nutritious soil, and a great supply of water during the summer season.

On shading Orchideæ.—At this season of the year it is, or should be, a point of first importance in the cultivation of *Orchideæ*, to attend properly to shading the plants from the direct and powerful rays of the sun; and, as most persons use canvass for this purpose, we will just lay before our readers a system of Messrs. Loddiges, Hackney, which appears to us to be one of the most simple and efficient methods of shading we have ever seen; it is that of twisting straw bands to as great a length as may be required, but so slightly as to leave a quantity of loose straws hanging from them; these are then placed on the roof of the *Orchideæ*-house, at about the distance of a foot from each other, and kept on at all times during the summer season; thus preventing the trouble arising from the putting on and taking off of canvass; they also so effectually shade the house, that it is never found necessary to give any air to it, neither do they in cloudy weather obstruct the light too much; but, on the contrary, when artificial heat is employed, they assist materially in retaining it. It may, perhaps, be well to add, that this system seems to answer perfectly well with Messrs. Loddiges, and as it is thus proved to be efficient, we think no one will dispute its cheapness or simplicity. Although, perhaps, this system may be best suited for *Orchideæ*, it may likewise be extended to any other collection of plants that require shading, as, indeed, Messrs. Loddiges have some of their stove plants treated in a similar way, as well as their succulents, and there is very little doubt but that *Camellias* that are kept in a house with a south aspect would be very much benefited by it.



THIS PAGE IS LOCKED TO FREE MEMBERS

Purchase full membership to immediately unlock this page

DELVE INTO FANTASY, MAGIC, MYTHOLOGY & FOLKLORE

Forgotten Books'
Full Membership gives
access to 797,885 ancient
and modern, fiction and
non-fiction books.

Continue

*Fair usage policy applies

HYDROLEACEÆ.

WIGANDIA CARACASANA. Caraccas Wigandia. This tender stove shrub is a native of the Caraccas, where it was first found by Humboldt and Bonpland. It was introduced into this country by His Grace the Duke of Northumberland, from the Royal Garden at Berlin. The plant has a very beautiful appearance when well grown; the flowers are delicate, lilac, and open in succession for a long time. *Bot. Reg.* 1966.

THE GREEK VALERIAN TRIBE (POLEMONIACEÆ).

LEPTOSIPHON DENSIFLORUS. Thickly-flowered Leptosiphon. A very handsome, perfectly hardy annual, introduced by Mr. Douglas, from California. It is in many respects similar to *L. androsaceus*, but the leaves have more numerous and narrower segments, and the flowers are much larger. Flowers lilac, more or less inclining to a deep rose colour, or purple. *Bot. Mag.* 3578.

THE POPPY TRIBE (PAPAVERACEÆ).

PLATYSTEMON CALIFORNICUM. Californian Platystemon. A highly interesting annual, for the introduction of which our gardens are indebted to Mr. Douglas, who sent the seeds to the Horticultural Society from California. It flowers in June and July, and proves perfectly hardy, ripening its seed very copiously. Flowers pale sulphur yellow. *Bot. Mag.* 3579.

THE COFFEE TRIBE (CINCHONACEÆ).

PAVETTA CAPFRA, South African Pavetta. This very pretty species is a native of South Africa, and was received at the Edinburgh Botanic Garden from Kew in 1835; and flowered freely in the stove in the end of April and beginning of May. It is an erect shrub with white flowers, ascending branches and obovate leaves. *Bot. Mag.* 3580.

THE UMBELLIFEROUS TRIBE (UMBELLIFERÆ).

XANTHOSIA ROTUNDIFOLIA. Round-leaved Xanthosia. This is a curious umbelliferous plant, very much unlike in habit to the majority of individuals of this extensive natural order. It was received at the Glasgow Botanic Garden from Messrs. Loddiges, and flowered in June. The stem is shrubby, about a foot high, slightly branched, the leaves are alternate, partially clothed with deciduous down. Flowers white, with the anthers and upper part of the germ red. It is a native of New Holland. *Bot. Mag.* 3852.

THE CRUCIFEROUS TRIBE (CRUCIFERÆ).

SCHIZOPETALON WALKERI. Mr. Walker's Schizopetalon. This is a very interesting plant, a native of Chili, whence it was introduced in 1821 by the late Mr. Walker. It is a fibrous-rooted plant, with a decumbent stem about a foot high, sparingly clothed with short forked hairs. Flowers white and fragrant; leaves linear, toothed, an inch or two in length, attenuated at the base. "It is a hardy annual, thriving best in light sandy soil, and is increased by seeds, which it perfects but sparingly, and that only in dry and warm summers. To hasten their

growth, and thereby insure the maturing of seeds, the young plants should be raised in a frame, and planted out in a sunny border about the middle of May." *Brit. Fl. Gar.* 387.

THE HEATH TRIBE (ERICACEÆ).

RHODODENDRON PHÆNICEUM; *var.* SPLENDENS. Splendid Rosebay. This very showy, dwarf, branching, variety of Rhododendron was raised by Mr. Wood, gardener to Mrs. May at Sydenham, from a plant of *R. phæniceum*, that had been fecundated by *R. catawbiense*. It produces its blossoms freely and in abundance, and from their size, and rich reddish purple colour, it will prove a valuable addition to the conservatory during the early spring months. *Brit. Fl. Gar.* 385.

CLASS II.—PLANTS WITH ONE COTYLEDON (MONOCOTYLEDONEÆ).

THE CORN FLAG TRIBE (IRIDACEÆ.)

SISYRINCHIUM GRANDIFLORUM. Large-flowered Sisyrinchium. This interesting addition to our hardy border flowers was obtained through Mr. Douglas, during his first visit to the north-west regions of America. The whole plant is a dull green. "It far surpasses all the other species of the genus, in the size and rich purple colouring of the flowers. The plant is perennial, and is readily multiplied by divisions or seeds. The soil best suited to it is a mixture of peat and loam." It produces its flowers in March. *Brit. Fl. Gar.* 388.

THE ORCHIS TRIBE (ORCHIDEÆ).

BRASSIA LANCEANA. Mr. Lance's Brassia. This is a truly handsome plant, blossoming at very different seasons. It is a native of Surinam, and also of the Province of Rio Negro, but was introduced from the former place by Mr. Lance. The bulbs are oblong, ovate, and furrowed, especially when old; two leaves arise from the summit of the bulb, and two or three at the base, between oblong and lanceolate. The peduncle arises from the base of the bulb, terminating in a long raceme of large fragrant flowers, which are yellow, spotted with blood red. *Bot. Mag.* 3577.

ONCIDIUM PUMILUM. Mr. Herbert's Dwarf Oncidium. This is a very singular and pretty little epiphyte, introduced from Brazil by the Hon. and Rev. W. Herbert, of Spofforth, in whose collection it flowered for the first time about ten years ago. It has no bulbs, but a few roots proceed from the base of the stem; the leaves are oblong, and acute at the point, of a deep green colour. The scape arises from the axilla of one of these leaves, and, including the flowers, is scarcely so long as the foliage. Flowers yellow, spotted with brown and red. It flowers in April and May. *Bot. Mag.* 3581.

BOLBOPHYLLUM COCOINUM. The Cocoa-nut Bolbophyllum. A pretty little species imported by Messrs. Loddiges from Sierra Leone, where it grows on the trunk of the Cocoa-nut Palm. It is related to *B. recurvum*, and others in its neighbourhood; but is readily known by the pale flesh-coloured flowers, serrated petals, and concave short lip, delicately ciliated towards the base. It flowered with Messrs. Loddiges for the first time in January, 1835. *Bot. Reg.* 1964.

REVIEW OF "THE FLOWER GARDEN."

THE first part of this neatly executed and very desirable little work appeared on the first of June, and we confess ourselves highly pleased with it; so will, unquestionably, every one who has read it with attention, and who is equally interested in the delightful occupations to which its contents are intended to lead to an acquaintance with, viz., those of "*The flower-garden.*" In the first part now before us, the following subjects are treated of, each of which, we must say, contains a deal of useful matter; but, to enable the reader to appreciate the merit of the whole we shall give an extract of one of the heads, viz., that which treats the subject of Laying-out Flower-Gardens. The whole will be complete in twelve parts, at one shilling each. This little work we cordially recommend to our readers, because we feel convinced it will be not only very useful, but highly interesting, to all lovers of plants, and particularly to those engaged in their cultivation.

1. A pretty coloured group of hardy Annuals, and another of Green-house Perennials.
2. The Flower-garden.
3. On Laying out Flower-gardens.
4. The Italian Style of Gardening.
5. The French Style of Gardening.
6. The Dutch Style of Gardening.
7. The English Style of Gardening.
8. Rock-work and Root-work.
9. Flowering plants suitable for ornamental Rock-work, arranged into Annuals, Biennials, and Perennials.
10. Water Basins.
11. Select Aquatic Plants.
12. Planting.
13. Growth of Plants, Absorption, Food, Soils, &c. &c.

ON LAYING OUT FLOWER-GARDENS.

A Flower-garden is chiefly cultivated to gratify the individual taste of the possessor, to display the same to others, or to fulfil both these designs, which do not always coincide. When the object is confined to the gratification of individual taste, it matters little in what manner the Flower-garden is laid out, inasmuch as a great part of the pleasure derived from it must consist in the exercise of the mind in planning, and occasionally altering the disposition of the beds or borders. But most people, while they wish to gratify their own tastes, also like to please others, or at least to have their approval; and of course some skill and study are requisite in order to succeed in this respect. Much of the effect of a Flower-garden depends upon the peculiar forms and disposition of the beds, as well as on the arrangement of the plants with regard to height and colour; and these again must be partly regulated by the space of ground, and the class of plants made choice of, as well as



THIS PAGE IS LOCKED TO FREE MEMBERS
Purchase full membership to immediately unlock this page



Never be without a book!

Forgotten Books Full Membership gives universal access to 797,885 books from our apps and website, across all your devices: tablet, phone, e-reader, laptop and desktop computer

A library in your pocket for \$8.99/month

Continue

*Fair usage policy applies

channel of a dried-up brook, with irregular edgings of broken turf and stone to match. "Our present landscape gardeners," says Sir Henry Steuart, "have made a merit, and are singularly vain, of disfiguring their most beautiful subjects with clumps and plantations, and even approaches, in the most zig-zag and grotesque figures, which are ten times more hideous and unpicturesque than the worst productions of their predecessors. A late powerful writer (Sir Walter Scott) says, "their plantations, instead of presenting the regular or rectilinear plan, exhibit nothing but a number of broken lines, interrupted circles, and salient angles, which are as much at variance with Euclid as with nature. In cases of enormity, they have been made to assume the form of pincushions, of hatchets, of penny tarts, and breeches, displayed at old clothesmen's doors. In all these they tell you they are imitating nature."

"There is not a man," says Sir Henry Steuart, "whose taste has been formed on any correct model, that does not feel and acknowledge the beauty of those elegant forms, the oval, the circle, and the cone; and there are few well educated persons who will for a moment compare to them a multitude of obtuse and acute angles, great and small, following each other in fantastical and unmeaning succession. It is to be hoped that there is discernment enough in our present race of artists to see the propriety of adopting, or restoring those fine figures, the oval and the circle." Not only the oval and the circle, however, are proscribed to make way for artist-like arabesques, but all corresponding things must be avoided for the sake of irregularity; and to escape from the style satirised by Pope, in which

"Grove nods at grove, each alley has its brother,
And half the garden just reflects the other."

A striking metropolitan example of the present taste for non-correspondent and irregular patch-work, may be seen in the sloping garden ground, in front of the Hospital at the Southwark end of London-bridge. The main plot is an imperfect oval, lying sideways on the slope; and the smaller ones, at each side, are of no describable form, except, perhaps, that of an old carpet, with the worn parts cut away to make it look a little respectable. How badly this appears, either in contrast or in harmony with the square style of the edifice and the adjacent roads, must strike every observer to be as much out of taste as one of Salvator Rosa's rugged ravines and banditti would appear, if patched into the centre of the foreground of a classical landscape of Claude, or as a furze bush would look in the midst of a bed of tulips.

Even this style, however, does not appear to me to be so reprehensible as the finically grotesque figures, of which a metropolitan example may be seen in the garden now (1837) laying out in the front of Bethlem Hospital, and a more grotesque one in the gardens of the Botanical and Horticultural Society at Birmingham, the plan of the borders of the pleasure-ground having been apparently borrowed from old-fashioned tamboured muslin or printed calicoes. "Involutions," as Sir Walter Scott says, speaking of this style of laying out grounds, "of bizarre and extravagant irregularity, resembling the irregular flourishes in Corporal Trim's

harangue. If the visitor applies to know the meaning of the angles and contortion, in Petruchio's language—

'What! up and down, carved like an apple tart.
Here's snip, and nip, and cut, and slish, and slash,
Like to a censer in a barber's shop—'

he receives the plausible reply, that what he now sees is not the final result of the designer's art; but that all this fantastic zig-zaggery, which resembles the traces of a dog scampering among snow, is only a set of preparations. It resembles, we are told, a lady's tresses in papillotes, as they are called, and in training for the conquests which they are to make when combed into becoming ringlets." (*Quart. Review, March, 1828.*) The examples referred to by Sir Walter are considered by Mr. W. S. Gilpin as having been produced by the mischievous effects of conceit and ignorance.

The style in question is evidently much more artificial, and consequently stiff, as may be seen in the Birmingham borders, than the Dutch-clipt hedges and yew trees cut out in pretended imitation of peacocks, and the like; and it is rather surprising that the cutting satire in the paper just quoted has not done as much to banish these bizarreries, as was done by Pope's witty paper in the *Guardian*. "People of the common level of understanding," says Pope, "are principally delighted with the little niceties and fantastical operations of art, and constantly think that finest which is least natural. A citizen is no sooner proprietor of a couple of yews, but he entertains thoughts of erecting them into giants, like those of Guildhall. I knew an eminent cook, who beautified his country seat with a coronation dinner of greens, where you see the champion, &c., flourishing on horseback at one end of the table, and the queen in perpetual youth at the other." (*Guardian, No. 173.*) There was at least meaning in the cook's madness, but what the grotesque figures at Bethlehem, or the mazy tambour work at Birmingham means, it would be hard to discover, unless it can be traced to the artificial love of curves and irregularity.

The truth is, that it is much more natural; and M. Cousin justly and profoundly considers it an innate taste in man to admire regularity than irregularity. Nay, it is even so in natural productions, as is seen in the re-entrant angles of mountain valleys, in the balanced arms and heads of trees, and particularly in the exact correspondence of the right and left sides of all animal bodies. It is, therefore, a narrow, partial, and incorrect principle to represent nature as irregular. At the same time, it seems to be quite forgotten that gardens are not natural, but artificial productions, nearly as much so as houses, or temples, or statues; any attempt to conceal the art, any attempt to make a garden not appear like a garden, but like a natural wood, or a natural wilderness, must prove abortive or ridiculous. I am well aware that it is maintained by some as a general principle of the fine arts, that they should be as exact imitations of nature as possible; grapes so natural that birds would peck at them, and the like; but nothing would be easier than to disprove the doctrine. If a tragedian, in *Macbeth*, for example, were to imitate nature so closely as to deceive the audience into a belief in the reality, hundreds would leap

from their seats upon the stage to snatch the dagger from his hand ; and the same would be the case if a painter were to represent the scene on canvass, so as to deceive the on-lookers. Yet we never heard of a tragedy so interrupted, nor of anybody ever dreaming of rescuing Laocoon in the celebrated statue from the

" ————— enormous asp,
Enforcing pang on pang, and stifling gasp on gasp."

And nobody ever mistook one of the bright summer landscapes of Claude Lorraine, the golden autumnal scenes of Cuyp, the embowering woods of Hobbima, or the rock-margined brooks of Ruysdael, for windows looking out into a natural prospect. Were it so, indeed, the representations of a real landscape in a camera obscura, or even in a common looking-glass, would be preferred to the finest paintings ; and a corner of Coombe Wood, or of Wimbledon Common, with its

" Blossomed furze unprofitably gay,"

and its blue speedwell, wild thyme, and buttercups, would be preferred to the adjacent royal gardens at Kew, with all their artificial accompaniments of exotics.

There is an old rule bearing, that "it is art to conceal art," (*ars est celare artem*,) which has led to much fruitless effort in practice, and many idle remarks of critics in all the fine arts, and in none more than in laying out gardens. Mr. R. T. Knight thus applies it to the subject in question :

" More cautiously will taste its stores reveal,—
Its greatest art is aptly to conceal ;
To lead with secret guile the prying sight
To where component parts may best unite,
And form one beauteous well-connected whole,
To charm the eye, and captivate the soul."

THE LANDSCAPE.

Neill, as it appears to me, is much more correct in his ingenious interpretation of this much-abused rule. In ornamental gardening, he says, "our art lies in endeavouring to adapt the productions of nature to human taste and perceptions ; and if much art be used, do not attempt to hide it. A human production cannot be made perfectly natural ; and, if held out as such, it becomes an imposition. It is the artifice, not the design ; the labour, and not the art, which ought to be concealed." (*Encycl. Britan.*, art. "Gardening.") In other words, the labour should be completed and finished ; for it is only half-done and untidy labour which appears offensively, and gives the idea of want of skill, or want of exertion—in a word, stiffness—which is always bad.

It is gratifying to find these broad, and I think incontrovertible, principles advocated by some of the highest authorities. "The grand natural scene," says the Rev. W. Gilpin, "will always appear so superior to the embellished artificial one, that the picturesque eye, in contemplating the former, will be too apt to look contemptuously on the latter. This is just as arrogant as to despise a propriety because it cannot be classed with a cardinal virtue. Each mode of scenery has its station. A wild forest scene, contiguous to a noble mansion, would be just as absurd as an embellished one in the midst of a forest.



THIS PAGE IS LOCKED TO FREE MEMBERS

Purchase full membership to immediately unlock this page

DELVE INTO FANTASY, MAGIC, MYTHOLOGY & FOLKLORE

Forgotten Books'
Full Membership gives
access to 797,885 ancient
and modern, fiction and
non-fiction books.

Continue

*Fair usage policy applies

OPERATIONS FOR JULY.

AZALEAS continue to propagate from cuttings of the young wood; take the cuttings off close to the plants, and plant them in sand under a handglass in a shady situation.

CAMELLIAS, wanted to flower early, may be brought forward by placing them in a warm stove or greenhouse; those not required for early flowering may remain out of doors till the end of September or beginning of October.

CARNATIONS may be layered, or raised from cuttings taken off at the third joint, and planted under a handglass. Seedlings may towards the end of this month be transplanted six inches apart, in light rich soil.

CALCEOLARIAS intended to flower late in the autumn should now have the branches cut down to within an inch of the soil, and be top dressed. Cuttings may still be put in with success.

CHIMONANTHUS FRAGRANS may be now layered with success; cuttings of the young wood will also grow, if planted in sand under a glass, and the pot be plunged in a gentle bottom heat.

CYCLAMENS would do better turned out of the pots in which they flowered, and planted in an open somewhat sheltered border.

DAHLIAS. If young plants are desired, cuttings may still be put in with success.

GREENHOUSE PLANTS still continue to propagate.

MIGNONETTE, to stand the winter in pots, should be sown about the middle of the month, in light, sandy, fresh soil, quite free from dung.

ORANGE STOCKS, &c., may be budded; cuttings may also be put in with success.

PINKS may yet be propagated by pipings. (See last month.)

RANUNCULUSES should be taken up, and spread in a dry, airy situation, previously to laying them by. Roots put in last month will flower about the middle of September. It would be well also to plant some in pots for flowering in the greenhouse in winter.

ROSE-TREES may be successfully budded; the varieties of the China-rose do best budded early in the season.

VIOLETS may still be propagated by divisions or cuttings.

ROCKETS, &c., when out of flower, cut down the stems nearly to the ground, and new shoots will spring up, from which a plentiful supply of cuttings may be gathered.



Clintonia pulchella

AUG 1847



THIS PAGE IS LOCKED TO FREE MEMBERS
Purchase full membership to immediately unlock this page



Never be without a book!

Forgotten Books Full Membership gives universal access to 797,885 books from our apps and website, across all your devices: tablet, phone, e-reader, laptop and desktop computer

A library in your pocket for \$8.99/month

Continue

*Fair usage policy applies

mode of cultivation. "The seeds," he says, "were sown about the middle of September in a well-drained pot, the soil used being light and sandy; the seeds being barely covered with a very fine top soil, the pot was placed in a moist heat till the plants were of sufficient size to prick off into sixty-sized pots of the same light sandy soil, putting five or six in a pot; they were then placed in the greenhouse, near the glass, or in an airy situation, till the following February, when they were shifted again into small sixties, filled with soil composed of two parts leaf mould enriched with strong well-decomposed manure, one part good loam and sand, and placing three plants in a pot; they were then placed in a house the temperature of which was kept at from 55° to 60°. In a short time they began to grow vigorously, being shifted regularly as they required it, each time into one size larger, until they finally flowered in a twenty-four size. After the plants had been in heat some time, and began to show symptoms of flowering, they were taken back to the greenhouse, where they have been in flower these two months, presenting at the present time (June 16th) one entire mass of bloom, some of them being trained in cones two feet high and three feet in circumference.

"This plant is also well adapted for planting out in beds in the open air during the summer months; and I have invariably found that, in proportion to the richness of the soil, the larger was the flower and finer the bloom. When in growth, like most of the *Lobeliaceæ*, they require plenty of water."



F.W.S. del. et sculp.

Clematis Sieboldii



THIS PAGE IS LOCKED TO FREE MEMBERS

Purchase full membership to immediately unlock this page

DELVE INTO FANTASY, MAGIC, MYTHOLOGY & FOLKLORE

Forgotten Books'
Full Membership gives
access to 797,885 ancient
and modern, fiction and
non-fiction books.

Continue

*Fair usage policy applies



CLEMATIS SIEBOLDII.

(SIEBOLD'S CLEMATIS.)

CLASS.
POLYANDRIA.ORDER.
POLYGYNIA.NATURAL ORDER.
RANUNCULACEÆ.

GENERIC CHARACTER.—*Involucre* absent, or growing in the form of a calyx under the flower. *Calyx* consists of from four to eight coloured sepals. *Petals* none. *Carpels* many, collected together, surmounted and terminated by a long feathery tail.

SPECIFIC CHARACTER.—A climbing greenhouse shrub with ternate leaves. *Leaflets* lobed, end lobe cordate acuminate, side lobes obtuse. *Leaves* and *Leaf-stalk* quite smooth. *Calyx* consisting of from five to seven parts, ovate, acute, greenish white. *Sepals* smooth. *Carpels* numerous.

THIS, though not so showy as many other species of the genus *Clematis*, nevertheless highly merits a place in every collection. The plant grows freely, and the flowers are produced in abundance, which, notwithstanding their singular colour, make a striking appearance with the dark-green leaves, and upon the whole is very ornamental. It is a native of Japan, and imported by Dr. Siebold.

Our drawing was made from a plant in full flower at Messrs. Whitley and Osborne's, Fulham, in June last. It grows well, as do all the species, in light loamy soil, and young plants increase freely planted in soil under a glass. They also increase readily by layering the young shoots, which may be successfully done about August or September, or by seeds; some species ripen their seeds perfectly and plentifully.

The name of *Clematis* is derived from *Clema*, the branch of a vine, on account of most of the species having the habit of the vine—that is to say, they have a climbing habit like it.



THIS PAGE IS LOCKED TO FREE MEMBERS
Purchase full membership to immediately unlock this page



Never be without a book!

Forgotten Books Full Membership gives universal access to 797,885 books from our apps and website, across all your devices: tablet, phone, e-reader, laptop and desktop computer

A library in your pocket for \$8.99/month

Continue

*Fair usage policy applies



*Murellia
stipulacea*



*Murellia
Heisteria*

 *Smith del.*



THIS PAGE IS LOCKED TO FREE MEMBERS

Purchase full membership to immediately unlock this page

DELVE INTO FANTASY, MAGIC, MYTHOLOGY & FOLKLORE

Forgotten Books'
Full Membership gives
access to 797,885 ancient
and modern, fiction and
non-fiction books.

Continue

*Fair usage policy applies

MURALTIA HEISTERIA.

(HEISTER'S MURALTIA.)

GENERIC CHARACTER.—See preceding.

SPECIFIC CHARACTER.—A greenhouse shrub, with triquetrous (three sides, or angles), stiff leaves produced in bundles. *Branches* purberulous. *Flowers* axillary, purple, sessile.SYNONYME.—*Polygala Heisteria*.—Bot. Mag. t. 340.

THIS species is equally interesting, and worthy of a place in every greenhouse collection with the preceding. It is also a native of the Cape of Good Hope, and is in habit so similar that the treatment recommended for it will also suit this. We omitted to say, when speaking of that species, that it is at all times necessary to water with caution, and never to neglect changing the pot the moment the roots show signs of matting.

The drawings were made from plants which are now in full flower in the greenhouse at Chatsworth.

Muraltia is a name given in compliment to John Von Muralt, a Swiss botanist. The majority of the species were for a long time included in the well known genus *Polygala*, but for scientific reasons it has been found necessary to include them under the present type, *Muraltia*.

In Don's System of Gardening and Botany, Vol. I. page 364, the following species are enumerated and arranged thus:—

The synonymes are in italics.

Leaves mucronately-pungent at their apex.

Muraltia conferta (Crowded-leaved Muraltia); flowers purple.	Muraltia juniperifolia (Juniper-leaved Muraltia); flowers purplish.
— <i>Polygala thymifolia</i> .	— <i>Polygala juniperifolia</i> .
— brevifolia (Short-leaved Muraltia); flowers purple.	— ericæfolia (Heath-leaved Muraltia); flow- ers red mixed with white.
— serpyllifolia (Wild thyme-leaved Mural- tia); flowers purple.	— <i>Polygala mixta</i> .
— alopecuroides (Foxtail-like Muraltia); flowers purple.	— sprengelioides (Sprengelia-like Muraltia); flowers purple.
— <i>Polygala alopecuroides</i> .	— satureioides (Savoury-like Muraltia); flowers purple.
— trinerva (Three-nerved leaved Muraltia); flowers purple.	— tenuifolia (Fine-leaved Muraltia); flowers purple.
— squarrosa (Squarrose Muraltia); flowers purplish.	— <i>Polygala tenuifolia</i> .
— <i>Polygala squarrosa</i> .	— aspalatha (Aspalathus-like Muraltia); flowers purple.

- Muraltia diffusa (Diffuse-branched Muraltia); flowers purple.
 — *Polygala micrantha*.
 — virgata (Twiggy-branched Muraltia); flowers small purple.
 — *Polygala micrantha*.
 — linophylla (Flax-leaved Muraltia); flowers purple.

- Muraltia macrocera (Long-horned Capsuled Muraltia); flowers purple.
 — mixta (Mixed flowering Muraltia); flowers purple mixed with white.
 — *Polygala mixta*.
 — ciliaris (Ciliate-leaved Muraltia); flowers purple.
 — var. laxiuscula.

Leaves bluntish at the apex.

- Muraltia pubescens (Pubescent Muraltia); flowers purple.
 — humilis (Dwarf Muraltia); flowers purple.
 — *Polygala humilis*.
 — depressa (Depressed Muraltia); flowers purple.

- Muraltia brevicornu (Short-horned capsuled Muraltia); flowers purple.
 — obovata (Obovate-leaved Muraltia); flowers purple.

Species not sufficiently known, and which are perhaps, many of them, identical with some of those described above.

- Muraltia phyllicoides (Philica-like Muraltia); flowers purple.
 — *Polygala phyllicoides*.
 — thymifolia (thyme-leaved Muraltia); flowers purple.
 — *Polygala thymifolia*.
 — pilosa (Hairy-leaved Muraltia); flowers purple.
 — *Polygala pilosa*.
 — filiformis (Filiform-branched Muraltia); flowers purple.
 — *Polygala filiformis*.
 — pauciflora (Few-flowered Muraltia); flowers purple.
 — *Polygala pauciflora*.
 — Burmanni (Burmans' Muraltia); flowers probably purple.
 — *Polygala ericoides*.

- Muraltia Poiretii (Poiret's Muraltia); flowers purple.
 — *Polygala ericoides*.
 — dumosa (Bushy Muraltia); flowers purple.
 — *Polygala dumosa*.
 — laxa (Lax Muraltia); flowers probably purple.
 — *Polygala laxa*.
 — fasciculata (Fasciculate-leaved Muraltia); flowers purple.
 — *Polygala fasciculata*.
 — striata (Striated Muraltia); flowers probably purple.
 — *Polygala striata*.
 — parviflora (Small-flowered Muraltia.)
 — *Polygala parviflora*.



THIS PAGE IS LOCKED TO FREE MEMBERS
Purchase full membership to immediately unlock this page



Never be without a book!

Forgotten Books Full Membership gives universal access to 797,885 books from our apps and website, across all your devices: tablet, phone, e-reader, laptop and desktop computer

A library in your pocket for \$8.99/month

Continue

*Fair usage policy applies



S. del. et sculp.

Chorizema ovata

AUG 1837.

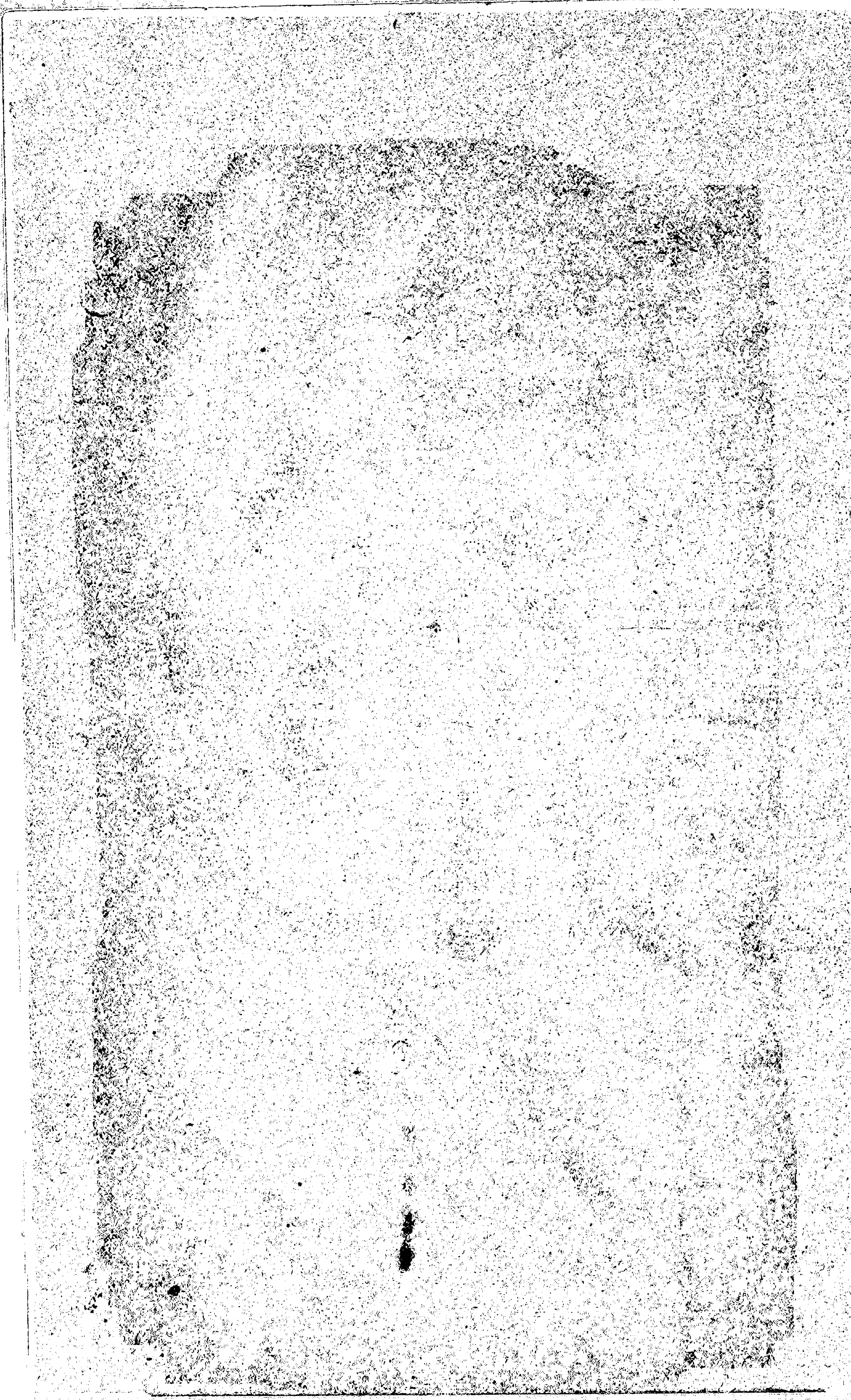



THIS PAGE IS LOCKED TO FREE MEMBERS

Purchase full membership to immediately unlock this page

DELVE INTO FANTASY, MAGIC, MYTHOLOGY & FOLKLORE

Forgotten Books'
Full Membership gives
access to 797,885 ancient
and modern, fiction and
non-fiction books.

Continue

*Fair usage policy applies

general recommended is an equal mixture of very sandy peat and loam; this composition for plants, like those we are now speaking of, does not fully accord with our experience; the soil used here will, therefore, be found to differ. We select a quantity of peat, carefully avoiding such as does not contain a good deal of fibre, or that has not a considerable portion of white sand equally mixed with it, rejecting as entirely worthless all such as inclines to be stiff, or very sandy; to this is added no more than one fourth of mellow sandy loam; the whole is then carefully blended and examined, and if the grains of sand are found not to touch, or nearly so, throughout the whole, so as to give it a greyish cast, what more sand is thought sufficient is thrown in and properly mixed up. The soil is never sifted, this practice is discarded as taking out the most essential part, namely, the fibre; but after being well broken up with the back and edge of the spade, what lumps remain too large are reduced with the hands. Any soil naturally retentive, or that inclines to become close, is always objectionable for these, and in short all hair-rooted plants. Plants, on their first removal after striking, are put into 60 sized pots in the above soil, being very particular in putting no less than two inches good drainage (potsherds) at the bottom of each; they are afterwards removed again to the propagating house, being first gently watered with a fine rose; here the atmosphere is congenial to them in this state, and will consequently cause the roots to push, and prepare them for a removal into an atmosphere more suited to their constitution, which should take place in about a week, as the young roots will have taken hold of the new soil. The next situation sought for them is a pit or frame (any aspect), where they can be placed near the glass, and be shaded from the hot sun: during fine weather air should be admitted freely, and the plants carefully, though sufficiently, watered every evening. They are finally placed in the greenhouse, as near the glass as possible; but, if avoidable, never place them opposite the ventilator when the air is admitted, this will prove injurious to them, as the house will require to be freely ventilated; if the air is admitted from the roof they cannot sustain any injury. The house should be shut up in the evening. As these plants suffer from over potting, it is necessary here to caution against so dangerous a practice.

One thing that greatly accelerates the growth, and tends to ensure success, in cultivating these plants, is to avoid setting the pots where their sides are likely to be dried much by the sun; this practice materially injures the young roots, which always like to be between the side of the pot and the soil, and consequently sickens and weakens the plant. In the nurseries about London they have an excellent practice of substituting for the wooden shelves of the stages slabs of blue slate, which seem to be readily procured of any length between four and seven feet; this is not only very durable, but has an extremely neat appearance, and is as well a

great benefit to the plants, being very comfortable and cool to their roots in hot weather, and less liable to get dry. There is also a practice of laying a little sandy gravel for the pots to stand on; this, when watered a little, retains a degree of moisture, and prevents drought, and consequently the sides of the pots cannot dry; it moreover feeds the leaves, and strengthens the whole plant; but when this is practised it is necessary to observe the strictest caution in watering. The advantages of keeping the floor damp, and employing other materials for that purpose, is only available in summer, and should not, therefore, be practised in the winter, when the plants are not growing. In the winter it is not the growth of the plants that is the cultivator's study, it is rather how he shall best keep them alive until the return of the growing season; and of all to be thought of on this head perhaps the first and most important is the preservation of their roots; to ensure these, watch hourly against too much moisture arising from over watering, &c.; take care that the drip does not fall into any of the pots, and in damp weather, or where moisture begins to appear, and to remain long about the pots, on the stages or on the bottom of the sashes, &c., a very little fire may be applied with advantage in the evening, and in the morning after, if the weather suits, admit a little fresh air for an hour, or according to the state of the weather, carefully and effectually observing to keep out at all times cold winds and frost.

Potting is in general looked upon as of minor importance, but the truth is, a badly potted plant, however healthy when shifted, never thrives. It is instructive to turn out the balls of several recently potted plants, and observe where the soil is loose or in holes, how it affects their growth; where the soil is compact, and properly put about the roots, the plant will grow freely and root well; but, on the other hand, if the soil is put in loose, or left in holes, the plant never properly thrives, but languishes, and ultimately dies if allowed to remain in that state; it is therefore necessary to place the soil compactly and properly about the roots when potting, never forgetting to effectually drain every pot as before directed. The propagation of these plants is a difficulty which every gardener acknowledges and experiences; but even this becomes comparatively easy when steadily and attentively followed up. The few following hints will be useful:—The cuttings should be taken off while the wood is young, and carefully prepared; take off the bottom leaves with a sharp knife, and make a clear cut just through the joint: the cutting pot should be drained and filled to within two inches of the top, with the soil before spoken of, on the top of this put a layer of quite clean white sand, into which plant the cuttings, making a little hole for their reception with a small prepared stick; when the pot is full, give them a steady watering with a fine rose; after which place a clean glass over them. In this state they may be removed to the propagating house, where the temperature

should not sink below sixty-five degrees, and plunged into a little saw-dust. They should be effectually shaded from the sun, which can easily be done by placing a sheet of coarse paper between it and the glass inside the house, not as is usual on the roof outside. The glass should be wiped quite dry every morning, and the cuttings when necessary carefully watered. The object of filling the pot up to within two inches of the top with soil, is to enable the young roots, as soon as they are formed at the bottom of the cuttings, to take off at once into the soil, which greatly strengthens them, and prevents the check which would ensue when potted off, if allowed to form their roots wholly in the sand. Seeds of many of the species ripen in abundance, and as they in general vegetate freely, plants may be readily increased from them. They may be sown in any light soil, carefully avoiding any among which dung is incorporated; placed in a gentle heat, securely shaded from the sun, and judiciously watered, they will come up well; and when four proper leaves are formed they may be potted off in the manner before directed for cuttings.

“*Chorizema* is derived from $\chi\omicron\rho\omicron\varsigma$, *choros*, a dance, and $\zeta\epsilon\mu\alpha$, *zema*, a drink. This plant was originally discovered by Labillardiere, upon the south-west coast of New Holland, at the foot of the mountains near a spot where, after being tantalized with finding many salt springs, his party had just met with an ample supply of fresh water. This welcome refreshment, of which he speaks feelingly in his book, seems to have suggested the name.” *Don, Gard. Dict.*

Our drawing was taken from a fine plant which flowered beautifully in the collection of Messrs. Young, Epsom, in June last.



THIS PAGE IS LOCKED TO FREE MEMBERS
Purchase full membership to immediately unlock this page



Never be without a book!

Forgotten Books Full Membership gives universal access to 797,885 books from our apps and website, across all your devices: tablet, phone, e-reader, laptop and desktop computer

A library in your pocket for \$8.99/month

Continue

*Fair usage policy applies

Society's garden in June, 1834. During the time of growing, I keep them on a shelf, or trellis, in front of the greenhouse, having upright lights about five feet high, and I give them plenty of air, carefully avoiding the least application of heat, which would draw them up weak, cause the flowers to be much smaller, and very much injure their colours. By these means I have had them continue in bloom for full four weeks."

THE PURPLE BEECH TREE.

IN a work devoted chiefly to floriculture, it may appear irrelevant to allude to forest trees; the subject, however, of this short article is one of surpassing beauty, and it possesses so many interesting qualities that we may be permitted to be a little excursive in its favour.

We must first view it botanically, and herein shall derive great assistance from that instructive little work, "Ladies' Botany," by Dr. Lindley. The Linnæan system refers the beech (*Fagus*) to its twenty-first class, *Monœcia*, a term derived from two Greek words, *monos*, one, and *oikos*, a house or residence. The flowers are of two sexes, separately situated on the same tree: the characters of the genus or family are:—*Barren*, or *male* flower, a roundish catkin (*amentum*). *Perianth* single, of one leaf cut into six parts. *Stamens* from five to ten, or more. *Fertile flowers* two, within a four-lobed prickly covering (*involucrum*). *Perianth*, or calyx, single, pitcher-shaped (*urceolate*, from *urcéolus*, a jug or pitcher), cut into about five small lobes. *Germen* three-celled, one only being fertile. *Styles* three. *Nuts*, or "mast," covered with the involucrum, containing only one seed.

This peculiar structure is elucidated by the following quotation; which also exhibits the style in which plants are investigated by the professors of the *natural*, or we would rather call it the physiological, system of botany. We now refer our readers to Letter X. of the work just named, p. 138 to 147; and for our present purpose extract, nearly verbatim, the following passages. There is a most interesting *natural order*, which, in consequence of its containing the *oak*, is termed the oak tribe; it includes also the sweet chestnut, the beech, the horn-beam, and the hazel (page 138).

"In the *oak* itself the involucre is formed of a great many rows of scales, which gradually grow larger and harder, and more numerous, and at last become what you call the *cup* of the acorn; a part you would never have guessed could have been made out of a number of little leaves, if you had not watched their successive changes. The *ovary* at first contains three cells, and each cell two young seeds; but, in obedience to the constant command of nature, one of the seeds grows faster than the rest, presses upon the other cells and seeds, and gradually crushes them, till at last, when the acorn is ripe, all trace of them has disappeared." The *oak* is the type or pattern of the tribe or order. "In the *beech* the involucre originally consists of a vast quantity of little thread-like leaves, which enclose a couple of pistils. These leaves gradually grow together, and over

the pistils, so as to form a prickly hollow case, which completely encloses the nuts; at last the case rends open spontaneously into three or four woody pieces, and makes room for the nuts, or *mast*, to fall out. As in the oak one of the ovules destroys all the others, so that out of six young seeds but one is found in the ripe nut: here, however, you may generally find the five that have perished remaining like little brown specks sticking to the top of the cell of the nut."

It will be apparent that the more simple classification of Linnæus teaches the student to examine the structure of the flower, and apparent organs of fructification, and it has contrived to establish a set of characters with wonderful precision, whereby a person, very slightly acquainted with plants, may be able to judge of the systematic relationship of any subject that he sees for the first time. But it instructs him no farther. The natural system enters into anatomical details; it dissects minutely, and, to be appreciated, requires a patient assiduity of research, and a considerable acquaintance with physiological structure: it is the system of the learned, and combines the sciences of vegetable physiology and botany.

The purple beech, the immediate object of our remarks, is a variety of the common forest beech, and is propagated by inarching upon that stock. It is introduced occasionally, but by no means so extensively as, for its grace and beauty, it ought to be. Every development, from the first enlarging of the buds, is striking: the involution of the numerous tender leaves under the external covering ought to be closely investigated, as a subject of admiration and praise. When in full foliage the leading tint is a profound purple, with a glossy metallic lustre, hence the vulgar term of copper-beech. But a deep green prevails equally with the purple; and, under certain angles of light, this green tint predominates. If a person place himself before a well-formed tree, and between it and the sun, and look steadily at every part of the tree upon which the sun's rays fall, he will behold the various and varying shades in all their beauty. The leaves on the spray, most enlightened, will exhibit the utmost intensity of the purple, illuminated with a golden lustre. The internal branches, those in shadow, but which still present their foliage in the direction of the sun, will appear green, with occasional lines and patches of brown and purple, which afford a striking relief to the prevailing tint. At certain periods, at the approach of autumn, green predominates; but the veins of the leaves are always purple, or of a full dark hue.

The figure of the tree is extremely graceful, and it may be so trained as to overarch a considerable space of a lawn, the extremities of the branches nearly touching the surface, and forming a bowery shade to which we may appositely apply the first line of the pastoral Latin poet,

"Tityre, tu patulæ recubans sub tegmine fagi."

It is generally supposed that the shadow of the beech is inimical to grass; but we have now before us a fine specimen on a lawn, the herbage of which forms an unbroken green covering: the texture and substance of the grass are lax and somewhat feeble, but there is no want of verdure. The soil is a sandy loam over chalk; a soil which the beech affects. We, this spring, sifted soot and Bath-coal ashes over the grass, and there has been a manifest improvement.

MAHOGANY.

THOUGH the Mahogany be a native of too warm a climate to allow of its cultivation as a timber-tree in this country, yet it is applied to so many uses; and is so well adapted for most of them, that some notice of it is required.

There are three species of mahogany:—common mahogany (*Swietenia mahogani*), *Swietenia febrifuga*, and *Swietenia chloroxylon*: the first being a native of the West India Islands, and the central parts of America, and the second and third natives of the East Indies. They all grow to be trees of considerable magnitude; the first and second being among the largest trees known. They are all excellent timber:

Swietenia mahogani is, perhaps, the most majestic of trees; for though some rise to a greater height, this tree, like the oak and cedar, impresses the spectator with the strongest feelings of its firmness and duration. In the rich valleys among the mountains of Cuba, and those that open upon the bay of Honduras, the mahogany expands to so giant a trunk, divides into so many massy arms, and throws the shade of its shining green leaves, spotted with tufts of pearly flowers, over so vast an extent of surface, that it is difficult to imagine a vegetable production combining in such a degree the qualities of elegance and strength, of beauty and sublimity. The precise period of its growth is not accurately known; but, as when large it changes but little during the life of a man, the time of its arriving at maturity is probably not less than two hundred years. Some idea of its size, and also of its commercial value, may be formed from the fact that a single log, imported at Liverpool, weighed nearly seven tons; was, in the first instance, sold for £378; re-sold for £525; and would, had the dealers been certain of its quality, have been worth £1000. Mahogany of remarkable fineness is very costly, as we shall show when we come to speak of fancy-woods.

As is the case with much other timber, the finest mahogany trees, both for size and quality, are not in the most accessible situations; and as it is always imported in large masses, the transportation of it for any distance overland is so difficult, that the very best trees, both on the island and the main-land—those that grow in the rich inland valleys—defy the means of removal possessed by the natives. Masses of from six to eight tons are not very easily moved in any country; and in a mountainous and rocky one, where much attention is not paid to mechanical power, to move them is impossible. In Cuba the inhabitants have neither enterprise nor skill adequate to felling the mahogany trees, and transporting them to the shore; and thus the finest timber remains unused.

The discovery of this beautiful timber was accidental, and its introduction into notice was slow. The first mention of it is that it was used in the repair of some of Sir Walter Raleigh's ships, at Trinidad, in 1597. Its finely-variegated tints were admired; but in that age the dream of El Dorado caused matters of more value to be neglected. The first that was brought to England was about the beginning of last century, a few planks having been sent to Dr. Gibbons of London, by a brother who was a West India captain. The Doctor was erecting a house in King-street, Covent Garden, and gave the planks to the workmen, who rejected them



THIS PAGE IS LOCKED TO FREE MEMBERS

Purchase full membership to immediately unlock this page

DELVE INTO FANTASY, MAGIC, MYTHOLOGY & FOLKLORE

Forgotten Books'
Full Membership gives
access to 797,885 ancient
and modern, fiction and
non-fiction books.

Continue

*Fair usage policy applies

where it has room to spread, it is of much better quality, and puts out large branches, the junctions of which with the stem furnish those beautifully curled pieces, of which the choicest veneers are made. When among rocks and much exposed the size is inferior, and there is not so much breadth or variety of shading, but the timber is far superior, and the colour is richer. The last description is by far the strongest, and is therefore the best adapted for chairs, the legs of tables, and other purposes, in which a moderate size has to bear a considerable strain. Since the produce of Jamaica has been exhausted there are only two kinds known in the market; bay-wood, or that which is got from the continent of America, and Spanish wood, or the produce of the islands chiefly of Cuba and Hayti. Though the bay-wood be inferior to the other, both in value and in price, it is often very beautiful, and may be obtained in logs as large as six feet square. It is, however, not nearly so compact as the other; the grain is apt to rise in polishing; and if it be not covered by a water-proof varnish it is very easily stained. It also gives to the tool in carving, and is not well adapted for ornaments. Spanish wood cuts well, takes a fine polish, resists scratches, stains, and fractures much better, and is generally the only sort upon which much, or delicate, workmanship should be expended. The colours of mahogany do not come well out without the application of oil or varnish, and if the best sorts be often washed with water, or long macerated in it, they lose their beauty and become of a dingy brown. The red is deepened by alkaline applications, especially lime-water; but strong acids destroy the colours. When the surface is covered by a colourless varnish, which displays the natural tints without altering any of them, good mahogany appears to the greatest advantage.

The *Febrifuga*, or East India mahogany, is a very large tree. It grows in the mountainous parts of central Hindostan, rises to a great height, with a straight trunk, which, towards the upper part, throws out many branches. The head is spreading, and the leaves have some resemblance to those of the American species. The wood is of a dull red colour, not so beautiful as common mahogany, but much harder, heavier, and more durable. The natives of India account it the most lasting timber that their country produces, and therefore they employ it in their sacred edifices, and upon every occasion where they wish to combine strength with durability.

The *Chloroxylon* is chiefly found in the mountains of the Sircars, that run parallel to the bay of Bengal, to the N.E. of the mouth of the river Godavery. The tree does not attain the same size as either of the former, and the appearance of the wood is different.

It is of a deep yellow, nearly of the same colour as box, from which it does not differ much in durability, and could be applied to the same purposes.

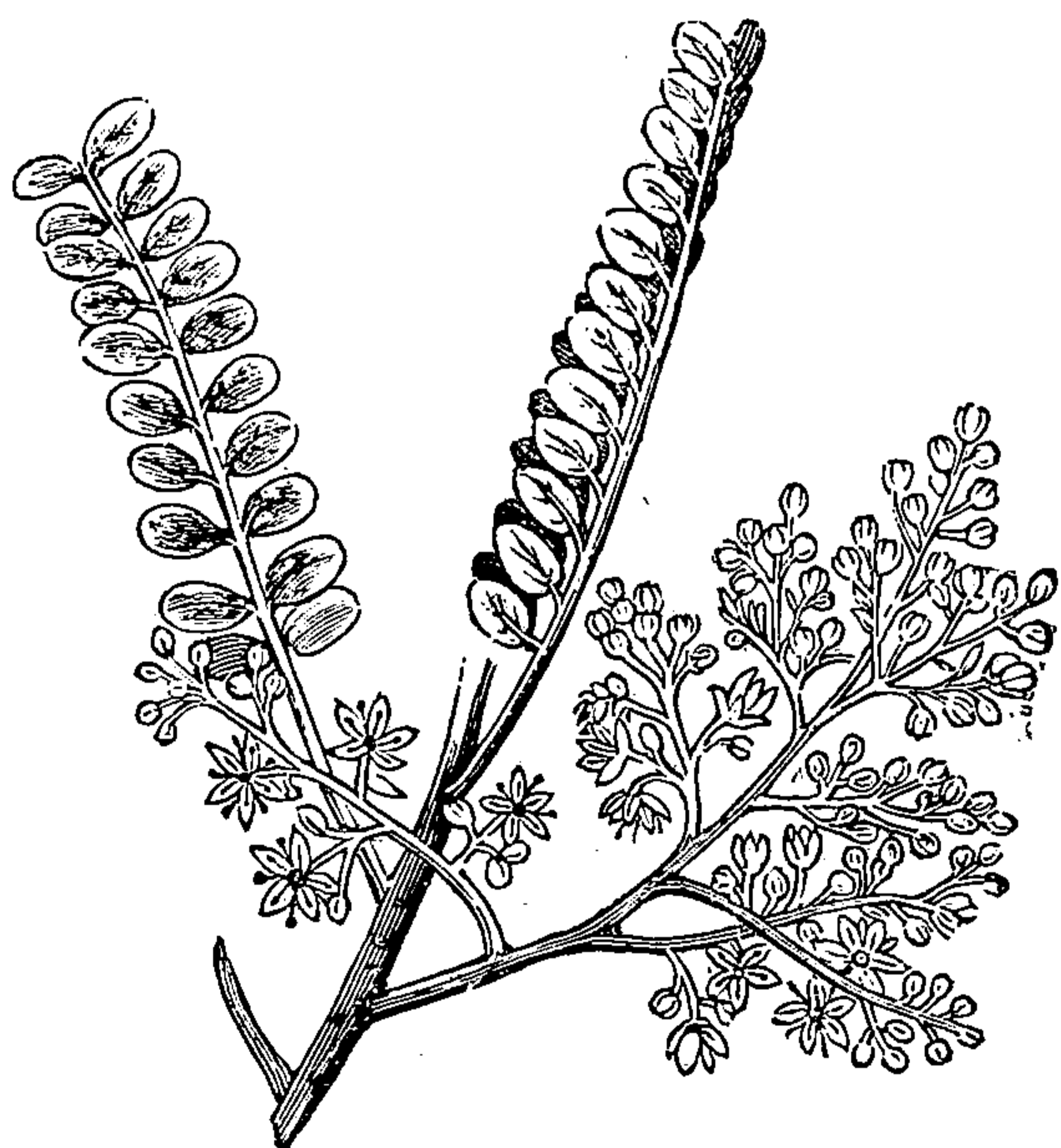

NEW AND RARE PLANTS,

FIGURED IN THE LEADING BOTANICAL PERIODICALS FOR JULY.

CLASS I.—PLANTS WITH TWO COTYLEDONS (DICOTYLEDONEÆ).

THE RANUNCULUS TRIBE (RANUNCULACEÆ).

DELPHINIUM INTERMEDIUM; *Var. PALLIDUM*. Pale-blue variable Larkspur. This is a lovely variety of *D. intermedium*. It grows seven feet high in rich ground, with a firm stem of a delicate glaucous green; its leaves are thin and destitute of the smallest trace of hairiness, while its long branched racemes of nodding sky-blue flowers, give a most graceful appearance to the terminations of the branches. It differs from the common form of the species in the perfect nakedness even of the leaves, and in the lobes of the small hairy lateral petals being more rounded, or perhaps shorter than usual. *Bot. Reg.* 1969.

THE PEA TRIBE (LEGUMINOSÆ).

PSORALEA ORBICULARIS. Round-leaved Psoralea. A hardy herbaceous plant, with long tough slender creeping stems, from which the leaves spring up on stalks about six inches long, ovate-obtuse leaves, and purplish pink flowers. It is a native of California, whence seeds were sent by Mr. Douglas. It flowers in June and July. *Bot. Reg.* 1971.

SPARTIUM ACUTIFOLIUM. Sharp-leaved Spanish Broom. Whether this is more than a variety, I cannot say. It appears to be a distinct species; for its leaves are not only longer and taper pointed, instead of being rounded at the point, but the racemes are more lax, and the manner of growth more graceful. Otherwise it is like the Spanish Broom. It was raised in the garden of the Horticultural Society, from Turkish seeds, and proves a hardy shrub, with fragrant flowers. *Bot. Reg.* 1974.

LOBELIACEÆ.

SIPHOCAMPYLUS BICOLOR. Two-coloured Siphocampylus. A perennial suffruticose plant, with slightly angular branches, and alternate finely serrated greenish leaves. Flowers solitary, of a beautiful scarlet and yellow colour. It was introduced by Mr. A. Gordon, from Georgia, United States, and is considered quite hardy. *Brit. Fl. Gar.* 389.

SPARTIUM JUNCEUM; *var. ODORATISSIMUM*. Fragrant Broom. This variety is distinguished by its more slender and spreading habit, more silky leaves and shoots, and, lastly, by its smaller and more fragrant flowers. It is equally hardy with the common variety, and the flowers are still more fragrant. *Brit. Fl. Gar.* 390.

THE BALSAM TRIBE (BALSAMINEÆ).

IMPATIENS SCAPIFLORA. Stemless Balsam. This is a very interesting plant, with roundish cordate smooth leaves, and handsome flesh-coloured flowers, terminating round a scape, from a span to eight or ten inches high. *Bot. Mag.* 3587.

CLASS II.—PLANTS WITH ONE COTYLEDON (MONOCOTYLEDONEÆ).

(ORCHIDEÆ).

PLEMOTHALLIS SAUROCEPHALA. Lizard-headed Plemothallis. This is a curious but by no means a handsome species; the leaves are fleshy, of an ovate oblong figure; the flower spike springs from a kind of spathe in their axil, formed by the leaf and stem; sometimes two, and sometimes more are produced, upon these the little variegated flowers are seated. It flowers in September. *Bot. Reg.* 1968.

BOLBOPHYLLUM SALTATORIUM. Dancing Bolbophyllum. This is a most interesting plant, resembling *B. barbigerum*; and, like that species, it was imported from Sierra Leone, by Messrs. Loddiges, in whose collection the present species flowered in December last. *Bot. Reg.* 1970.

EULOPHIA MACRASTACHYA. Long-spiked Eulophia. A handsome species of this extensive genus, inhabiting shady woods in Ceylon. It is one of the easiest of orchideous plants to cultivate, and produces its graceful racemes of green and yellow flowers abundantly towards the latter end of the year. They go on growing and producing fresh flowers till Christmas. The stems are in the form of long irregular erect cones, and when old are covered by the withered or ragged remains of the leaves; they are analogous to the pseudo-bulbs of other orchideæ, and to those horizontal tuberous rhizomata, which in some species of this genus yield a kind of salep. *Bot. Reg.* 1972.

ZYGOPETALUM COCHLEARE. Shell-lipped Zygopetalum. This is a very distinct and handsome species of Zygopetalum. Pseudo-bulbs none; the leaves are from eight inches to a foot long; from the axil of one of the outer leaves arises the scape, scarcely of the length of one's finger, erect, having two membranous sheathing bracteas on the top at the base of the germen. Sepals and petals in our series, oblong, pale, greenish-white, spreading, combined at the base: the petals rather smaller than the sepals. Lip very large, nearly square, set on by a small short claw, very broad and cordate at the base, where it is ventricose, the sides involute and crisped, the apex reflexed, two lobed: at the base within is a large, lunate, fleshy, depressed crest, lobed and crenated, marked with purple lines, as is the lower half of the lip itself; but these lines soon combine, and form a large purple blotch in the upper half of the lip. Column short, semiterete, with two small wings above, with the front delicately streaked with red. *Bot. Mag.* 3585.

THE LILY TRIBE (ASPHODELEÆ).

CALLIPRORA LUTEA. Yellow Calliprora. An exceedingly pretty bulbous plant with yellow flowers. It is considered hardy by Dr. Lindley, but in Scotland Sir W. J. Hooker states it to be necessary to keep it in a pot in a frame, where it expands its pretty flowers in July. *Bot. Mag.* 3588.



THIS PAGE IS LOCKED TO FREE MEMBERS
Purchase full membership to immediately unlock this page



Never be without a book!

Forgotten Books Full Membership gives universal access to 797,885 books from our apps and website, across all your devices: tablet, phone, e-reader, laptop and desktop computer

A library in your pocket for \$8.99/month

Continue

*Fair usage policy applies

species of *Malva*; it is now in flower at Mr. Knight's, and merits a situation in every collection.

MESSRS. LODDIGES', Hackney. *Oncidium ornithorynchum*. This, though probably not a new plant, is at present very rare in our collections; the flowers are of a beautiful rosy pink colour, and are put forth on short slender branching stems; when in flower they have a very neat and elegant appearance, and it is certainly a most beautiful feature in this already extensive and extending genus. *Phajus albus*. This is a new and very excellent species of *Phajus*; the flowers are produced on a stem eighteen inches high, are large and white, with a lip of a beautiful purple colour; a fine plant of it is now in flower in the collection of the above gentlemen. Messrs. Loddiges have likewise a new orchideous plant now in flower, which strikingly assimilates in habit to *Cyrtochilum flavescens*; the flowers are very much like those of *Eulophia (Zygopetalum) cochleata*, and are produced in a similar manner; the lip (*labellum*) of the flower is of a fine purple colour, and almost equal in size and beauty to the lip of *Cattleya labiata*; it is certainly a most splendid plant, and will no doubt prove a highly valuable one. They have also a new and highly curious species of *Bolbophyllum* now in flower, which they have recently imported from Manilla; it is decidedly superior to any species of this interesting genus with which we have been previously acquainted, both in the size and beauty of its singular flowers; these are produced at the extremity of the flower stalk, and so disposed all round the stem as to form (when fully expanded) quite a flat surface; added to this, it possesses all the irritability and sensitiveness which are so distinguishable in *B. barbigerum*, and which render it such an object of interest to the lover of *Orchideæ*, so that by touching the lip of the flower a rocking motion is produced exactly similar to that of *B. barbigerum*.

MR. LOW'S, Clapton. *Chysis aurea*. This new and beautiful orchideous plant, which was first introduced to this nursery, is now flowering in great perfection there, and both on account of its singular habits, and the great beauty of its flowers, no collection of orchideæ should be destitute of it, particularly as it is a very free flowering plant. *Spiræa Japonica*. This is a new and very interesting species of *Spiræa*, of herbaceous habits; the flowers are white, and are produced very freely, and contrasted with the deep green and shining foliage, have a very neat and pretty appearance; it is without doubt a plant of great merits, and one of which no collection should be wanting. It has recently flowered in great perfection at the above nursery.

MESSRS. ROLLISON'S, Tooting. *Zygopetalum maxillare*. This, though not new, is without doubt one of the most beautiful species of this peculiarly interesting genus; the deep and brilliant blue colour of its labellum, contrasted with the bright green and chocolate colour of the sepals, added to the length of time it remains in flower, and the great profusion of flowers it bears, render it one of the most delightful objects of which the orchideæ house can boast, and entitle it to a prominent place in every collection. It is now exhibiting its beautiful blossoms in great perfection at the above nursery. *Cattleya crispa*. A remarkably fine specimen of this charming species is also now flowering with great freedom at this nursery, and it is certainly a feature of great importance in a collection of orchideæ. Messrs. Rollison's fine specimen of *Oncidium Lanceanum*, which attracted so much

attention when in flower last season, and of which Dr. Lindley justly observes, that "this plant is the most perfect instance of successful cultivation he has ever yet witnessed among epiphytes," has now perfected three fine spikes for flower, and we should think the flowers will expand in about a week; it will doubtless be a most magnificent object when in flower. *Verbena pulchella alba*. This is a beautiful variety of *V. pulchella*, with white flowers, and is admirably adapted for planting out in beds in the flower garden, as it spreads out its long trailing branches in all directions, and grows very rapidly and luxuriantly; it likewise flowers very abundantly, and is, when in flower, highly fragrant. A fine bed of it is now beautifully in flower at the before named nursery, and makes a beautiful contrast with *V. chamædrifolia*, &c.

MR. YOUNG'S, Epsom. *Delphinium Barlowii*. This new and extremely beautiful species of *Delphinium* is now flowering in great perfection at this nursery; the intense and striking brilliancy of its charming blue flowers defies all description, and completely dazzles the eye of the beholder when the sun is shining upon it; added to this it is a most profuse flowerer, and continues in flower during the whole of the summer season; these characters combined render it one of the best and most truly valuable herbaceous plants that have appeared in our collections for some time. *Chelone centranthifolia*. This is another rare and very handsome hardy herbaceous plant, possessing the habits of a *Penstemon*; it has been introduced to this country for several years, but (owing we suppose to the great difficulty there is in preserving it through the winter) it is yet very rare; however, it is a plant of great merits, and forms a most delightful feature in a collection of hardy herbaceous plants, or, if kept in a pot in the greenhouse, it will have a very pretty appearance, although it will not grow so luxuriantly. A very fine specimen of it is now most beautifully in flower at the Epsom nursery. *Anagallis Phillipsii*. This is a new species of this pretty genus, with flowers of a most brilliant blue colour, and very similar to those of *A. monelli*, but nearly twice as large; it is admirably adapted for forming beds in a flower garden, and is now delightfully in flower at the before named nursery. *Clintonia pulchella*. This is certainly one of the most elegant little annuals we have seen for some time, and appears likely to become an universal favourite; it is now flowering most profusely at Mr. Young's, and we refer our readers to the commencement of this number, where they will find a drawing of it; we think that it needs no other recommendation than to be seen. *Penstemon Murrayanus*. This splendid plant, which, from the brilliant scarlet colour of its flowers, claims a decided superiority over all other known species of this genus, is now producing its beautiful blossoms very abundantly on a fine specimen in the possession of Mr. Young; we should recommend our readers who possess plants of it (and who would willingly be without it?) not to keep them in a pot, but to plant them out into the open border, as plants that are treated according to the latter method will attain nearly twice the size of those that are confined in a pot, and, not only this, but they are very liable to damp and die off if kept in a pot; it seems, like *P. Cobæa*, likely still to remain very scarce, as scarcely one in twenty of the seeds preserved last year germinated this year; this is probably owing to the plant flowering too late in the season to get the seeds properly matured; besides this, its extreme liability

to damp off in the winter, will render it still more scarce ; at any rate there can be no better system pursued than that of planting it out in the open ground in summer, as it will thus grow very luxuriantly, and a great abundance of flowers may be thus ensured. *Verbena Tweedieana*. Probably some of our readers may not be aware that this lovely species of *Verbena*, though it naturally appears to be of erect habits, and will, if planted in a pot, grow perfectly erect, yet, if planted out in a bed in the flower garden, possesses all the habits of *V. chamædrifolia*, and will trail along the ground so as, if planted at nine inches, or even one foot from each other, completely to cover the bed on which it is planted ; this renders it, if possible, doubly valuable ; and as, when in flower, its fine bold heads of flowers protruded themselves full three inches above the level of the bed, it would be difficult to imagine a more interesting and attractive sight than a bed of it in full flower presents to the view of the beholder ; particularly as the heads of the flowers are nearly twice as large as those of *V. chamædrifolia*, and by being a greater distance from the ground, show themselves to much better advantage. We cordially recommend this species to all our readers as one of the most elegant and ornamental plants that has appeared for some time, and as one of the brightest embellishments which the flower garden can possess. In company with the above the *V. Drummondii* should also find a place, as its pretty pink blossoms will form a fine contrast to those of the one just noticed, and, to add to this, the flowers are most deliciously fragrant ; it may be treated in a similar manner to *V. Tweedieana*.

OPERATIONS FOR AUGUST.

CEROPEGIA ELEGANS BULBOSA may now be propagated ; they strike without difficulty in sand under a glass in a little heat.

CHRYSANTHEMUMS. The flowers of these plants will be much larger, and the display in the whole much superior in November if an additional shift is given some time this month ; the soil should be rich, and indeed the plants will progress better if a free supply of manure water is given regularly from the period of potting up to the time of flowering.

CREEPERS of all descriptions, whether under glass or in the open air, should now be attended to ; nail or tie in the majority of the wandering shoots in preference to cutting them off, for it is better to prune and thin in the spring when the leaves are off and the quality of the wood can be examined.

EVERGREENS may be pruned at this season, as May roses for forcing.

MIGNONETTE. This month is proper for sowing a few pots of Mignonette ; sown now and preserved through the winter in a frame, the plants come up early in spring.

PELARGONIUMS (GERANIUMS). Put in a supply of cuttings of the best kinds of this now very fashionable plant, they are simply propagated in sandy soil in a cool frame ; favourites of any species or other variety of greenhouse plants may now be successfully increased.

VERBENA TWEEDIEANA. A good number of plants should be propagated as soon as possible for the flower-garden next spring ; they strike very readily in any common soil without heat : by layers also a plentiful supply may be speedily secured.



THIS PAGE IS LOCKED TO FREE MEMBERS

Purchase full membership to immediately unlock this page

DELVE INTO FANTASY, MAGIC, MYTHOLOGY & FOLKLORE

Forgotten Books'
Full Membership gives
access to 797,885 ancient
and modern, fiction and
non-fiction books.

Continue

*Fair usage policy applies



ONCIDIUM LANCEANUM.

(MR. LANCE'S ONCIDUM.)

CLASS.
GYNANDRIA.ORDER
MONANDRIA.NATURAL ORDER.
ORCHIDEÆ.

GENERIC CHARACTER.—See Vol. IV., page 77.

SPECIFIC CHARACTER.—*Epiphyte*. *Leaves* fleshy, oblong, acuminate; greenish, irregularly marked on both sides with dark spots; in addition to which are more faintly seen pale longitudinal streaks interrupted by little spots of the same colour. *Scape* stiff, arising from the base of the inside of the leaf, twelve to sixteen inches in length. *Flowers*, racemose. *Sepals* fleshy, oblong, obtuse, the margins undulated, the middle a bright yellow, irregularly blotched with crimson, combining near the base. *Petals* similar to the sepals. *Lip*, a bright rich violet, the lobe or lower half somewhat darker, lengthened at the base on each side into an angular tooth; in the centre of the base are situated three tubercles, these terminate a ridge near the column which graduates downwards until it finally disappears at the terminating extremity; a little above the base it is narrow, when it breaks out again into a thin pale blunt extremity. The column on each side has an oblique rounded appendage, and is surmounted by a crimson anther.

THIS charming *epiphyte* combines in its blossoms a good portion of the richness and beauty of some species of *Cattleya*, along with the handsome yellow or brown markings of many of the extensive genus *Oncidium*. In the lip we have equalled the exquisite richness and delicacy of the petals of *Cattleya labiata*, while the sepals possess, in their pretty blotchings of brown and yellow, the beauty of *O. crispum*, *luridum*, &c. Added to these, it diffuses a most delightful fragrance, which Dr. Lindley resembles to the spicy odours of that sweetest of all flowers *Ærides cornutum*.

For its introduction we are wholly indebted to the liberality of John Henry Lance, Esq., who in 1834 brought plants from Surinam, which he presented to the London Horticultural Society, in whose collection of *Epiphytes* its handsome blossoms were shortly after produced. It has since flowered most splendidly in the rich collection of Earl Fitzwilliam, at Wentworth, Loddige's, Rollison's, Knight's, &c. The plant from which our drawing was taken, was grown by Messrs. Rollison, at Tooting, and is described by Lindley as the most splendid specimen he had seen.

It is by no means difficult to cultivate, as it thrives well in the *Orchideæ* house

with the usual treatment given to other species of the genus, viz. sandy peat and loam mixed with reduced potsherds or rotten wood. Watering it is most particular to guard against, as the plants are very liable to be much injured if allowed to get over wet at the root. A portion of the root with a leaf attached is generally sufficient to form a new plant; this, when detached from its parent, should be carefully potted, observing in doing this not to put it too deep in the soil, as it is very likely to cause the growing bud to damp: it is also especially necessary to avoid wetting the bud in this dangerous state during the process of watering. The bud will push better and sooner if the pot be placed on a warm flue.

The plant in a flowerless state is easily recognised from any of the other species, by the greenish yellow colour of the roots, and the spotted faintly striated leaves. Dr. Lindley has very justly named it in honour of Mr. Lance, who resided some time in Surinam. Previous to his bringing plants to this country Mr. L. has given the following account of its discovery, &c., which we borrow from the *Bot. Reg.* 1887. “ ‘ The first specimen of this splendid Epiphyte I discovered, was growing on the trunk of a large *Tamarind* tree, in a noble avenue of those trees close to the Government House in Surinam. I took it home with me and planted it in a pot filled with rotten pieces of wood and a little light earth; but though it remained alive and flowered once or twice, it did not thrive, but wasted away and became less. I afterwards found a great number of plants in different parts of the colony; they were generally attached to the stems or branches of the *Tamarind*, the *Sapodilla*, or the *Calabash* trees, appearing to prefer those to any other; however, on being tied to the branches of the *Orange*, the *Soursop*, the *Mammees*, and even the *Brugmansia arborea*, it grew well upon any of them and produced vigorous stems, with upwards of twenty blossoms on each stem. The scent is extremely fragrant, and is retained after the flower is dried, only becoming fainter and more of a spicy flavour than when fresh. The plant remains in full beauty ten or twelve days, a long period in that climate; and I found that it always required a shady situation and a living stem to grow upon, without which it would not produce its flowers in the highest perfection.’ ”



THIS PAGE IS LOCKED TO FREE MEMBERS
Purchase full membership to immediately unlock this page



Never be without a book!

Forgotten Books Full Membership gives universal access to 797,885 books from our apps and website, across all your devices: tablet, phone, e-reader, laptop and desktop computer

A library in your pocket for \$8.99/month

Continue

*Fair usage policy applies



Pedicularis stauropbyllum.



THIS PAGE IS LOCKED TO FREE MEMBERS

Purchase full membership to immediately unlock this page

DELVE INTO FANTASY, MAGIC, MYTHOLOGY & FOLKLORE

Forgotten Books'
Full Membership gives
access to 797,885 ancient
and modern, fiction and
non-fiction books.

Continue

*Fair usage policy applies



Mimulus Harrisonia.



THIS PAGE IS LOCKED TO FREE MEMBERS
Purchase full membership to immediately unlock this page



Never be without a book!

Forgotten Books Full Membership gives universal access to 797,885 books from our apps and website, across all your devices: tablet, phone, e-reader, laptop and desktop computer

A library in your pocket for \$8.99/month

Continue

*Fair usage policy applies

MIMULUS HARRISONIA.

(HARRISON'S MIMULUS.)

CLASS.
DIDYNAMIA.ORDER.
ANGIOSPERMIA.NATURAL ORDER.
SCROPHULARINÆ.

THIS showy hybrid is the result of impregnation between *M. cardinalis* and *M. roseus*, it having been obtained from seeds of the latter, the flowers of which were impregnated with the pollen of the former; in habit and general appearance it approximates more nearly to the former, while the flowers differ from it in the petals not being reflexed, and the colour being very similar to that of the mother species, *M. roseus*, which is of a beautiful rose colour: the plant evidently partakes of the nature of both the parent species, but the habit of it is far superior to *M. roseus*, while the flowers expand better, and are of a much more showy nature than those of *M. cardinalis*. These circumstances combined, constitute it at once a new and distinct species, and one which we have no doubt possesses sufficient merits to render it a truly desirable plant in any collection.

It was raised in the nursery of Messrs. Low and Co., Clapton, where it attained the height of three feet, and flowered most profusely in the month of June last, at which time our drawing was taken.

For culture, propagation, &c., see ample directions in Vol. I. pages 29, 54, 79; and Vol. III. page 198.

There can be little doubt but that this, like its parent *M. cardinalis*, will prove perfectly hardy, as experience has shown that this latter endures the open air through the winter extremely well, with exactly the same treatment as a common herbaceous plant; and it will certainly make a most delightful ornament to the flower-garden during the summer months.





THIS PAGE IS LOCKED TO FREE MEMBERS

Purchase full membership to immediately unlock this page

DELVE INTO FANTASY, MAGIC, MYTHOLOGY & FOLKLORE

Forgotten Books'
Full Membership gives
access to 797,885 ancient
and modern, fiction and
non-fiction books.

Continue

*Fair usage policy applies

beauty of the plant, but so impair the action of the functions of the leaves as to require much time and attention to recover them, which cannot be done at all without considerable loss of foliage. Cuttings are found difficult to strike, but if taken off when the wood is not too ripe, and planted in clean white sand, in a moderate bottom heat under a glass, carefully guarding against damp, they may be brought to make roots, but the readiest and at the same time the most effectual way of increasing it is by layering the young shoots in the common way; after the part layered is pegged securely down, it is a good thing, in order to facilitate and secure their rooting, to shake a little sand round the cut where the roots are to spring from, as it tends greatly to assist in healing the wound and nourishing the young rootlets: the old wood is too hard to be made available for either layers or cuttings. The following very interesting account of this useful plant, as well as that of the nutmeg below, we find in the Library of Entertaining Knowledge, both of which, as they contain much that is useful, we extract verbatim:—



Myrtus pimenta, or All-spice.

“ *Myrtus pimenta* is an extremely handsome tree, native of South America and the West Indies, especially of the island of Jamaica, whence the berries or pimento of commerce are exported in large quantities. This tree grows to the height of about thirty feet, with a smooth brown trunk and shining green leaves, resembling those of the bay; branches coming out on all sides, are clothed in the most luxuriant

foliage. In the months of July and August a profusion of white flowers pleasingly contrast with the dark green leaves, the whole forming an object of vegetable beauty rarely surpassed; while the rich perfume which is exhaled around, and which is wafted by the gentlest breeze, renders an assemblage of these trees one of the most delicious plantations of even a tropical clime. When the leaves are bruised, they emit a fine aromatic odour as powerful as that of the fruit; indeed it is said that they yield by distillation a delicate oil, which is often used in the dispensaries as a substitute for oil of cloves.

“The pimento tree grows spontaneously in many parts of Jamaica; it abounds more particularly on the north side of that island, in elevated spots near the coast. When a new plantation of these is to be formed, no regular planting or sowing takes place; it is usual to appropriate a piece of land either in the neighbourhood of a plantation already formed, or in a part of the woodlands where these trees are scattered in a native state. The land is then cleared of all wood but these trees, which are left standing, and the felled timber is allowed to remain where it falls to decay and perish. In the course of a year young pimento plants are found springing up on all parts of the land; produced, it is supposed, in consequence of the ripe berries having been scattered there by the birds, while the prostrate trees protect and shade the tender seedlings. At the end of two years the land is thoroughly cleared, only those plants being left which promise a vigorous growth; these come to maturity in about seven years from the first formation of the plantation, and usually attain to the height of thirty feet. But though apparently of so easy propagation, it is only in those parts where the tree is of spontaneous production. Edwards observes, that ‘this tree is purely a child of nature, and seems to mock all the labours of man in his endeavours to extend or improve its growth; not one attempt in fifty to propagate the young plants or to raise them from the seeds, in parts of the country where it is not found growing spontaneously, having succeeded.’ The tree was introduced into this country in the early part of last century, but the fruit does not ripen. It is delicate and difficult to manage, requiring at the same time warmth and a great deal of air.

“The flowers scarcely fade and give place to the berries ere these are fit for gathering; since if the fruit be suffered to ripen on the tree, it loses its pungency and becomes valueless. While yet green, therefore, the berries are carefully picked by hand; one person on the tree gathers the small branches; and three others, usually women and children, find full employment in picking the berries from these. The produce is then spread out on terraced floors, and exposed to the action of the solar heat for about a week; in the course of this time the berries lose their green hue, and become of a reddish brown. When perfectly dry, they are in a fit state for exportation.

“In a favourable season the pimento crop is enormous: ‘A single tree has been known to yield one hundred and fifty pounds of raw fruit, or one hundred weight of the dried spice, there being commonly a loss in weight of about one-third in curing.’ This return is not, however, of very usual occurrence, as the produce is variable; a

very plentiful harvest seldom occurring above once in five years. Pimento combines the flavour and properties of many of the oriental spices, hence its popular name.’”

On the *Myristica moschata*, True Nutmeg.—The treatment of this plant is but little known amongst cultivators in this country, in consequence perhaps of there being but few plants existing in our collections. A plant in His Grace the Duke of Devonshire’s collection at Chatsworth is treated after the following manner:—The soil used is a mixture of light loam or light loam and peat, to which is added a little sand; in this compost it grows strong, always maintaining a healthy appearance, and in the spring, when other stove plants are potted, it receives additional pot-room. In potting we take care to use plenty of drainage, and as much as possible to avoid over shifting; shortly after potting, the plant commences growing,



Myristica Moschata, or Nutmeg.

when it requires a good quantity of water, which, if the pot be well drained, passes through without injury, but in the autumn and winter we find it best to give but little, merely sufficient to keep the soil only just moist. It is, like the preceding, subject to the attacks of thrips, &c., which can be only effectually and conveniently guarded off by frequent and powerful syringing. When the leaves and wood are growing, and consequently tender, the plant must not by any means be exposed to the hot mid-day sun, as it is likely to become much injured and rendered very unsightly the whole season. It is very difficult of propagation, cuttings from the half-ripened wood should be planted in sand, covered with a glass, and plunged in a gentle heat, amongst saw-dust, observing to use every means to keep down the damp; carefully layered and a little sand placed about the wounds, as recommended for the species above, is a ready and successful method of obtaining young plants. The plant, when well grown, is very handsome, attaining, it is stated, in its native country as much as thirty feet in height, of an upright growth; the leaves are oblong-acute, of a lucid texture, and quite smooth. The flowers are deficient in beauty, being of a simple whitish-green colour, and rather wanting in show. It belongs to the Linnæan class *Diacia*, and order *monadelphia*, and to *Myristicæ* (Nutmeg tribe), of the natural system.

The succeeding very instructive hints on *Myristica Moschata* we quote from the Library of Entertaining Knowledge:—

“The Nutmeg—*Myristica moschata*—is a native of the Moluccas; and after the possession of these islands by the Dutch, was, like the clove, jealously made an object of strict monopoly. Actuated by this narrow-minded policy, the Dutch



THIS PAGE IS LOCKED TO FREE MEMBERS
Purchase full membership to immediately unlock this page



Never be without a book!

Forgotten Books Full Membership gives universal access to 797,885 books from our apps and website, across all your devices: tablet, phone, e-reader, laptop and desktop computer

A library in your pocket for \$8.99/month

Continue

*Fair usage policy applies

In general, the more brilliant its hue the better its quality. This is laid to dry in the shade for a short space; but if dried too much, a great part of its flavour is lost by evaporation, while it is also more apt to break in packing. On the other hand, if packed too moist, it either ferments or breeds worms. After being dried, it is packed in bags and pressed together very tightly.

“ *The nutmeg.*—The shell is larger and harder than that of a filbert, and could not in the state it was gathered, be broken without injuring the nut. On that account the nuts are successively dried in the sun and then by fire heat, till the kernel shrinks so much as to rattle in the shell, which is then easily broken. After this, the nuts are three times soaked in sea-water and lime; they are then laid in a heap, where they heat, and get rid of their superfluous moisture by evaporation. This process is pursued to preserve the substance and flavour of the nut, as well as to destroy its vegetable power. Dry lime is the best package for nutmegs.

“ There are two varieties, the royal and the green. The royal is the largest, and it produces mace longer than the nut; on the nut of the green the mace reaches only half way down. A good nutmeg should be large, round, and heavy, of a light grey colour, and finely marbled in the cross section.

“ Oil of nutmegs is obtained by pressure from the broken kernels; a pound of them generally yields three ounces of oil. According to Muman’s experiments, the oil produced is one third of the weight of nutmeg; it is yellow, of the consistence of tallow, and of a pleasant smell. This is a fixed oil, but a transparent volatile oil may likewise be obtained by distillation, in the proportion of $\frac{1}{3\frac{1}{2}}$ part of weight of nutmeg used.

“ There are other spices natives of the Moluccas, the principal of these are Massoy bark, and a species of cinnamon or cassia; but these, though much used in Chinese and Japanese cookery, are of inferior consequence, and nearly confined to the commerce of the East.”

ADVANTAGES OF STRIKING CUTTINGS IN WATER.

THE following remarks have been communicated to us by an amateur experimentalist, upon the correctness of which reliance may be placed.

Gardeners in general despise, or affect to despise, a mode of propagating a great variety of herbaceous and woody plants, which, however, (in instances too numerous to be detailed,) is eminently successful, and attended with circumstances highly interesting to the philosophic mind: this shall now be described.

It has long been known that *Nerium oleander* will emit roots in water, provided the cutting be of a proper age, and the temperature of the water be raised to about 70 degrees, either by keeping the vessel in a warm room exposed to the sun’s rays, or by plunging it into a warm bed of leaves, tan, &c.; with such certainty is the end attained, that in this one instance regular gardeners comply with the practice, but there they stop.

The idea suggested by the fact above stated, led to the following observations and results:—

First, as concerns *Oleander*. The vessel in which the cutting is to be placed, should be a phial of white glass, with a neck the orifice of which is at least three quarters of an inch, to permit of the removal of the plant without much pressure on the newly-formed roots: this vessel should contain water sufficient to receive one inch or more of the lower extremity of the cutting, and the water should be kept to that quantity.

Second. The cutting ought to be of green wood, and taken off during the full growing season of spring and summer; for such cuttings in water succeed best, and never flag under the power of a hot sun. If winter or autumnal propagation be attempted, it will be better to adopt the ordinary method with mould or sand; and in either case it will be always worth while to take some of the cuttings, which show the germs of future blossoms; as it will not unfrequently happen that very pretty little plants may be formed, which will expand their blossoms in perfection with the first growth of the future wood. This has been mentioned in a former article on *Nerium*.

Third. Though water be efficient in exciting radical developments, it will not support the plant for any considerable period; and it was proved, by direct experiment, that it was vain to expect any good result from the introduction of manuring substances into the fluid: even a little moss dropped into a phial, containing a well rooted healthy cutting, produced an almost immediate change. The roots lost their clear white colour, became yellow, weak, and flaccid; and the plant perished in the course of little more than a week.

The foregoing observations will convey some idea of the general principles of water culture; but there are particular exceptions, which cannot fail to attract the attention of any person of quick discernment. Thus, for instance, the beautiful *Erythrinæ* (*Crista-galli*, and *Laurifolia*, the very young spring shoots of which will take root in water) exhibit very interesting phænomena.

After remaining some days without any apparent change, a slight enlargement of the lower end of the cutting takes place, brilliantly white granulations of a species of cellular matter, closely resembling light pith of elder, form at and round the base, but do not adhere to it; many masses detach themselves, and fall to the bottom of the water, or, it may be, float in it; gradually these masses increase, the bark cracks into longitudinal fissures, more parenchymatous substance emerges, and at length becomes truly organised; and then tubular and fibrous roots appear about the base, and at the fissures. The plants, when so prepared, may with safety be transferred to any light soil, than which none appears to be so extensively congenial as that pure *sandy heath-mould* (not *peat* of the turbarry), which formerly was known by the term of *bog-earth*. Another example of water striking is the *Dahlia*. To persons accustomed to excite this fashionable floral beauty, it will appear superfluous to try an auxiliary mode of propagation. But these remarks are not intended for florists, or trading exhibitors; they are offered to the consideration of those enquiring minds, who are ever on the alert to acquire a glimpse of the simple yet ever mysterious powers of nature.

The fact that the young shoots of the *Dahlia* would emit perfect roots in water, was elicited by an accident which may very easily befall any amateur, who

possesses merely a few roots of the plants. Some half-dozen roots, which appeared in good condition at the commencement of the late spring, were placed on a little heap of loose earth, on the floor of a vinery, which was at work in forcing a set of vines in pots. It was thought that the gentle heat would stimulate the embryos sufficiently; and that the progress of growth could thus be daily observed.

The experiment was not fully successful, and some shoots fell a sacrifice to slugs; so that it appeared most prudent, as the season was far advanced, to plant the roots at once into the open ground. Four of them produced good shoots, one was very weak, and the sixth was exhausted. To supply the loss three cuttings of the strongest were taken off below the third or fourth joint, and put into the same bottle, which was placed on a shelf of the stove, close to a side light facing the south-west sun. During ten days little change occurred, but at length the lower ends of each cutting enlarged, the bark opened in fissures much resembling those of a vine where aërial roots are protruded, pithy adhesive substance filled up each crack, and from this fibrous processes now emerge—for the experiment is at this moment in progress.

Balsams propagate freely in water, by cuttings of any size whatever; but in no vegetable production is the advantage to be derived from the process more evident than in the families of the melon tribe. Plants may be formed in a very short period (sometimes in three days); and being transferred to small pots of heath mould, will produce perfect balls of roots in less than a week.

In like manner experience has shown that *Gloxinias*, and *Gesneria*, *Heliotropium Peruvianum*, *Aloysia citriodora*, *Petunia*, *Alonsoas*, *Salvias*, *Turnera trioniflora*, *Thunbergia*, *Melastoma cærulea*, *Gardenia florida*, with many other stove and greenhouse plants, can be propagated. *Brunsfelsia* has not been tried, but the texture of its young shoots, about the middle of July, leads to the idea of a successful issue; the season which heretofore has proved most favourable is the hottest period of summer, *i. e.* from the middle of June to the end of August.

The practice is, however, still in its infancy; and thus a mere outline of its first principles can be traced.

“But,” says the professional man, “*cui bono*—to what does all this tend? cuttings may indeed be converted into plants by the agency of pure rain water, or that obtained from ponds, rivers, or deep wells, which last abounds with salts of lime; but they may be and are successfully treated in the ordinary routine of striking.”—True! this is admitted: but in that ordinary routine numbers are lost: they do not take to the soil, or damp off and perish, after having excited hopes of success for months; and all the changes are produced—*sub umbra—in the dark*. In water, if the plant succeed at all, it never droops; the operation is performed in a minute, and little anxiety results from the situation in which the vessel is placed. The progress of every development is discernible; and the operator contemplates with admiration the phenomena produced by the co-existent decomposition and absorption of water, under the stimulus of solar light above and radiated heat from beneath, when the vessel is plunged in a hot-bed

The gardener becomes a philosopher; he sees before him proofs of vital action



THIS PAGE IS LOCKED TO FREE MEMBERS

Purchase full membership to immediately unlock this page

DELVE INTO FANTASY, MAGIC, MYTHOLOGY & FOLKLORE

Forgotten Books'
Full Membership gives
access to 797,885 ancient
and modern, fiction and
non-fiction books.

Continue

*Fair usage policy applies

UPON THE SUPPOSED ABSORBENT POWERS OF THE CELLULAR POINTS, OR SPONGIOLES, OF THE ROOTS OF TREES, AND OTHER PLANTS.

BY THOMAS ANDREW KNIGHT, ESQ., F.R.S. *

AN opinion is very extensively, if not generally, entertained, that the nutriment which trees and other plants derive from the soil in which they grow, is exclusively taken in by the cellular extremities of their roots, which, from their texture, have been called spongioles; and which, in their organisation, differ from other parts of the root in being totally without any alburnum or woody matter distinct from the bark. But it is through the alburnum alone of trees, as I have proved by a great variety of experiments, and as is, I believe, generally admitted, that the ascending sap, under ordinary circumstances, passes up from their roots into their branches and leaves; and as this substance does not exist in the spongiole, my attention was directed to an inquiry whether the spongioles possess the power of transmitting fluids, and, if such power were found to exist in them, through what peculiar channels such fluids pass up: and as these questions are necessarily interesting, and to some extent, in particular cases, may become important to the practical gardener, I communicate the result of my experiments.

Spongioles are obtainable in the most perfect state from large seeds, - such as those of the common or French bean, which have been permitted to germinate by simply detaching them from the cotyledons; as they thus remain united to the caudex of the plant, and its bud and plumule. Many of these were obtained from the seeds of plants of several kinds, and subjected to various modes of treatment in soils of different qualities; but all perished without a single plumule having expanded, or having apparently received any nutriment, either from the soil or other source. Yet the spongioles, in these cases, must have contained greatly more living organizable matter, derived from their cotyledons, than the whole body of the seed of a very large majority of plants can possibly contain: but they were, I conclude, incapable of transmitting it into the plumules, owing to the want of alburnum.

I therefore believe my opinion, that spongioles are imperfectly organized parts of the plant, which neither absorb from the soil nor transmit fluids of any kind for the service of other parts of it, to be well founded; but alburnous matter is generated with great rapidity within them; and they become to a very great extent transmuted into perfect roots long before the growth of the stem or branches of the tree commences in the spring, and by these newly formed roots (but not by these exclusively) I conceive that nutriment is absorbed from the soil and sent up into the leaves, to be there converted into the true sap of the plant. I am aware that the above stated opinions are in opposition to those of many eminent physiologists, to which much deference is due: but I think that they have erroneously included within their spongioles portions of alburnous fibre, a substance never found in the organ properly called a spongiole.

* Read before the Horticultural Society, May 17, 1836.

REMARKS ON FUEL.

WE quitted this subject at page 58 of the present volume, by observing that some species of ashes are extremely useful as ameliorators of heavy soil ; this is true to such an extent, that we have seen a gentleman's garden, not remote from us, where the land was naturally so binding, that it could scarcely be worked with the spade, effectually cured by it. The gardener has been twenty years with his employer, and assured us of the facts which came under his own immediate observation. He succeeded in bringing the ground to its present open and fertile condition, by the application of sea-coal ashes only ; they were put on the surface of the beds and borders freely, and digged in : the practice was persisted in, as the material could be obtained from the vinery furnaces, &c., and the soil remains perfectly good. The reader will recollect that ashes are not decomposable to any great extent ; they contain three or four earths, and particularly much *flinty matter*, with oxide of iron. *Decomposable manures* meliorate, but their effects are fugacious, because they are, for the major part, convertible into water and several gases ; the earthy residua (of which there is a certain quantity) being, by the processes of chemical attraction under the stimulus of vegetable life, assimilated with the native soil. This is a mysterious phenomenon, but it is of every-day occurrence ; and thus it is, that manures are finally (as far as concerns these earthy deposits) converted into earth of a quality corresponding with that of the ground in which they are deposited.

By some, the above remarks may be deemed inapplicable ; but it is hoped that any philosophical fact, which is connected as a link with other facts under consideration, must be pertinent, and therefore worthy of being recorded.

In our last article, we enumerated the various sorts of fuel which would most commonly be met with ; it remains to point out the economic use. Gardeners in great places will not, it is probable, pay any attention to our observations ; but there are amateurs, and young beginners, who may derive some pleasure, as well as instruction, from the report of experience.

By referring to the number for August 1836, p. 157, the reader will find a description of the *cellular wall*. This mode of building will prove economical in more ways than one, because it interposes a stratum of air between the bricks ; and this, if the furnace or furnaces be properly situated, will be, in a degree, warmed by the action of the fire, and thus come in aid of the flue ; for, though the walls may not be sensibly warm to the touch, certain it is that if a sheet of air, say thirty feet in length and eight feet in height, receive and communicate but three degrees of additional temperature from a heated surface, it will retain it for a considerable period. Again, the wall on the south side of the house receives the solar ray, and thus another warm stratum of air is created. The cellular wall is therefore, we maintain, a *sine qua non* in buildings where economy forms part of the projector's plan. But the direct results of the action of fuel must be derived from the proper construction of the fines. We believe that in vinerias (and these, if worked well, are excellent winter flower-houses before the vines are excited) the flue ought to

range the entire length, and run two courses, the one *over* or on the *pot* of the other, and not side by side. In this case it should enter at one end (say the west) from the extreme corner of the back wall, pass under the floor, and rise into the house at a point about one-third of its breadth within the front wall; it will then proceed to the east end of the house, return *upon* itself, and pass off at the west end, to a chimney over the furnace. Some like a double course, the first to run along and near the front wall; the *return* to be abreast of, and within, the first, and both on the floor. We believe that the draught of the fire (a great point) and the equable distribution of heat, are favoured by the single flue first described, which stands considerably within the front wall, and presents a deep surface of heated masonry. To secure the draught, the neck of the furnace must rise considerably. Some contract this neck, to give a rush of air; but the depth of the fire-place below the level of the horizontal flue is the secret of success. The fire grate ought to be from two feet to thirty inches below the floor, or lower brick of the flue, and the neck must rise so much, ere it deliver its flame and smoke into the first flue. The grate ought to be cast in one piece, with a solid plate of iron five inches wide in front of the bars; and these need not be more than twelve or fourteen inches long. A grate so constructed, contains the ignited fuel in the part open to the ash pit, the solid plate next the door being destined to receive the cold fuel, which thus is gradually acted upon by the hot iron pan below, and by the heat reflected from the brick-work above it, till it give forth a stream of gas, which passing over the burning mass beyond it, becomes inflamed, and raises a very great heat. Thus a well-constructed furnace is partially a smoke consumer, and much volatile matter (which would inevitably be lost in air if the coals were thrown on the burning mass) is converted into the medium of extreme diffusible heat.

If the house be narrow, with a steep roof, and double flues be more convenient, it will be prudent to build the furnace about the middle of the back wall, exactly under it, so that the whole of the fire be within the limits of the house. Then, provided the furnace be sufficiently sunk, the fire will throw much heat into the cells, which will expand itself throughout the entire range.

The neck of the furnace will slope gradually till it delivers itself at the distance perhaps of four feet from the inner surface of the wall, into the nearer of the two flues. In a house thirty-six feet long, if the fire enter at one end, turn at the other by the course of the inner flue, and deliver its smoke into a chimney over the furnace, the heat will be distributed unequally; and in the event of windy nights, a very large fire will hardly maintain 56 degrees of Fahrenheit. To remedy this defect, it is proposed to divide the inner flue, at the point where the furnace flue enters it, into two courses, formed by means of an acute projecting angle of brick-work, so as to give a double course to the flue; one to the left or east, and the other to the right or west. Each of these courses is to be furnished with a smoke-tight damper, by which the fire may be made to act in either direction, or in both at once, as it will occasionally do under certain circumstances. However this may be, if the weather be severe, the damper to the left should at first be opened, and the course of the smoke will then be to the east; and thence, by the front course, it



THIS PAGE IS LOCKED TO FREE MEMBERS
Purchase full membership to immediately unlock this page



Never be without a book!

Forgotten Books Full Membership gives universal access to 797,885 books from our apps and website, across all your devices: tablet, phone, e-reader, laptop and desktop computer

A library in your pocket for \$8.99/month

Continue

*Fair usage policy applies

NEW AND RARE PLANTS,

FIGURED IN THE LEADING BOTANICAL PERIODICALS FOR AUGUST.

CLASS I.—PLANTS WITH TWO COTYLEDONS (DICOTYLEDONEÆ).

THE BEAR TRIBE (LEGUMINOSÆ).

HOSACKIA STOLONIFERA. Creeping-rooted Hosackia. Seeds of this hardy herbaceous plant were sent from California, by Mr. D. Douglas, among the last that were received from him. It forms an interesting addition to the genus Hosackia. It is much larger than any other known species, forming a stout bush about three feet high, and multiplying itself readily by its creeping roots. Although its flowers are unattractive, it forms a good shrubby plant, where it is desirable to form the appearance of undergrowth quickly, for it resembles a shrub during the summer, and it spreads so fast as soon to extend far beyond its original station. It flowers in June, and produces an abundance of its seeds in August. *Bot. Reg.* 1977.

LUPINUS VERSICOLOR. Party-coloured Lupinus. This is a beautiful perennial Lupin, introduced from California, by the Horticultural Society. Dr. Lindley says, "the decumbent habit of this species renders it well suited for a bed in a flower-garden; it produces a great profusion of its pale, many-coloured flowers, breathing the sweet perfume of the field bean, during all the months of May and June; after which it ripens its pods, and remains shabby for the rest of the year." *Bot. Reg.* 1979.

THE ERICA TRIBE (ERICACEÆ).

RHODODENDRON ARBOREUM; var. CINNAMOMEUM. Cinnamon-coloured Tree Rhododendron. This is a most beautiful and interesting hybrid Rhododendron, the flowers are nearly white, prettily spotted, and make a large head, being very numerous and thickly set. The seed from which it was raised was sent to England by Dr. Wallich, through the Honourable Court of Directors of the East India Company; it flowered in the nursery of Messrs. Rollison, of Tooting, in April last. Mr. Herbert informs me, adds Dr. Lindley, that the old white variety of *R. arboreum* is hardy, and has stood 12 or 13 years in the garden at Spofforth, the present hybrid may, therefore, be expected to possess the same quality. *Bot. Reg.* 1982.

PRIMULA TRIBE (PRIMULACEÆ).

PRIMULA VENUSTA. PURPLE AURICULA. This is a pretty species, with leaves in form like the common *auricula*, but altogether smaller; the flowers are also much smaller, of a dark purple colour, with a lively light coloured eye, and very pretty. It is found wild upon the hilly parts of Hungary, about Hladnik, and also about Mount Baldo. *Bot. Reg.* 1983.

PHILADELPHÆ.

DEUTZIA SCABRA. Rough-leaved Deutzia. An erect branching shrub four or five feet high, with the whole of the young parts rough with minute starry pubescency. It forms an elegant shrub, a native of Japan and China, and introduced from the latter country a few years ago by Mr. Reeves, to whom our gardens are indebted for many equally interesting plants from the same quarter. It is of easy culture, being sufficiently hardy to endure our winters in the open air, and easily increased both by cuttings and layers. During the early part of summer it is covered with a profusion of white flowers, which are highly fragrant. *Brit. Fl. Gar.* 393.

THE POPPY TRIBE (PAPAVERACEÆ).

PLATYSTEMON CALIFORNICUS. Californian Platystemon. A hardy annual, of considerable beauty, with straw-coloured flowers, and hairy green leaves; it grows in any light loamy soil, and is readily increased by seeds, which it perfects freely in the open border. *Brit. Fl. Gar.* 394.

CLASS II.—PLANTS WITH ONE COTYLEDON (MONOCOTYLEDONEÆ).

THE LILY TRIBE (LILACEÆ.)

ORNITHOGALUM LATIFOLIUM. Broad-leaved Ornithogalum. This is a good and very desirable species; the petals when fully expanded are quite white on both sides, never having the decided green line found in most ornithogalums. It is quite hardy, and flowers in April and May. *Bot. Reg.* 1978.

THE ORCHIS TRIBE (ORCHIDEÆ).

DIPODIUM PUNCTATUM. Dotted Dipodium. A most curious, leafless, terrestrial orchidaceous plant, with thick fleshy fibrous roots, and purple spotted flowers. It flowered at Messrs. Loddiges', and is a native of New Holland and Van Diemen's Land, but is rather rare in the latter island. Mr. Allan Cunningham met with it in sandy forest ground in the colony of Port Jackson, and beyond the Blue Mountains, flowering in December. *Bot. Reg.* 1980.

NEW AND RARE PLANTS

IN FLOWER IN THE LEADING NURSERIES AND PRIVATE GARDENS IN
THE VICINITY OF LONDON.

MESSRS. HENDERSON'S, Pine-Apple Place. *Nolana atriplicifolia.* This is, without doubt, one of the most beautiful annuals we have seen for some time, and is admirably adapted for forming beds in the flower-garden; as, on account of its trailing habits, it will very soon cover the surface of the ground; and the great size and peculiar beauty of its flowers (which bear so striking a resemblance to

those of *Convolvulus minor*) renders it a most desirable and interesting feature in any collection. *Lupinus Cruikshankii*. This is, according to Sir W. J. Hooker, a shrubby species of *Lupinus*; and, though not new, yet perhaps is the most elegant species of this extensive genus at present known to our collections, and no person who possesses a taste for floriculture should be destitute of it. *Campanula Scheuchzeri*. A somewhat rare species of this interesting genus, with large blue expanding flowers, and rather dwarf habits, is now flowering most profusely. The whole of the above, together with some very fine species of *Lilium*, viz. *L. superbum*, *Canadense*, *candidum*, &c., are now flowering in a high state of perfection in the nursery of Messrs. Henderson; and they have also many very interesting *Alpine* plants now in flower.

MR. KNIGHT'S, Chelsea. *Drymonium bicolor*. This is a new stove-plant of much interest; the genus appears to be nearly allied to *Sinningia*, and the flowers are very similar in size and shape to those of *Sinningia villosa*; they are of a greenish yellow colour, slightly spotted with brown, and the inside of the tube of the corolla is very hairy; the foliage is smooth and of a deep green; the plant is shrubby, and of such a climbing habit, that it throws out long roots or feelers all the way up the stem, especially on the young wood; these attach themselves to the wall against which it is trained, in a similar manner to those of the common ivy; this renders it a desirable plant for training against the wall of a stove, more particularly as it is a remarkably free grower. *Gloriosa superba*. A very fine specimen of this magnificent plant is now flowering most profusely in the stove of the above named nursery, and forms one of the brightest ornaments of the stove at present known to our collections. Amongst the *Orchideæ*, several fine specimens of various species of *Stanhopea*, as well as others which are less beautiful, are now flowering in great perfection. *Nuttalia grandiflora*. This is a new and extremely beautiful herbaceous plant, and is now producing its fine purple-coloured blossoms very abundantly at the above nursery.

MESSRS. LODDIGES', Hackney. *Cycnoches ventricosum*. This is a new, or at least a rare, species of *Cycnoches*, and with the exception of its having flowered in the collection of J. Bateman, Esq., of Knypersley, we are not aware that it has ever before flowered in this country; it bears a striking resemblance to *C. Loddigesii* in general appearance, but differs from it in the flowers being of a pale green colour. It is certainly more curious than beautiful, but is highly deserving of a place in every collection. *Vanda tessellata* or *Roxburghi*. These two species approximate so closely in many respects, that it is almost difficult to say which of the two it is that is now so beautifully in flower at Messrs. Loddiges'; but, judging from the time of flowering, and knowing that *V. Roxburghi* usually flowers much later in the season, we should think that the present subject is *V. tessellatum*; however, it is a plant of considerable merits, and one of which no collection should be destitute. We are happy to inform our readers, that those two immense specimens of *Testudinaria elephantipes*, which we some time ago had occasion to notice, are growing most vigorously, and are without doubt the finest at present in the country.

MR. LOW'S, Clapton. *Fuchsia Atkinsoniana*. This is, we believe, a new species



THIS PAGE IS LOCKED TO FREE MEMBERS

Purchase full membership to immediately unlock this page

DELVE INTO FANTASY, MAGIC, MYTHOLOGY & FOLKLORE

Forgotten Books'
Full Membership gives
access to 797,885 ancient
and modern, fiction and
non-fiction books.

Continue

*Fair usage policy applies

OPERATIONS FOR SEPTEMBER.

ANNUALS of various kinds may now be advantageously sown; they must be sown in small pots, as they will require a frame for protection during winter: so treated, they will flower early and well in spring.

BULBOUS PLANTS. The kinds that have done flowering should now be dried off; others, that are showing flower, should be introduced to the forcing-house.

CARNATIONS. Pinks, &c., propagated as directed last month, will now require potting off; they must have the protection of a frame in the winter, which must be set in a sheltered situation, and a floor of ashes laid within for the pots to stand upon to keep the roots dry. Seedlings planted out last month will be infested by slugs, &c.; these must therefore be guarded against.

CALCEOLARIAS may be successfully propagated from cuttings in the early part of this month. Cuttings struck last month should be potted as soon as possible.

CHIMONANTHUS FRAGRANS layered last month should now be examined, if rooted, detached from the parent, and in a few days removed altogether. Cuttings should also be potted off this month, and they will get established before the growing season closes. A few cuttings might be now put in with success.

GREENHOUSE PLANTS. Cuttings now put in will succeed.

MIGNONETTE. A little seed immediately sown will come in well before the main winter crop, the seed of which must be put in by the middle of this month.

ORANGE AND LEMON TREES, budded last month, must now be attended to.

ROCKETS, &c., cut down last month, will furnish a good stock of cuttings which may now be successfully put in; they take well in sandy soil; if a glass is placed over them they will root sooner.

VERBENA TWEEDIANA continue to propagate, also the other kinds should now be increased; they must be preserved in a frame or greenhouse through the winter: little water will suit them best, for if allowed to get wet for any length of time they are likely to damp. *Calceolarias, Petunias,* and other stock intended for the flower border next spring, will require the protection of a frame or greenhouse: they must have a liberal supply of air when the weather is favourable, and be kept close in cold windy, frosty, or rainy weather, observing to give the water with a cautious hand, and they will stand well, make good plants and flower freely in flower-garden borders next season.



H. Smith, del. et sculp.

Clematis carulea.

OCT 1837.



THIS PAGE IS LOCKED TO FREE MEMBERS
Purchase full membership to immediately unlock this page



Never be without a book!

Forgotten Books Full Membership gives universal access to 797,885 books from our apps and website, across all your devices: tablet, phone, e-reader, laptop and desktop computer

A library in your pocket for \$8.99/month

Continue

*Fair usage policy applies



CLEMATIS CÆRULEA.

(VIOLET CLEMATIS.)

CLASS.
POLYANDRIA.ORDER.
POLYGYNIA.NATURAL ORDER.
RANUNCULACEÆ.

GENERIC CHARACTER.—See Vol. IV., p. 147.

SPECIFIC CHARACTER.—A hardy climber. *Leaves* ternate. *Leaflets* ovate, acute, entire. *Flower-stalks* arising from the axils of the leaves, one-flowered. *Sepals* six, oblong, lanceolate, somewhat acute, membranous.

THIS beautiful and valuable creeper produces large violet flowers, with deep purple stamens, in great abundance from June till October, and sometimes even later. The plant has a very graceful mode of growth, and no doubt will prove a most valuable addition to our hardy climbers.

It is nearly related to *C. florida*, says Dr. Lindley, from which it differs not only in the colour, delicacy, and transparency of its blossoms, but also in its leaves being only once ternate, and in the sepals not touching and overlapping each other at the edges.

It is a native of Japan, from which country it was introduced by Dr. Von Siebold.

For culture and propagation, see page 147.



THIS PAGE IS LOCKED TO FREE MEMBERS

Purchase full membership to immediately unlock this page

DELVE INTO FANTASY, MAGIC, MYTHOLOGY & FOLKLORE

Forgotten Books'
Full Membership gives
access to 797,885 ancient
and modern, fiction and
non-fiction books.

Continue

*Fair usage policy applies

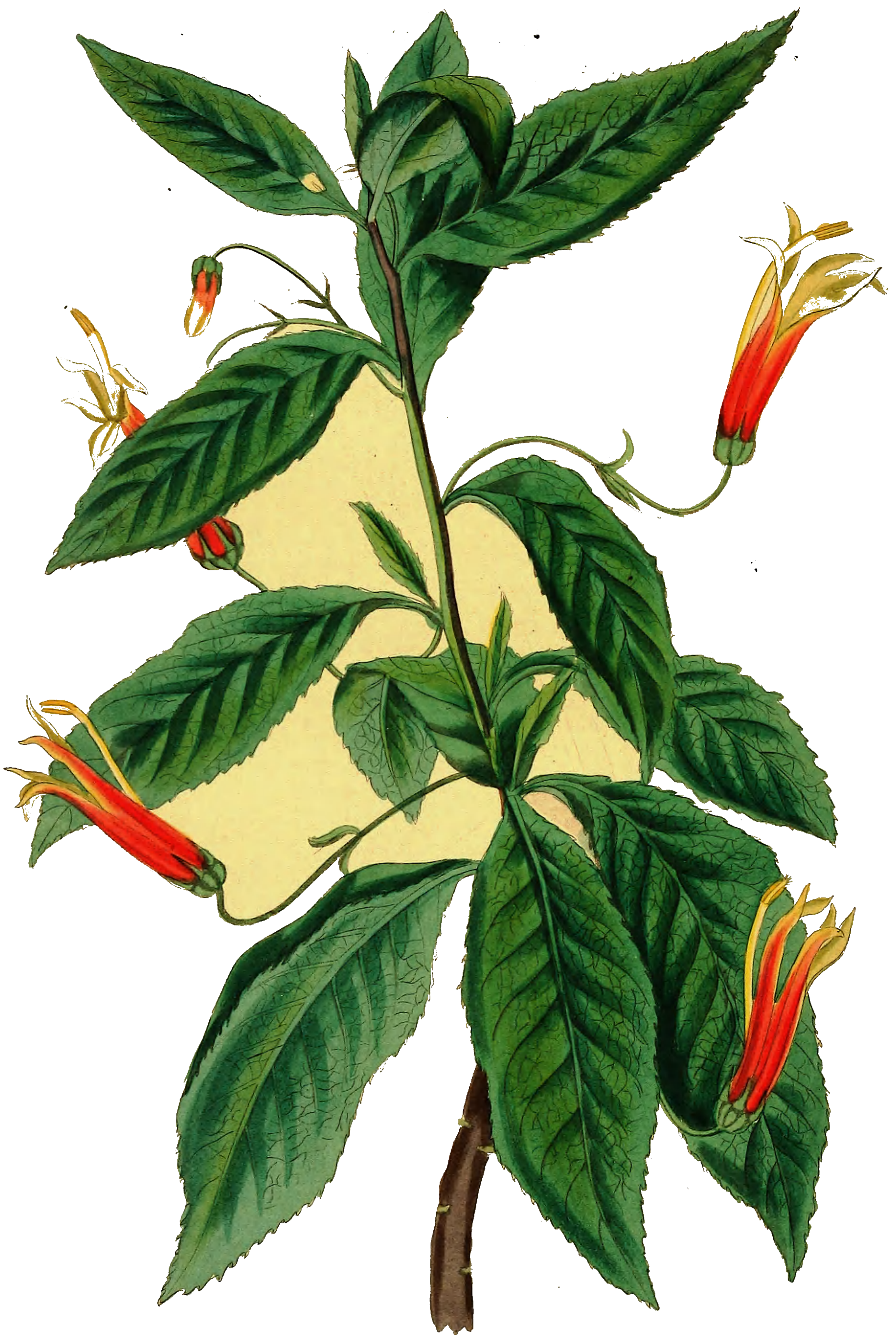

Siphocampylus bicolor.





THIS PAGE IS LOCKED TO FREE MEMBERS
Purchase full membership to immediately unlock this page



Never be without a book!

Forgotten Books Full Membership gives universal access to 797,885 books from our apps and website, across all your devices: tablet, phone, e-reader, laptop and desktop computer

A library in your pocket for \$8.99/month

Continue

*Fair usage policy applies



Acacia longifolia.

Acacia pulchella.



THIS PAGE IS LOCKED TO FREE MEMBERS

Purchase full membership to immediately unlock this page

DELVE INTO FANTASY, MAGIC, MYTHOLOGY & FOLKLORE

Forgotten Books'
Full Membership gives
access to 797,885 ancient
and modern, fiction and
non-fiction books.

Continue

*Fair usage policy applies

ACACIA LONGIFOLIA.

(LONG-LEAVED ACACIA.)

CLASS.
POLYGAMIA.ORDER.
MONŒCIA.NATURAL ORDER.
LEGUMINOSÆ.

GENERIC CHARACTER.—*Flowers* polygamous. *Calyx* four or five toothed. *Petals* four or five, sometimes free, and sometimes joined together into a four or five-cleft corolla. *Stamens* variable in number, from ten to two hundred in each flower. *Legume* continuous, dry, two-valved.

SPECIFIC CHARACTER.—*Phyllodia* (leaves) lanceolate, attenuated at both ends, two three-nerved at the base, and quite entire, the rest many-nerved. *Spikes* axillary, twin, on short peduncles. *Calyx* four-cleft.—*Don's System of Gard. and Botany*.

SYNONYME.—*Mimosa longiflora*. Andr. Bot. Rep. 107. *Mimosa macrostachya*. Poir, Suppl. 1. p. 61.

THIS very ornamental greenhouse plant is a native of New Holland, found plentifully on the east coast. It grows to a large size, sometimes as much as ten or fifteen feet high, and branched in proportion; a plant of even half that size when in full bloom is a most lovely object, for the spikes of flowers are generally very numerous, and being yellow they make an elegant contrast with the ample green pendant foliage. It is not so well adapted for a greenhouse, except the house be spacious and lofty, as for the conservatory, where it can be planted in a border, and plenty of room allowed for its roots to ramify and its branches to flourish. It grows best in open soil composed of strong loam and peat. It propagates easily from cuttings or from seeds.

The sample for the drawing was most kindly furnished by our esteemed friend Mr. Cameron, of the Birmingham Botanic Garden, a short time back.

This is a most interesting and beautiful genus of hardy greenhouse plants, producing their flowers for the greater part in the spring months, when comparatively few plants besides are in a state of flowering. No collection should be without the following species, all of which are very fine and beautiful flowerers, and of easy cultivation.

Acacia decipiens.	Acacia angustifolia.
— armata.	— limifolia.
— juniperina.	— verticillata.
- diffusa.	— — angusta.
· stricta.	· linearis.
— hispidula.	— mucronata.
· uncinata.	— longissima.
- taxifolia.	— longifolia.
— penninervis.	— pulchella.
— melanoxylo.	— lophantha.
· vestita.	— Lambertiana.
· lunata.	— pubescens.
— brevifolia.	— decurrens.
— suaveolens.	

ACACIA PULCHELLA.

(PRETTY ZIGZAG-SPINED ACACIA.)

GENERIC CHARACTER.—See preceding page.

SPECIFIC CHARACTER.—A pretty little and very distinct interesting greenhouse plant, growing about three and a half feet high. *Leaves* conjugately pinnate, and very numerous. *Flowers* solitary, forming a small round head, and arising from the axil of the leaf. *Spines* something shorter than the leaves, solitary, and rather stiff.

AN interesting and accurate account of this elegant little plant we find given in the Bot. Cab. page 212, in the following words:—"This beautiful little plant is from New South Wales, whence it was introduced about the year 1803. It produces its fragrant flowers in May and June in the greatest profusion, generally some at the axil of every leaf. The leaves are extremely delicate, and the whole plant forms a small prickly bush; it must be kept in the greenhouse in the winter, and will increase pretty well by cuttings; it flourishes in a loam and peat soil. The roots of this and of other acacias have an unpleasant smell, although the flowers are so odoriferous. What a curious property is this, that a plant should derive from the same nutriment qualities so opposite? but the more we examine the productions of the Almighty, the more shall we ever find that

‘ Wonderful indeed are all His works;
Pleasant to know, and worthiest to be all
Had in remembrance always with delight.’”

We saw a large specimen of this species in full flower in the greenhouse of the Royal Gardens at Kew in June last; it had a beautiful effect, for the little globular heads of yellow flowers contrasted so prettily with the neat delicate foliage. The scent was delightful. We deemed it a pretty feature among the other plants, and as it generally flowers well it doubtless should be in every collection.

Our drawing was made from a plant which flowered in the greenhouse at Chatsworth in June last.

The two species represented in the plate show the amazing difference in foliage of species of the same genus.



THIS PAGE IS LOCKED TO FREE MEMBERS
Purchase full membership to immediately unlock this page



Never be without a book!

Forgotten Books Full Membership gives universal access to 797,885 books from our apps and website, across all your devices: tablet, phone, e-reader, laptop and desktop computer

A library in your pocket for \$8.99/month

Continue

*Fair usage policy applies

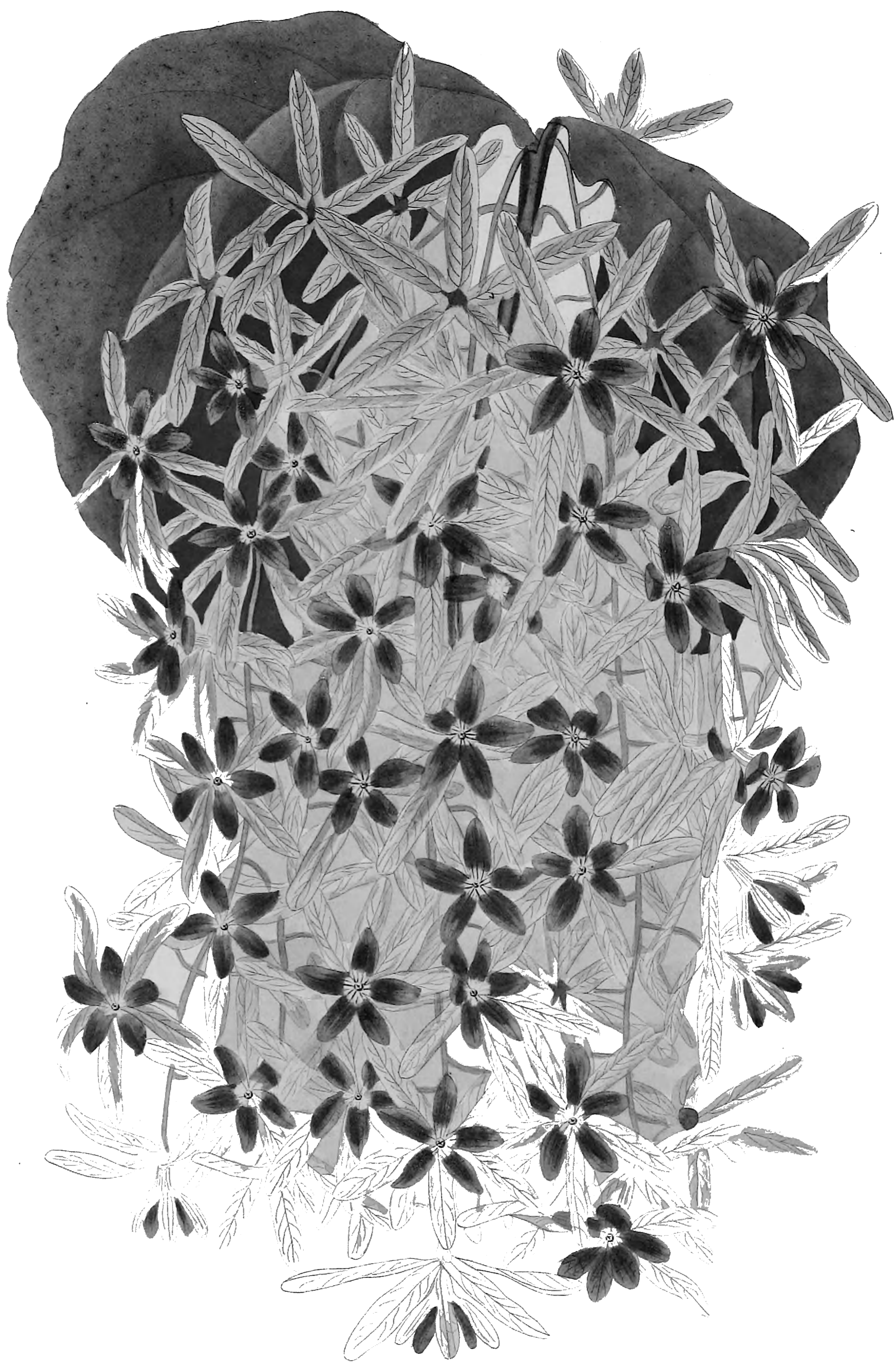

1837

OCT 1837

Petrea.







THIS PAGE IS LOCKED TO FREE MEMBERS

Purchase full membership to immediately unlock this page

DELVE INTO FANTASY, MAGIC, MYTHOLOGY & FOLKLORE

Forgotten Books'
Full Membership gives
access to 797,885 ancient
and modern, fiction and
non-fiction books.

Continue

*Fair usage policy applies

It delights in good open loam, mixed with a little sandy peat ; and cuttings in sand, under a glass, in heat, root freely. It must be kept constantly in the stove, where it thrives well, particularly if the situation be warm and moist ; when growing it takes a good deal of water, but in the autumn and winter it is necessary to be very cautious in the administration of this element, as the roots when over watered in winter do not start well when put into new soil in the spring ; the pots should be well drained.

The generic name is given in honour of Robert James Lord Petre, of whose death, which took place in 1742, Linnæus speaks as one of the greatest losses Botany or Gardening ever felt in this island.

HINTS ON THE CULTIVATION OF SOME SPECIES OF HEDYCHIUM.

EVERY collection of plants, embracing the cultivation of ornamental exotics, should contain some of the most beautiful species of this delightful genus. Indeed the whole Natural Order *Scitamineæ* does not contain one more worthy of the cultivator's care, or that produces, in such a high degree, flowers combining the two leading desiderata in the culture of plants, viz., beauty and sweetness. They are all reed-like plants with herbaceous stems, natives without exception of the East Indies, and in the hot-houses of this country of the simplest cultivation. In noticing this genus, it is my intention to point out the most successful mode of cultivating each species; to which will be added a few words on their peculiar merits, so far as my opportunities have enabled me to ascertain them.

I shall commence with the

H. coronarium; or, as it is so very appropriately named, the "Sweet-scented Garland flower." This species produces an immense number of its delightfully sweet and snow-white flowers from June till late in October; these appear in constant succession at the top of the strongest shoots from beneath the imbricated scales, composing a compact squamose oblong spike. In the house, whether a large or a small one, where this plant is flowering, the most delightful and grateful odours mix with the atmosphere, so that on entering the smell is so pleasant, that a degree of reluctance is experienced when thoughts of leaving are entertained. With my mode of cultivation I have proved eminently successful: it is as follows. I have already stated that the plants cease to perfect any flowers towards the latter end of October; at this time I place them any where at the back of the stove without reference to situation, for sometimes the light is nearly excluded; in a short time the leaves grow yellow, and the stems wither, when I cut them off within an inch of the base, leaving the plants in the same situation as before, where in fact they remain all winter, during which time I never suffer them to have any water. In the spring, say early in March, when the potting season begins to bear heavy upon the gardener's mind, I examine the *Hedychium coronarium*, and, if necessary, I take out some of the oldest rhizomas or under-ground stems, thus affording the remainder more space and freedom to push,—if it does not require thinning I set about potting it, as directed below, in the following compost—rich strong turfy sandy loam in the proportion of three to one of rotten dung or leaf mould; but the former I prefer, being stronger if well rotted, when it mixes nearly as well with the loam as decomposed leaves; or I have now and then thrown in a little peat instead of dung or leaf mould, but I always considered the plants to do better with dung. Whether or not the roots are parted, I always shake out a good part, if not the whole of the old soil, and plant the roots entirely in new compost, allotting to them such a sized pot as I find will be sufficient to enable them to support strong shoots, or in other words, to use the common term amongst gardeners, I always give a good or full shift. I invariably put two inches of coarse crocks for drainage at the bottom of each pot, upon which I lay an inch or so of rough turfy loam or dung; the latter I find very

serviceable, as the roots soon run to the bottom where they meet with something upon which to feed. I never give a second shift the same season, but, immediately after potting, I apply a good quantity of water, and in general remove the pot to the hot bark bed of a pinery, or other place where it can get a brisk bottom heat; soon after the application of bottom heat, the shoots begin to push freely and finely, when too much water can hardly be given. In this situation, thus treated, they stand until the flowers appear, when I remove them to the plant stove, which they greatly ornament with their white flowers and render it otherwise very pleasant by the diffusion of their grateful odours. The plant is not very subject to be attacked by insects, still it requires to be now and then syringed and watched; for if neglected for any length of time, the mealy bug I have found to appear under the spathe of the flower spike, and to increase in number so much as to become very unsightly and dirty. I am not aware of there being any means of propagation beside dividing the roots, by which young plants are readily obtained: the seed, I believe, never ripens in this country, a deficiency abundantly provided for by the facility of increasing them at the roots. A few flowers gathered with long stalks, and introduced into nosegays, impart a delightful fragrance; also the atmosphere of the sitting or drawing room is rendered exceedingly grateful and inviting by the introduction of merely half-a-dozen flowers; these should be renewed every morning by fresh ones from the plant, which, in general, affords a plentiful supply. It is said to be of Chinese origin, and is very much cultivated in the Malaccas on account of its exquisite odour, and is frequently worn by the Indian *belles* in their hair; and in the symbolical language of the Malays, when sent as a present to a young man, it is intended to reproach him for inconstancy in love.

Hedychium angustifolium, or Red Garland Flower, is a splendid species attaining as much as six feet in height, and producing at the top of the strong shoots a beautiful large cluster, a foot in length, of soft vermilion or scarlet flowers; these are delightfully fragrant, but much less so than the preceding species. It flowers in general late in July or the beginning of August, but does not keep up such a succession as the species *coronarium*, neither do the individual flowers remain perfect so long. This species I cultivate with the greatest success in the same manner as recommended for *H. coronarium*. The plants grow quite free and strong; the flowers are very numerous, and prove a desirable autumnal acquisition to the stove, or a corner of the pine pit, where I sometimes allow them to flower; and, indeed, in a working vinery they are highly ornamental and produce a tolerably good quantity of flowers, but a plant of this description is so much at variance with the harmonious appearance of the pinery or vinery, that it cannot be considered in its proper place out of the plant stove. This species was discovered by Roxburgh, on the coast of Coromandel, and by Dr. Buchanan, in Upper Nepal; and was introduced to this country by Sir A. Hume, about 1815. Propagated, as noticed above, for the preceding species.

Hedychium flavum, or Yellow Garland Flower. This fine species, we are informed by the Hortus Bengalensis, was sent by Mr. M. R. Smith, from Silhet, to the Calcutta garden, in 1810, whence it has lately been brought over to England, and flowered with us in December. The blossoms are very showy, and their fragrance is delightful, a little resembling a ripe orange, with a mixture of jasmine. The stem grew about four feet high.



THIS PAGE IS LOCKED TO FREE MEMBERS
Purchase full membership to immediately unlock this page



Never be without a book!

Forgotten Books Full Membership gives universal access to 797,885 books from our apps and website, across all your devices: tablet, phone, e-reader, laptop and desktop computer

A library in your pocket for \$8.99/month

Continue

*Fair usage policy applies

H. longifolium grows six feet high, and in June and July produces its red flowers ; also a native of the East Indies, and introduced into this country in 1823.

H. speciosum. This is a showy species, with delightfully scented pale yellow flowers ; it grows eight feet high ; flowers in August and September ; is a native of the East Indies, whence it was introduced in 1823.

H. maximum. This is a larger growing species, attaining the height of *H. speciosum*, and produces white flowers in August. Introduced in 1820.

H. villosum. A dwarf species, three feet high, with cream-coloured flowers. Introduced in 1823.

H. glaucum grows from four to five feet high, producing, in July and August, white flowers. Introduced in 1822.

H. ellipticum grows five feet high, producing white flowers from July to September. Introduced in 1804.

H. acuminatum attains the height of four feet, flowers white, appearing in June and August. Introduced in 1820.

H. spicatum is a dwarf-kind, producing yellow flowers in June. Introduced in 1810.

H. thyrsiforme. This is a handsome species, attaining the height of four feet, and produces an abundance of white flowers in July and August. Introduced in 1818.

The generic name *Hedychium* is compounded from *hedys*, sweet, and *chion*, snow ; from the true qualities of the flowers, viz. white and sweet.

CULTURE OF SPARMANNIA AFRICANA.

By E.

WE not unfrequently witness large specimens of this beautiful plant in a state of ill health, indicated by the dingy yellow colour of its leaves, and the contracted growth of the two or three preceding years' shoots, although the plant in general appears to have grown quite free before this diminution in growth became manifest. The want of luxuriance in this plant in the case now in hand is in my judgment attributable to two causes ; on the one hand, to confinement at the roots, which disposes the plant to produce a greater quantity of flowers than it can support, without robbing a considerable portion of the nutriment sent up by the rootlets ; and necessary for the completion of the usual growth in the branches ; and on the other, too poor compost, which induces the plant to throw out a quantity of stunted, half-sized, and half beautiful flowers, without affording the required strength to the branches. Whether or not this deficiency be referable to either of the causes I have pointed out I am not fully prepared to prove, but certain I am, that a good sized plant now under my eye grew and flowered remarkably well for the first four or five years of its growth, and was every spring greatly admired by all who saw it ; after this a decline in the growth of the wood, and luxuriance of the foliage, without any diminution in flowers, size excepted, took place, which rendered the plant unsightly instead of ornamental, for it always after looked sickly and offensive to the eye. In this state it stood two years ; I potted it as usual, but perceiving no im-

provement, I started an examination into the cause, which I commenced by turning the root-hall out of the tub, when, to my great surprise, I could not discover any defect in the roots, or want of strength in the soil; from which it appeared clear to me that the only means of restoring the health of my plant, must be by enlarging the tub, and reshifting it in quite new compost, comprising two parts of strong open turfy loam to one of unusually well decomposed dung carefully incorporated. This I did early in the spring of 1834, and I had last season the satisfaction of seeing my favourite plant in good health, clothed with a luxuriance of foliage such as I never expected to see gracing its noble head, and affording an ample background to its large umbels of nodding blossoms. The number of umbels this season I did not count, but there were a great number; and the white petals of each flower, with the purple tips resembling anthers, contrasted with its large cordate pendulous foliage, produced an appearance even more splendid than on former occasions; the plant now spoken of has generally stood in a rather light situation, and I am disposed to think, from what I see of the habits of some younger plants of this species, that they do best in a light situation. If I had not observed very particular caution in administering water to my old plant, I should have attributed its ill health at once to want of due attention in this respect, but I was well aware this could not be the case; indeed the healthy and clean condition of the roots convinced me at once to the contrary. I have not an indiscriminate mode of watering as is too often the case, but I water my plants as experience teaches me they want it, and I always endeavoured to keep the *Sparmannia* rather dry during winter, and watered it rather copiously during summer, and more particularly in the growing season. I also washed its branches now and then with clean water from the syringe, which kept it clean and free from insects. I propagate it in sand or sand and loam mixed with little trouble. The pot, after inserting the cuttings, I place under a hand-glass in a little bottom heat. I water them well at first, after which I do not, without they get very dry, give any more until rooted and ready for potting off, when I give a little; the young plants I bring on in a frame for a while, from which I harden them by degrees to the greenhouse. I give the young plants frequent shifts during summer, but principally in the spring, in the above compost. And they grow beautifully, and I have no doubt of their flowering splendidly in a season or two.

E.

At Chatsworth we find this plant to do well in an orangery, treated like the orange trees, except in potting or tubbing; when we vary the soil a little, using strong loam and peat in the proportion of two parts of the former to one of the latter. We have a plant fast declining in size of foliage and wood, in the manner described in the above article; we fancied the plant had been kept too cold, and at the same time perhaps over-watered, being an effect frequently resulting upon a variety of plants from similar combined causes. We hope however to bring it round by repotting, but shall not attempt this till spring. We are inclined to think, if we move the plant into a moderate heat after repotting, the success will be more certain. This plant is a native of the Cape of Good Hope; the generic name is in honour of Andrew Sparmann, M.D., a Swedish Botanist, who accompanied Captain Cook in his second voyage round the world in 1772—1775.

A DESIGN FOR A CAST-IRON GARDEN CHAIR.

AT page 257 of the last volume of this Magazine, we inserted a figure of a cast-iron garden chair, designed and sent us by our esteemed correspondent, Mr. Saul, of Lancaster, accompanied by a description. A short time ago we received the present novel design, which Mr. S. describes in the following words:—"I have been induced to design and execute another cast-iron garden seat of a light and attractive appearance, and at little expense, so that the lovers of gardening may have a commodious chair at a very trifling cost. The seat, which is supported by a little urn, is composed of a group of flowers, and the edge is formed of leaves. The top of the seat is about fifteen inches by twelve, quite light, and easy. The back of the seat represents a male figure; the right hand is so made, that a common umbrella may be placed therein, and removed with little trouble. The figure is holding, in each hand, a tin tube for holding water and cut flowers. At this season dahlias, and a few evergreens, have a striking appearance; indeed, flowers of different descriptions may be introduced nearly throughout the whole season; by this plan, the seat may be placed in any position, and removed at pleasure to any situation, as the person when seated is shaded from the sun by the umbrella, so that he has the full benefit of the refreshing breeze, mixed with the grateful fragrance from the different flowers. It has also a good and striking effect when placed near a tree. It may be readily conveyed to any part of the country without much trouble or expense."

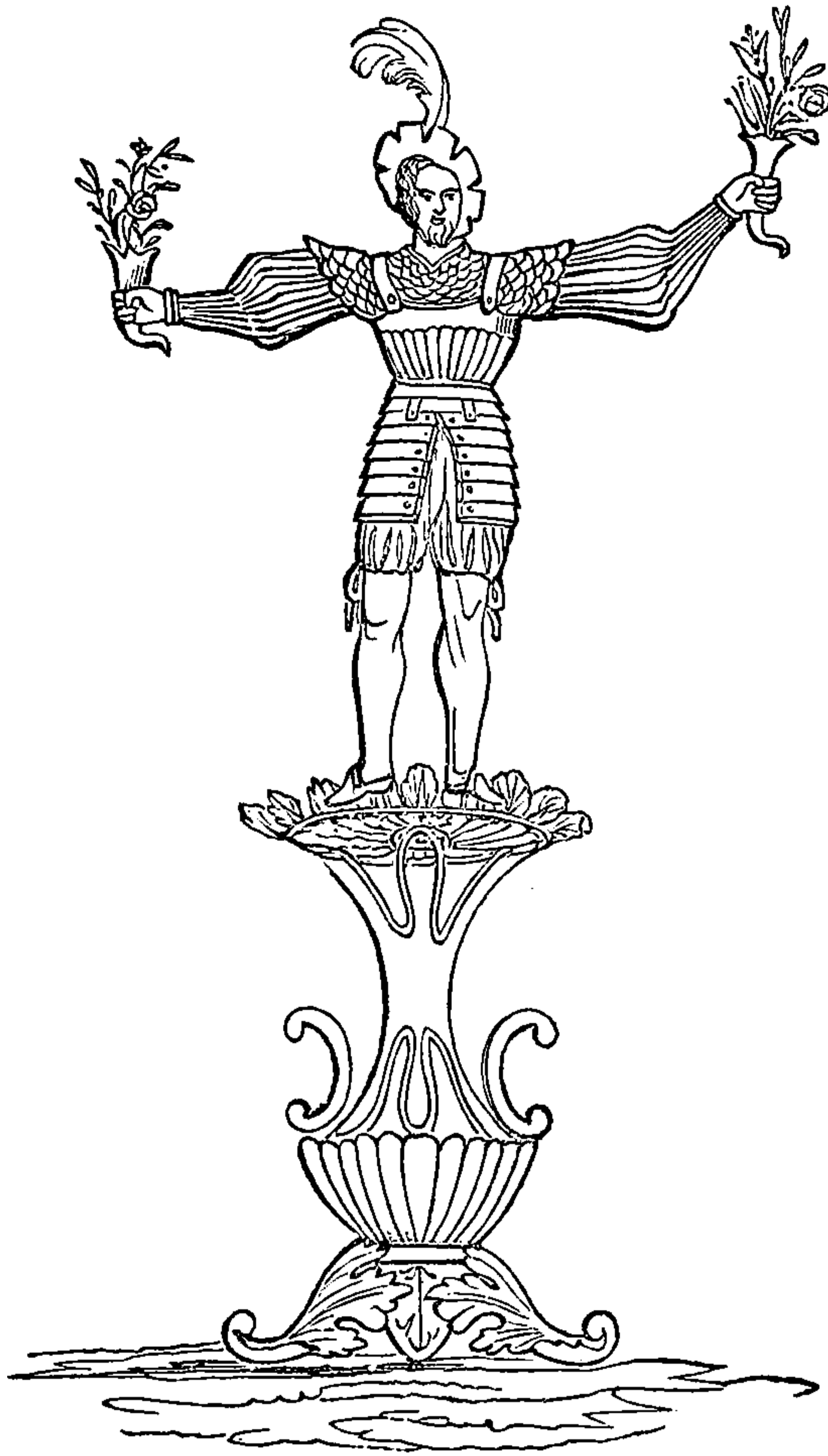



THIS PAGE IS LOCKED TO FREE MEMBERS

Purchase full membership to immediately unlock this page

DELVE INTO FANTASY, MAGIC, MYTHOLOGY & FOLKLORE

Forgotten Books'
Full Membership gives
access to 797,885 ancient
and modern, fiction and
non-fiction books.

Continue

*Fair usage policy applies

well to bear in mind that they do not require so much water as they would if more exposed; neither should they in any situation, but in this particularly, be left open to the direct influence of the sun: still let it be understood that they cannot have too much light. Plants such as these when very young are much better placed near the glass, but in this case it is necessary to watch against injuries from the sun, &c. In an evening, when the weather is fine, a little water sprinkled over the leaves will benefit them much, and if the pot has been well drained, a frequent repetition will not prove injurious. They are propagated with great difficulty from cuttings; the well ripened wood should be preferred, and the cuttings, when cleverly prepared, being cut neatly at the joint, should be planted in a pot of sand, placed under a glass in a close frame, pit, or greenhouse, but by no means plunged. The practice of searing the wounded part previous to putting in the cuttings has been advantageously practised, and in one particular merits attention as promising success in multiplying this desirable plant. It is by cutting the bark off the branch—through nearly—say a week or two before taking it off the plant; by this means the bleeding, which operates so much against the successful propagation of this plant, is lessened, and the wound, comparatively speaking, is healed, except the bit of bark that remains. The Chinese method of propagation, viz., ringing the branch, and placing a little good soil and moss round the wound, may be practised on this plant, and no doubt with great success.

ON RAISING NATIVE HYACINTHS.

THE plants which have flowered in glasses or pots produce better offsets than those raised in beds; these, together with the mother and now reduced bulb, plant at the usual season. The old bulb affords considerable nourishment to the young plants, which rise with great strength the following spring. When the leaves assume a yellow hue the plants are to be taken up, and replanted the same day in prepared beds; the stronger by themselves. The strongest plants will show blossoms the following spring, some of them having from twelve to twenty bells, or pips; these should be reduced to three or four, which should be left on the extremity to draw up the sap. Were the whole suffered to remain, the plant would be much exhausted in flowering; and if wholly taken off, it receives a great check. The bulbs are again to be taken up in October, and replanted as before, not permitting them to remain any time out of the ground. Moisture seems essential to the perfection of the hyacinth; and I find that those which remain in the ground, and of course subject to its influence, are not at any time affected with the ring disease, by which many of those which are placed in the stove are lost every season.

The compost best suited for them is, one barrowful of loam from rocky places, one ditto well rotted cow-dung. This should, if possible, be three years old; one third of a barrow of mould, produced from rotted tree-leaves, and about a fifth of a barrow from an old cucumber-bed. With this the bed is to be made two and a half feet deep, and the surface covered with turf-mould, to preserve the bulbs from frost.

NEW AND RARE PLANTS,

FIGURED IN THE LEADING BOTANICAL PERIODICALS FOR SEPTEMBER.

THE RANUNCULUS TRIBE (RANUNCULACEÆ).

DELPHINIUM INTERMEDIUM; *var. CÆRULESCENS*. A third and very striking variety of *Delphinium intermedium*, with very pale flowers, and tall stem. It has rather small flowers; its leaves and leaf-stalks are downy, especially the former on the under side, and there are many weak long hairs on the bracts and pedicles. These circumstances show how unimportant is the hairiness of the leaves, stem, and flowers, in this genus. *Bot. Reg.* 1984.

THE NIGHT-SHADE TRIBE (SOLANACEÆ).

GRABOWSKIA BOERHAAVIÆFOLIA. Boerhaavia-leaved Grabowskia. A spiny scrambling shrub, with singular fleshy, glaucous leaves, which give it a grey appearance, like *Atriplex Halimus*. It is hardy enough, in the garden of the Horticultural Society, to live out of doors against a south wall, where it does not suffer at all in modern winters; even in the last severe one it was not much injured. Notwithstanding the dull aspect of both leaves and flowers, it forms a pleasing appearance when mixed with others and greener plants. It is a native of Brazil, where Sellow found it in the fields and woods of the southern provinces, a common shrub growing from six to ten feet high. It is also found in Peru. *Bot. Reg.* 1985.

THE CONVULVULUS TRIBE (CONVOLVULACEÆ).

PHARBITIS DIVERSIFOLIA. Three-lobed Convolvulus Major. A very pretty little half-hardy annual, about half the size of the common *Convolvulus major*, of which it has very much the appearance. It differs, however, in constantly producing at the latter part of the year three-lobed leaves, instead of entire ones, so that specimens of the same plant, collected at different seasons, would be thought essentially different. In the first stage of its growth, it is like *P. hispida*, and at the next, it resembles *P. hederacea*, only that the calyx and inflorescence are distinct. A native of Mexico, whence seeds were obtained by Geo. F. Dickson, Esq. *Bot. Reg.* 1988.

THE DIANTHUS TRIBE (SILENACEÆ).

SILENE CHLORÆFOLIA. Armenian Catchfly. This is one of the neatest of all herbaceous plants in its broad, trim, firm, well-coloured leaves, and its compact manner of growth; the flowers are of the purest and brightest white, and are deliciously fragrant; it is quite hardy, if not exposed to a wet soil in winter; is easily increased both by seeds and cuttings, and thrives equally whether grown as a rock plant or in the common flower border. When grown upon rock-work, its flowers are only about half the size they acquire in a deep rich light soil. It was found in Armenia by Tournefort, and was introduced so long since as 1796, by Mr. Hunneman. *Bot. Reg.* 1989.

LOASEÆ.

BLUMENBACHIA MULTIFIDA. Multifid-leaved Blumenbachia. This is an interesting little plant, with yellowish-white pretty flowers, and handsome leaves. It is a much stronger growing plant than *Bl. insignis*, being more compact, more hispid, with stings; the leaves are much larger, five-partite in a palmate manner, the middle lobe the largest, but all of them bipinnatifid, and wrinkled upon the surface. *Bot. Mag.* 3599.

THE LOBELIA TRIBE (LOBELIACEÆ).

LOBELIA CAVANILLESII. Cavanilles' Lobelia. A very graceful and desirable stove-plant, a native of New Spain. The plant grows nearly three feet high, erect, scarcely branched, rounded, dark purple, clothed with scattered leaves, spreading in all directions and nearly horizontally, four to six inches long; sessile, lanceolate, glabrous, acuminate, acutely serrated for their whole length. The flowers are of a rich orange red, and very plentiful, one arising from the axilla of almost every leaf. It will grow well in light rich soil in the stove. *Bot. Mag.* 3600.

THE LOBELIA TRIBE (LOBELIACEÆ).

LOBELIA SIPHILITICA HYBRIDA. Hybrid variety of the blue American Lobelia. This is a most beautiful plant, the offspring of *L. siphilitica* on the one hand, and *L. splendens* or *fulgens*, or *cardinalis*, on the other. The foliage is most like the first, while the size and form of the flower chiefly resemble the three last; and the colour seems to partake of the red of the latter, combined with the blue of *L. siphilitica*, thus producing a rich purple hue, such as is very difficult to be imitated by the pencil of the artist. It is quite hardy, growing in the open air to the height of two or three feet, blossoming through the summer months, and continuing in great beauty till cut off by the autumnal frosts. *Bot. Mag.* 3604.

GESNERIACEÆ.

GESNERIA LINDLEYI. Dr. Lindley's Gesneria. This is a very striking plant, handsome in its foliage and in its flowers, which latter, though each is of few days' duration, are succeeded by others in the same whorl for a considerable length of time. It is a native of Brazil, and blossoms with us in the stove during the months of June and July. *Bot. Mag.* 3602.

THE OXALIS TRIBE (OXALIDEÆ).

OXALIS ALBA. White-flowered Wood-sorrel. This is a highly interesting species with pure white flowers, about the size of those of *O. Baueri*. The leaves are about as long as the scapes, erect, ternate, glabrous, green; leaflets cuneate at the base, deeply bipartite, with linear, blunt, divaricate, three-nerved lobes, two inches long, slightly revolute at the margins, and marked especially beneath with depressed dots. The drawing, communicated by Mr. James Macnab, was taken from a plant that flowered in the collection of Dr. Neill, of Edinburgh, in May last. The species is thought to be from America, from its near affinity to *O. bipartita* and *divergens*. *Brit. Fl. Gard.* 398.



THIS PAGE IS LOCKED TO FREE MEMBERS
Purchase full membership to immediately unlock this page



Never be without a book!

Forgotten Books Full Membership gives universal access to 797,885 books from our apps and website, across all your devices: tablet, phone, e-reader, laptop and desktop computer

A library in your pocket for \$8.99/month

Continue

*Fair usage policy applies

added to this, the petals are somewhat undulated at the edges, which gives it an air of gracefulness and elegance far superior to any other species with white flowers. Amongst the Orchideæ Mr. Knight has an apparently new species of *Camaridium*, the flowers of which are of a deep yellow colour, prettily spotted, and, though small, are by no means insignificant; it certainly merits a place among second-rate Orchideæ. He has also just received a quantity of Orchideæ from the island of Panay, as well as some from Rio Janeiro, amongst which will be found a few decidedly new and extremely curious species, which, if Mr. Knight succeeds in starting, will doubtless prove valuable.

MESSRS. LODDIGES, Hackney. *Miltonia spectabilis*. This truly beautiful and highly valuable Orchideous plant, which we have previously noticed in the August number of this Magazine, as nearly allied to *Cyrtochilum flavescens*, but which was then destitute of a name, has since received the above appellation from Dr. Lindley, in compliment to the family of the Earl of Fitzwilliam, for the zeal which that distinguished nobleman has displayed in the cultivation of this beautiful tribe; the plant certainly possesses considerable merits, and is every way calculated to perpetuate the name of the noble family before alluded to; it is now again flowering at the above-named nursery, and as this seems to prove that it is a profuse flowerer, we think no person who possesses a collection of this beautiful tribe, will willingly be long destitute of this splendid plant. Messrs. Loddiges have a curious stove plant which they have just imported from (we think) Demerara; from the size, shape, and disposition of the flowers (which are white), we should think that it is a species of *Asclepias*; it is evidently of a shrubby habit, and the present specimen is about a foot high; it is now growing in the manner in which it was introduced, that is, into a block of wood; but whether it is really a parasite, whether seeds of it may not have been accidentally or intentionally dropped into the piece of wood and thus generated in the soil which frequently accumulates in the hollows of old and decayed trees, or whether it has been placed in its present situation merely as a matter of experiment or curiosity, yet remains doubtful; we should think the latter has most probably been the case; at any rate it has a most interesting appearance, and is well worthy of any attention that may be devoted to it.

MR. LOW'S, Clapton. *Fuchsia globosa elegans*. This splendid variety (for a representation of which see the May number of this Magazine for the present year) is, without doubt, equalled by few and surpassed by none of the already numerous species and varieties of this genus at present existing in our collections; the size and brilliancy of the colour of its flowers are sufficient to recommend it to every lover of floriculture; it is now flowering beautifully at the above nursery. Mr. Low also possesses a very fine specimen of a species of *Anigozanthos*, which is considered new; it is however probable that the plant in question may prove to be *A. rufa*, but as we are not sufficiently acquainted with the latter species we cannot determine; it is a very ornamental plant, and flowers freely, and if new is certainly a valuable one. This nursery has recently received a valuable addition to its former stock, in a collection of Cacti and other succulent plants, which Mr. Low has imported: much might here be said to induce persons to cultivate this curious

and highly beautiful tribe of plants, as, in short, a collection of succulent plants seems almost an indispensable requisite to give to a good place its proper character and finish; for from the great and singular variety that these plants assume they cannot fail to excite the interest and admiration of the cultivator at all seasons of the year. Mr. Low has especially some very fine specimens of that remarkable plant *Cereus senilis*, or, as it is commonly called, "The Old-man Cactus."

MESSRS. ROLLISON'S, Tooting. *Maxillaria Rollisonii*. This is, we believe, a new species of *Maxillaria*, named in honour of Messrs. Rollison; it assimilates very much in habit to *M. stapelioides*; the flowers are small, cream-coloured, and beautifully spotted with red; it makes a very interesting addition to the species of this genus previously known, and is worthy of a place in every collection. *Oncidium leucochilum*. This beautiful species is again flowering most profusely at the above nursery, and recommends itself to the notice of every lover of Orchideæ. *Cistus speciosus*, an old but highly beautiful stove plant, is now flowering in great perfection at the above nursery, and is highly worthy of cultivation.

MR. YOUNG'S, Epsom. *Pentstemon gentianoides*. This beautiful species of *Pentstemon* is now producing its elegant blossoms in great perfection at this nursery; the flowers are of a fine purple colour externally, while the inside of the mouth of the corolla is white, beautifully spotted with purple; the foliage, though not so large as that of *P. Murrayanus*, is of a deeper green, and very handsome, and the plant being a very abundant flowerer, is truly interesting and valuable, and no collection should be without it. *Aconitum Chinense*. This is a new species of this extensive genus, and, we think, is the finest with which we are acquainted; the immense size and great beauty of its flowers, its remarkably fine foliage, and the habit it has of producing a fresh spike of flowers at the axil of every leaf, render it a most valuable addition to our stock of hardy herbaceous plants; no collection, however limited, should be destitute of it, as it is well adapted for any flower-garden purposes. *Liatris borealis*. This elegant new species of *Liatris* is now beautifully in flower at the above nursery; the flowers are produced in clusters, and are of a pretty pink colour; the plant is about two feet high, and when in flower has a very neat and interesting appearance. *Dianthus superbus, flore-pleno*. This is a most splendid variety, and is, we believe, new; the flowers are large, of the richest possible crimson colour, and are produced in great abundance, and a more beautiful object when in flower cannot well be imagined; it is now adorning the flower borders of the above nursery, and should be in the possession of every person who possesses a flower garden. Mr. Young has likewise a quantity of splendid specimens of *Pentstemon Murrayanus* now in flower, and we have nowhere seen such an excellent stock of this much admired species, as well as other beautiful species of this genus, as at this nursery. There is also a remarkably fine specimen of *Clematis Sieboldi* now flowering in a high state of perfection.

ON THE CULTURE OF NEW AND RARE PLANTS
IN THE LEADING NURSERIES AND PRIVATE GARDENS IN THE VICINITY OF
LONDON.

On the Culture of Lantana Selloi.

THIS interesting and beautiful little plant, though it has seldom, if ever, been noticed in any of the leading botanical periodicals of the day, and very little regarded by cultivators, seems to us to possess merits, which, if properly known and understood, would rescue it at once from the apparent oblivion into which it has sunk, and entitle it to a place in the best of collections. It not unfrequently happens, that when a plant (like the present) is first introduced to this country, it is cultivated in a much higher temperature than is really necessary for it, because persons are, in a measure, unacquainted with its habits. This has been precisely the case with the present plant, which, when it was first introduced, was treated as a stove exotic; this might readily be inferred from the circumstance that all the other species of the genus are stove plants, but experience has proved that this plant will endure the open air perfectly well in the summer months, and only requires the protection of a frame or greenhouse in winter. It is much to be lamented that many persons who receive or purchase new plants of the description of the one we are now noticing, cultivate them under the erroneous opinions before alluded to, for one or perhaps two years, merely for the sake of their novelty, and then, without ever investigating their true habits, or enquiring what further purposes of ornament they may be made to supply, they are by degrees discarded and lost sight of, till they become entirely lost to the collection. Thus it is that plants, which are in themselves truly beautiful, and which may be made to answer various ornamental purposes, are either for want of attention (having lost their novelty) wholly annihilated, or are thrown out of large establishments as unworthy of notice, and rescued only from total destruction by the amateur or cottager; so that we consider that any person who exerts himself to ascertain the true habits of plants, or what purposes they may be applied to, does a signal service to the science of floriculture. We are, however, happy to find that the subject of this article has not yet sunk so low, and, that it may not, we will just beg to lay before our readers an outline of the different modes of culture that it will submit to, which we have observed in the vicinity of London; and we trust that this, added to the beauty and elegance of its blossoms, will induce those who have not yet had it in their possession, at once to procure it, and those who have, to cultivate it more extensively.

The first method of treating this plant, we have before observed, was that of keeping it in the temperature of the stove; and, though we would condemn this practice while no other is admitted of, yet we cordially recommend it as one of those modes by which this plant may be made subservient to the wishes of the cultivator, and become an useful and valuable ornament. The first thing to be attended to is, necessarily, the work of propagation, and this should be performed by cuttings; for, though the plant may ripen seeds, propagation by cuttings is by far the most



THIS PAGE IS LOCKED TO FREE MEMBERS

Purchase full membership to immediately unlock this page

DELVE INTO FANTASY, MAGIC, MYTHOLOGY & FOLKLORE

Forgotten Books'
Full Membership gives
access to 797,885 ancient
and modern, fiction and
non-fiction books.

Continue

*Fair usage policy applies

OPERATIONS FOR OCTOBER.

THE beauty of our plant houses and flower-gardens is now beginning to indicate the approach of winter. The plants flowering in their greatest gaiety in the greenhouse, &c., have few successors for this season, and those splendid groups of scarlet and blue that appeared so gay and inviting in the flower-garden, and reflected such brilliancy under an autumnal sun, are beginning to fade, as if sensible of the approaching change.

GREENHOUSE.

GREENHOUSE plants that have been standing out during the summer season, are of course now introduced and made secure; give them plenty of air in fine weather, but be careful to keep the house close or nearly so during strong cold bleak winds, or catching frosts; the results of omissions in this respect very frequently injure the leaves after coming from the open air. At this season they should also be very carefully watered, and the stage, flue, paths, &c., should be kept dry, for damp in this and the three or four following months is often seriously injurious in plant houses. Pay especial and undeviating attention to young stock: neither let the soil get over dry or over wet; both are nearly alike injurious, but rather let them get dry than wet, for a little moisture may be more readily communicated than extracted.

Hyacinths and other bulbs may now be introduced; water glasses may also be brought into requisition towards the end of this month. The bulbs should be brought on in a little heat, and placed in the greenhouse or drawing room to flower; those intended to flower in the glasses, should be the finest and most promising.

FLOWER GARDEN.

PLANT anemones and border bulbs towards the end of this month; clean away decayed leaves and decaying stems of herbaceous plants, but preserve as many flowers as possible, and all green leaves, &c., in order that the beds may not appear destitute of foliage. Secure florists' flowers, such as auriculas and carnations, from dashing rains and strong winds; this may best be done by bending hoops with awning or mats stretched over them, or, where convenient, with small glass frames, &c. Collect seeds of all desirable kinds; dry and clean them properly, and they will be in a secure state for keeping till spring; to assist the memory, write the name legibly on the back of every packet.

COLD FRAMES, PITS, &c.

TENDER and half-hardy annuals in pots for early spring flowering, such as the *larkspurs*, *Adonis vernalis*, *stocks*, &c., should be introduced into the cold frame or pit, where a dry floor has previously been made with coal ashes, or old tan; indeed old dry tan is an excellent thing to plunge them in; give them abundance of air, but always keep the lights over the plants in wet or damp weather. Mignonette thus treated, will stand well. All young stock for the flower-garden next spring, such as *Verbenas*, *Anagallis*, *Salvias*, *Calceolarias*, &c., should be similarly kept and treated, observing to keep the plants rather near the glass. The various kinds of alpine plants should be removed to their winter quarters, and judiciously supplied with water and air.







THIS PAGE IS LOCKED TO FREE MEMBERS
Purchase full membership to immediately unlock this page



Never be without a book!

Forgotten Books Full Membership gives universal access to 797,885 books from our apps and website, across all your devices: tablet, phone, e-reader, laptop and desktop computer

A library in your pocket for \$8.99/month

Continue

*Fair usage policy applies

plant to decorate the flower-garden in the open air, there is scarcely any thing to be compared with this strikingly beautiful plant. A compost of equal parts of sandy heath mould, loam, and rotten leaves, suits it well, and an average temperature of from 45° to 65° causes it to flourish amazingly, but we have no doubt that it would do well in even a lower temperature. It requires plenty of water whilst growing, and frequent washings with the syringe; we omitted in the proper place to say that it flowers nearly all the year round, having been already in full perfection for six months, in which state it promises to remain a long time yet.

Our drawing was obligingly communicated by Messrs. Lucombe and Pince, in June last, having been previously taken by the skilful and accomplished artist Miss Morrish, from a full-grown plant, magnificently in flower in the Exeter Nursery. The flowers seem to commence opening about May and June.

The genus *Statice* is much prized on account of the many beautiful species it contains, some of which are amongst the most showy and prettiest of our hardy border flowers; of these we may particularly notice *S. speciosa* and *Tartarica* as being well adapted for planting near the edge of flower borders, in which situation they flower well and have a very gay appearance for a long time; the species are not common in our gardens, although they grow freely in any light sandy soil. They increase by divisions or by seeds. The following species are all handsome, and deserve to be cultivated in every collection:—

S. speciosa. Plantain-leaved Sea Lavender is an elegant plant, grows a foot high; flowers purple, very abundant, appearing about July and August. An excellent evergreen herbaceous plant, proper for the front of flower borders.

S. sinuata. Purple scalloped-leaved Sea Lavender is less handsome than the preceding; grows a foot high; flowers nearly white, and not abundant; appearing from May till September. An evergreen herbaceous plant, somewhat tender, succeeding best it has been said in the greenhouse in pots, where, as it is disposed to throw up new flowering stems, some plants will be in flower nearly all summer. The dried flowers look very pretty on the mantelpiece in winter.

S. spathulata. Spathula-leaved Sea Lavender is not very handsome, growing a foot high, and with its reddish flowers making a very interesting show in the flower border; quite hardy.

S. conspicua. Showy Sea Lavender is very ornamental; grows a foot high; flowers a lively pink, and very numerous. An evergreen herbaceous plant, preserved with difficulty, and in consequence is, like *speciosa*, rather scarce.

The species *alpina*, *denticulata*, *emarginata*, and *latifolia*, are ornamental, and worthy of a place in all collections.



Cineraria Waterhousiana.



THIS PAGE IS LOCKED TO FREE MEMBERS

Purchase full membership to immediately unlock this page

DELVE INTO FANTASY, MAGIC, MYTHOLOGY & FOLKLORE

Forgotten Books'
Full Membership gives
access to 797,885 ancient
and modern, fiction and
non-fiction books.

Continue

*Fair usage policy applies

CINERARIA WATERHOUSIANA.

(WATERHOUSE'S HYBRID CINERARIA.)

CLASS.
SYNGENESIA.ORDER.
SUPERFLUA.NATURAL ORDER.
COMPOSITÆ.

A GARDEN PRODUCTION.

If the value of a genus increase as the production of handsome and superior varieties result from impregnation between the species already known to belong to it, the present has certainly made within the last few years considerable augmentation in this respect. Many very showy and even splendid hybrids are now known in our gardens as the result of the transference of the pollen from one species to another, and others equally meritorious are now and then springing into notice in different parts of the country, as rewards of the industry and active skill of the gardener. There is every encouragement to look for still further improvement in this genus; and with equal satisfaction and pleasure may we look forward to others already known as the parents of many varieties, the profuse number and striking beauty of whose flowers contribute in more than an ordinary degree to heighten the beauty of our flower-gardens; indeed, to what extent may we not carry our anticipations when we look around and glance at what has been done in our flower-gardens within the lapse of only a few seasons? The exertions which have recently been made by scientific gardeners, and the numerous discoveries abroad, have filled our borders with many ornamental flowers in which they had formerly been deficient; whilst plants of endless variety, with regard to height, habit of growth, and colour, are now crowding upon us, to the gratification of every true lover of nature.

The handsome variety here represented will in some measure prove the justice of our remarks, and show, in a faint degree, how much the growing novelty and advancing gaiety of our greenhouses, flower gardens, &c., are owing to the laudable exercise of the cultivator's wisdom and practical skill, when studiously turned to the assistance and furtherance of nature's capabilities in the production of superior and additional beauties.

We learn from Mr. James Tate, gardener to John Waterhouse, Esq., of Well Head, Halifax, after whom it is named, that it is the result of seed produced between *C. tussilagofolia* and *C. cruenta*, resembling in its general appearance and mode of growth the former more than the latter, but is of more humble growth, the flowers more numerous and splendid.

It flowers in March, and continues until the end of June or beginning of July, when young off-sets spring from the roots, by which it is easily increased. The mode of cultivation is very simple and easy:—see below.

In December, January, and February, there are no plants that add more liveliness and interest, combined with a good share of beauty, to our greenhouses than some species and varieties of the genus *Cineraria*; and it is not only at this dull season that these plants become objects of such gaiety, but they may be brought into a perfect state of flowering in the months of May and June, when they become available as well for the flower-garden as the greenhouse. Indeed, when well managed, the beauty and attractiveness of the former are much increased by a bed or two being filled with good plants of the most showy and dwarf-growing varieties. One species especially merits cultivation, viz., *C. cruenta*. This may be regarded as the parent of many of those beautiful varieties which are so successfully cultivated by Messrs. Henderson, in whose nursery they make a splendid show in the spring months. The following is the method of treatment which we have followed with success for a length of time. The seed of *C. cruenta* in general ripens about April and May, when it should be immediately sown, for we always find it the best way to raise young plants from seed every season; and as this species is liable to sport a good deal from seed, we take care to mark, when they are in bloom, those which produce the largest corymbs, and when the seed is ripe it is carefully collected and sown, by which the flowers of the succeeding season come much superior. The seed should be sown as soon as ripe in good-sized pots of light rich mould, and placed in a gentle heating hotbed, where they will soon vegetate; when they have made two or three leaves, they should be transplanted into small sixties, using the same light rich compost as before recommended, and replaced in the frame; in a short time they will require a larger sized pot, which should be immediately given, and so on until they reach the size of 32, in which they may be allowed to flower. Towards the middle or latter end of October, if they have had proper attention, such as water, air, pot-room, &c., they will commence throwing up strong flower-stalks from the centre, when they should be placed in a light part of the greenhouse, where they will begin flowering in December, and continue beautiful for several months. To have them in a flowering state in May and June, the following simple method should be followed. Sow the seeds, as before directed, about May, and when the young



THIS PAGE IS LOCKED TO FREE MEMBERS
Purchase full membership to immediately unlock this page



Never be without a book!

Forgotten Books Full Membership gives universal access to 797,885 books from our apps and website, across all your devices: tablet, phone, e-reader, laptop and desktop computer

A library in your pocket for \$8.99/month

Continue

*Fair usage policy applies



Daviesia latifolia.



THIS PAGE IS LOCKED TO FREE MEMBERS

Purchase full membership to immediately unlock this page

DELVE INTO FANTASY, MAGIC, MYTHOLOGY & FOLKLORE

Forgotten Books'
Full Membership gives
access to 797,885 ancient
and modern, fiction and
non-fiction books.

Continue

*Fair usage policy applies

DAVISIA LATIFOLIA.

(BROAD-LEAVED DAVISIA.)

CLASS.
DECANDRIA.ORDER.
MONOGYNIA.NATURAL ORDER.
LEGUMINOSÆ.

GENERIC CHARACTER.—See vol. iv., p. 29.

SPECIFIC CHARACTER.—A neat greenhouse shrub, about three feet high. *Branches* erect, long, few in number, angles scarcely evident. *Leaves* alternate, entire, oval, in length twice the width, each with a small mucro at the apex. *Flowers* in axillary, usually solitary, racemes, occasionally in pairs. *Bracteas* persistent, longer than the pedicles, concave, reflexed, reddish. *Calyx* bell-shaped, with short, almost equal, teeth, upper lip truncate. *Vexillum* emarginate. *Alæ* (wings) linear, nearly the length of the vexillum. *Carina* single-petaled, short. *Filaments* distinct. *Germe*n oblong, compressed, two-seeded. *Style* at right angle with the germe

ALTHOUGH an excellent hardy greenhouse plant, it seldom appears in a high state of health with the best cultivation, owing to there generally being a scarcity of branches, and consequently a want of foliage. It is a most profuse flowerer, as many as six densely-set racemes being often seen on one branch springing from the axils of the leaves; the flowers have a pretty appearance, being lined with dark pink, while the border is a bright yellow, and the vexillum copper-coloured and spotted. The flowering season is from May till August.

This species should form a part of every collection; it is cultivated like the rest of the genus, without any great difficulty, thriving well in equal parts of loam, peat, and sand, in the greenhouse.

We take this opportunity to remark, in respect to the treatment required for New Holland plants, that the proportions of soil should be well incorporated previous to using, without sifting, in which case there is not half the danger of any part setting, as the loam is rather liable to do if not well blended with the peat and sand, which is to some extent injurious; the peat should be rather fibrous. A good quantity of reduced pots should be used for drainage, and the plants, while growing, watered every day, or oftener if necessary; but as this depends so much on the situation in which the plants are standing, we can only say that they should never be allowed to get dry while growing, but when the growing season is over

they must not be suffered to get wet; or, in other words, no oftener will they require water than is just sufficient to keep the roots from shrivelling. When potted, a moderate shift is best, and the new soil, without disturbing the old ball any further than removing the loose pots at the bottom, should be carefully packed round the roots with a neat stick prepared for the purpose: see Article on Potting, in another part of this Number.

The species is a native of Van Dieman's Land, where it was detected by Robert Brown, Esq., and introduced to our gardens in 1805. Multiplied readily from cuttings in sand.

We have again to thank our liberal friend and willing contributor, Mr. Bowe, of Manchester, for the drawing of this plant; it may be obtained of nearly any London or country nurseryman at little cost.

The generic name, *Davisia*, will be found explained at page 30, vol. iv.



THIS PAGE IS LOCKED TO FREE MEMBERS
Purchase full membership to immediately unlock this page



Never be without a book!

Forgotten Books Full Membership gives universal access to 797,885 books from our apps and website, across all your devices: tablet, phone, e-reader, laptop and desktop computer

A library in your pocket for \$8.99/month

Continue

*Fair usage policy applies

When persons attempt to repot a plant, they but too often press and work about the old ball, to clear off and loosen the soil, then, after putting into a larger pot some common garden mould, they place the disturbed roots upon it, fill the surrounding space with the same mould, shake or strike the pot, water the surface, and bring the plant into a sitting-room, or perhaps place it in the open air on some bed of earth. This is a supposed case, it is true, but if it do not exactly apply, certain it is that the nurseryman employs soils, which his experience teaches him will suit the constitution of his plants, and bring them to a showy saleable condition. The purchaser is unable to obtain a compost, or even a pure loam, or vegetable earth of a similar character, and thus an ungenial medium is applied unskilfully about the roots; while the foliage of the plant is exposed to every inequality of light, air, heat, and water, which belongs to a sitting-room. If garden mould be used, or if the pot be placed in a border, *worms* are liable to be introduced, or to find ingress to the roots, and then woe to the plant; for, to say nothing of the direct injury they may occasion, those sappers gradually undermine the roots, perforate the soil, and make it a complete gallery by their contortive evolutions. Thus they produce all the evil consequences which result from loose and incompact potting, and also defeat the attempts to furnish a proper supply of water; for the holes they bore are just so many channels through which the fluid passes, without moistening the body of the soil.

The remarks on the treatment of *cuttings* are just and correct; we only wish to add a word on two material points. Whenever sand (clean writing, or silver sand, or pure siliceous earth, free from adhesive matters) is employed, it will not be amiss to saturate it with water before it be put on the soil in the pot; it will then act as a *quicksand*, embracing and closing upon the cutting, and entirely excluding the air from the heel; so prepared, it is readily kept moist and free, whereas sand, if applied dry, receives water with great difficulty. In taking off and preparing a cutting, we have frequently found it better to cut, not *through the joint*, but a trifle below it; this will leave the part completely perfect. At every joint a bud or system of life exists, and this it is which in ordinary cases propels the first radical processes; by not injuring the vital point we act prudently, and on the same principles as when in "budding" a tree or shrub we carefully retain the *eye* of the bud, for without *that* there can be no success. The importance of buds or eyes is always kept in view by a practised gardener; but it must not be overlooked that in every case where the peculiar state of the wood, as to age or ripeness, which the individual plant required, is equally at command, a *slip* will succeed better than an ordinary cutting, because it abounds with *embryos* of buds at its base, and these are most active in the production of those minute fibrous processes, which in the first instance establish the connexion between the cellular alburnum of the infant plant and its earthy medium of nutrition. We are indebted for the hint to nurseryman of eminence, when conversing upon the means of propagating *Gardenia*; the rule is not without exception, but it is of the first consequence, and should be always retained in the mind.

REMARKS ON *FICUS STIPULATA*.

THIS very interesting evergreen creeper, to succeed well and show itself in proper character, should be planted in a good-sized pot or in a border, and allowed to run of its own accord without training over any part of the back wall or rafters of the stove; but that part where the greatest degree of moisture prevails suits it best, where with proper treatment it grows very rapidly, and has an extremely novel and interesting appearance, the dark glossy leaves and wild profuse character of the branches give it quite an air of elegance. If the wall to which it is permitted to grow be kept constantly damp, it thrives amazingly, and attaches itself to the mortar, stones, or wood, as firmly as ivy to the bark of a tree, by means of little wire-like roots, which are sent out in great numbers in all directions from the branches; these roots feed upon the atmosphere to such an extent, that after the plant is established on the wall, it derives very little support from those in the soil; sometimes the upper parts of the branches are seen with leaves so much larger than those on the lower parts, that any one unacquainted with the fact would scarcely believe them to be produced by the same plant. The soil best for it is good open loam and peat: rooted plants may be taken off at any time without injury. It is not much infested with insects, although the common enemies of the stove delight to feed upon its juices, but if frequently washed with the syringe these enemies will not do any harm. Although the species is said to produce fruit much like the common fig (see figure) just before it begins to ripen, we have not heard from any quarter of a plant upon which fruit has been seen in this country, and we believe under the common method of cultivation it will not readily fruit. And certainly a large plant spreading itself over the back wall of a stove, bearing even a small quantity of fruit, would have a very novel and beautiful appearance. If a large strong-growing plant was to be deprived of water in the winter in a low temperature, to such a degree as not to endanger its life, it would very likely, the following season when re-excited, show a quantity of fruit, which with careful management would, no doubt, come to maturity. It would at least not be amiss to make the trial.

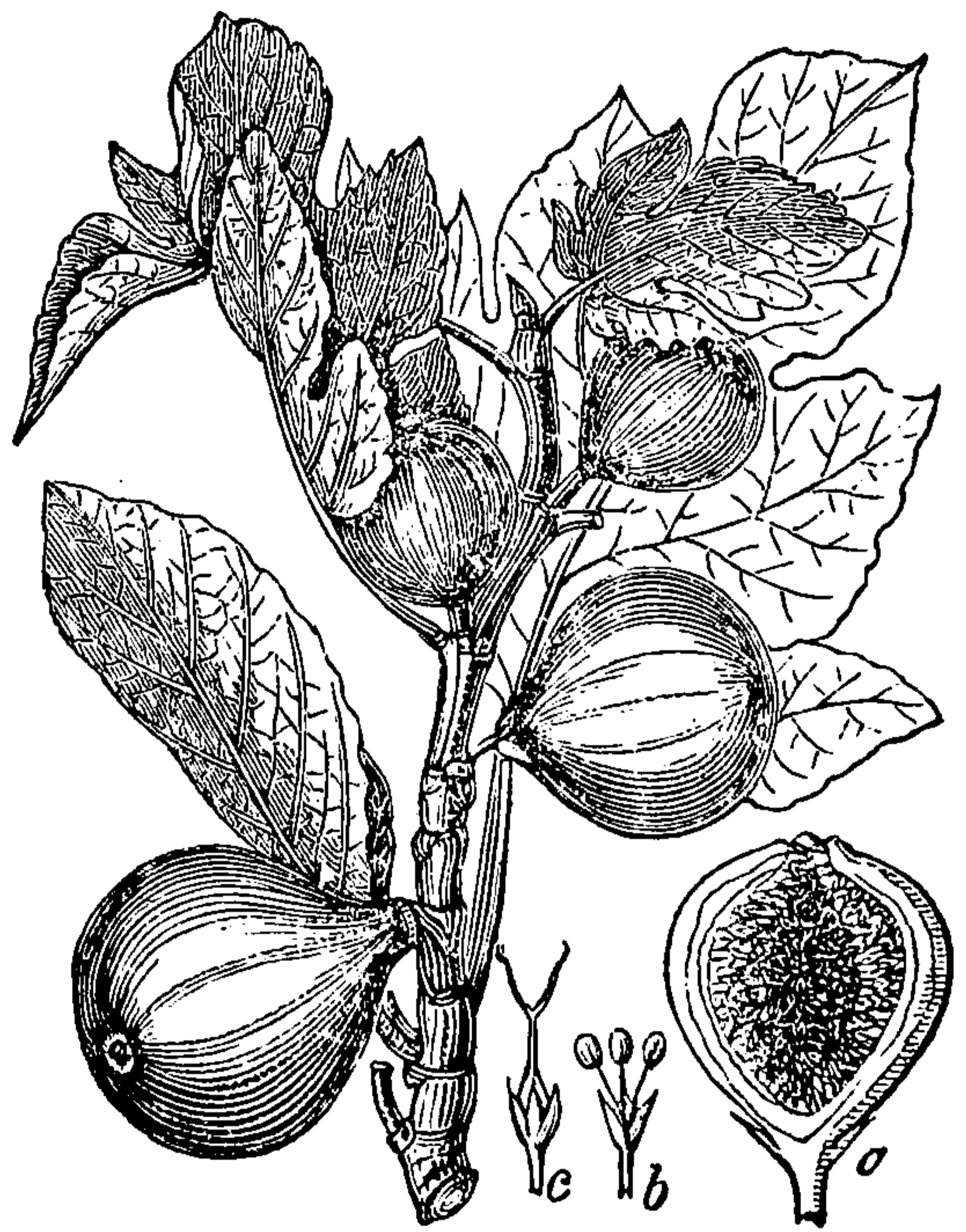

ON SOILS.

DEFINITE APPROPRIATE TERMS INDISPENSABLE.

WE have been favoured with a letter from a highly respectable correspondent noticing our article on Soils, vol. ii. p. 187 to 192, and approving of our proposed alteration of terms, particularly as applied to that very valuable species of earth which within the last few years has been improperly designated PEAT. If the reader take the trouble to review the article in question, he will perceive that the earth to which the names of *bog-earth*, peat, sandy and turfy-peat, *have been* and *are* applied, is that in which our native heaths are found to grow and flourish. We will re-copy a few lines from p. 191: "All these terms are *applicable only* to *heath mould*; and they express the varying texture of that material. The sandy heath-soil of Bagshot is of a greyish black tint, it contains a very great proportion of pure white sand, with perhaps scarcely one tenth part" (of the hundred) "of black, decayed, vegetable matter. The best heath-soil contains much fibrous matter, and is of a black or brownish hue, which depends upon the peculiar nature of the vegetable matter. All these soils abound with pure white sand; hence, their peculiar applicability to plants whose roots are very fibrous, tender, and delicate."

By the terms peat and bog-earth, writers have always intended to express heath-soil, in contradistinction to the real bog-peat dug from turbaries. Gardeners rarely think of the latter; if they do, they know it to be inert, in consequence of its being the production of a swamp. But we must not wholly reject this soil, for we have seen proof sufficient that the mass, after being *exposed for years to the air*, will bring some plants to the highest state of rich verdure. We have seen and grown Thunbergia in a pot of *pure bog-peat* (20 years old before it was used), the leaves of which became of an intense green, and almost double the breadth of those cultivated in loamy soils.

We also admit that the heath-soils differ one from the other; that some specimens are quite loose and sandy, with little appearance of fibre; while others are firm in texture, come up in lumps of a buttery adhesive consistence, which may almost sanction the mistake of confounding heath or moor-soil with bog-peat.

This unctuous, adhesive mould, is however the product *of the surface*: it abounds with heath-roots and grass, and, chemically examined, it is found remote from the bog-soil dug far *below* the surface. It may however require additions of pure siliceous sand.

We are very glad to be again called upon to re-urge this subject, and trust our horticultural friends, one and all, will reform this abuse of terms—not in part but altogether. Let us define our terms, write and speak correctly, and not adopt one appellation when we mean to express another.

We were the first, we believe, to write urgently on this subject, and to make it an affair of consequence: it is but just however to observe, that mention was made, in a short article of the Gardener's Magazine, of the confusion of terms; and directions given thereby to distinguish the inert substance of the bog from the true and valuable sandy soil of the moor or heath.



THIS PAGE IS LOCKED TO FREE MEMBERS

Purchase full membership to immediately unlock this page

DELVE INTO FANTASY, MAGIC, MYTHOLOGY & FOLKLORE

Forgotten Books'
Full Membership gives
access to 797,885 ancient
and modern, fiction and
non-fiction books.

Continue

*Fair usage policy applies

HINTS ON THE CULTURE OF TELFAIRIA PEDATA.

THIS beautiful and extraordinary perennial plant is found in abundance at the margins of the forests near the shores of Zanzibar, where it envelops the trees with its branches, while its trunk is frequently seen with a circumference of eighteen inches; when properly managed it is excellently adapted for training over the back wall of a stove or other part that it may be desirable to hide in a short space of time, for it will grow in one season enormously, and cover an extent of surface almost incredible; and when trained and dressed neatly it looks very ornamental. It should either be planted in a large tub, or border, or, if convenient, a part of a pit might be partitioned off and filled with soil, either of which will suit it, but where the roots are not confined it will flourish best, as it is, like the rest of the family, a very gross feeder. It thrives exceedingly well with us in a mixture of sandy loam, peat, and dung, the largest portion of the former; but whether this is most proper for causing it to produce fruit is questionable, for it appears to us that stiff soil, such as is commonly in use for melons, will be more likely to hasten the production of fruit. It requires stove heat, and to be supplied with abundance of water, and the whole plant to be regularly and forcibly washed with water, or the *acarus* (red spider), thrips, &c., will materially injure the leaves, and render it in a great measure unsightly.

The flowers are somewhat showy, being of a purplish colour, and very much fringed at the margin of each petal, but the fruit is the most valuable and striking feature; it has been thus described in the *Bot. Mag.* p. 2752.

“The fruit constitutes an enormous berry, or pepo, from one and a half to three feet in length, and often eight inches across, oblong, always green, having from ten to twelve deep furrows, the prominences rounded, the bottoms of the furrows rough, with minute elevated points, as is the concave part where the stalk is inserted; the apex is acute, or shortly acuminate, and near the base is a contraction, so that the very base forms a dilated, furrowed apophysis. There are five cells, each cell filled with a dense fleshy pulp, in which the seeds are imbedded horizontally, in a longitudinal series. Each seed is the size of a very large kidney-bean, between orbicular and cordate, much compressed, even a little concave on one side, and firmly enclosed in a beautiful yellowish brown, but tough, and almost coriaceous, reticulated mass of vessels, quite distinct from the seed itself, whose integument is hard and thick, yellow-brown, on both sides marked near the margin with an elevated line, and in the disc, or centre, it is prettily embossed with many serpentine lines. Although the outside of this be brownish, the inside (or that next the almond) is a deep and almost bright yellow, and the intermediate part is a fine black. The whole internal cavity is occupied by the embryo, except a thin membranaceous, brownish covering, adhering to it, which perhaps may be considered as albumen. Cotyledons two, of the same shape as the seed, pure white, fleshy, and rather oily. Radicle inferior, small, conical.”

Mr. Telfair, of the Mauritius, through whose means it has been introduced to this country, adds, "The fruit is three feet long, and eight or ten inches in diameter, full of seeds as large as chestnuts (two hundred and sixty-four in one fruit), which are as excellent as almonds, and have a very agreeable flavour, and when pressed they yield an abundance of oil, equal to that of the finest olives. I have distributed seeds over the Mauritius to the island of Bourbon, and have sent some to New Holland, and even to Otaheite, and New Zealand, to the missionaries." Thus will Mr. Telfair have the honour of giving a most useful vegetable to mankind at large, as well as a name to a new and most beautiful plant. It belongs to the 22nd class *Diœcia* and 13th order *Monadelphia* of the Linnæan system, and *Cucurbitaceæ*, the gourd tribe of the natural system. The whole of the plants in this order have succulent stems, climbing by means of tendrils formed by abortive leaves, and are well described in the accompanying figure of *Cucumis Colocynthus*, or bitter cucumber. This species is a native of Africa, and produces its flowers from May till August. The male flowers have the calyx fine toothed, the corolla five parted, the stamens three. The female flowers have the calyx and corolla like the male, and the pistil is three cleft.

"Its fruit is about the size of an orange; its medullary part, freed from the rind and seeds, is alone made use of in medicine; this is very light, white, spongy, composed of membranous plates, of an extremely bitter, nauseous, acrimonious taste. The fruit is gathered in autumn, when it begins to turn yellow, and is then peeled and dried quickly, either in a stove or in the sun. Newmann got from 7680 parts, 1680 alcoholic extract, and then 2160 watery; and, inversely, 3600 watery, and 224 alcoholic. The seeds are perfectly bland, and highly nutritious; and we learn from Captain Lyon, that they constitute an important article of food in Northern Africa. The extract of colocynth is one of the most powerful and useful of cathartics, but there is no more efficacious way of reducing its violence than by reducing its dose."

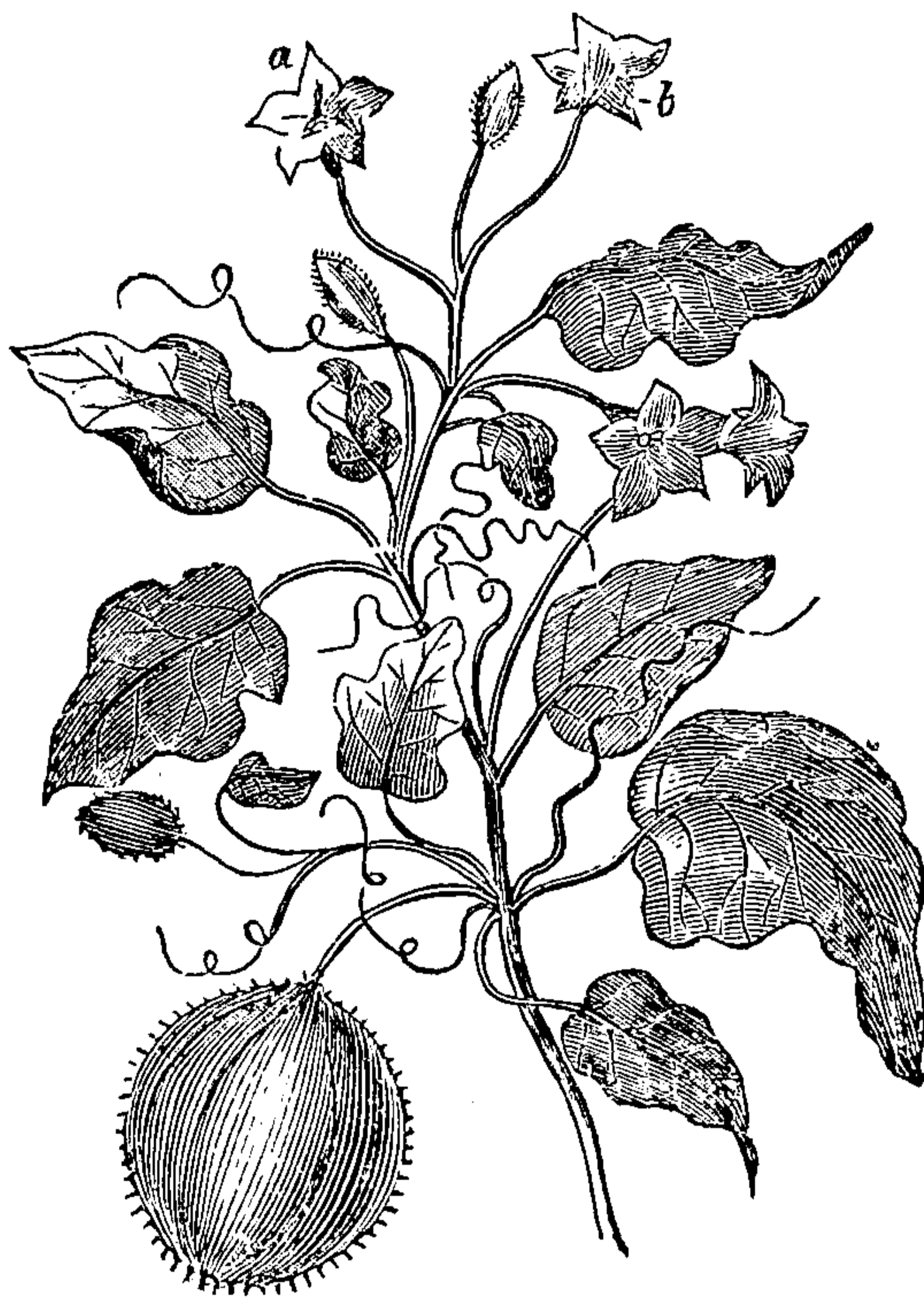

SLEEP OF LEAVES.

THE phenomenon to which we allude is called the sleep of plants. This consists in a periodic change in the position of an entire leaf, or of the several leaflets of which a compound leaf is formed. The petioles, or leafstalks, either bend upwards or downwards, so that the flattened surface or limb of the leaf is elevated or depressed. There are about a dozen modifications in the manner in which the leaves are inclined to the stalks on which they grow; some raise their leaflets so that their upper surfaces are brought into contact; and others depress them so that the under surfaces meet together. This phenomenon is best exhibited by various species of the two natural orders; the *Leguminosæ* (which includes both the pea-flowering plants, as clover, &c., and the Acacias and Mimosas, &c., which have regular flowers), and the *Oralideæ*. These phenomena depend upon a special physiological law, subject in some degree to the stimulating effects of light and heat which elicit and control them, but which are not themselves the primary causes of these effects. When the sensitive plants are confined in a dark room, their leaflets periodically fold and open as usual, except that the periods are somewhat lengthened; on the other hand, when they are exposed to a continued light, these periods are shortened. When exposed to strong lamplight by night, and excluded from all light by day, their periods of sleep become extremely irregular for a time; but, in the end, the specimens generally close their leaves during the day, and unfold them at night.

The alternate opening and closing of flowers is a similar function to that of the sleep of leaves. The time of day in which flowers close is very different for different species, and even differs for that period during which the leaves are asleep on the very same plant. Bertholet mentions an Acacia in the garden at Arotava in Teneriffe, whose leaflets closed at sunset and unfolded at sunrise, whilst its flowers closed at sunrise and expanded at sunset.—*Henslow's Botany, in Dr. Lardner's Encyclopædia.*

NEW AND RARE PLANTS,

FIGURED IN THE LEADING BOTANICAL PERIODICALS FOR OCTOBER.

CLASS I.—PLANTS WITH TWO COTYLEDONS (DICOTYLEDONEÆ).

THE CAMPANULA TRIBE (CAMPANULACEÆ).

CAMPANULA PORTENSCHLAGIANA. Dalmatian Wall Campanula. A pretty little herbaceous species, hardy in the milder parts of Great Britain, it however succeeds best if kept in a greenhouse in winter. It is a native of the walls and rocks in Dalmatia, whence it was introduced by the Hon. W. F. Strangways. *Bot. Reg.* 1995.



THIS PAGE IS LOCKED TO FREE MEMBERS
Purchase full membership to immediately unlock this page



Never be without a book!

Forgotten Books Full Membership gives universal access to 797,885 books from our apps and website, across all your devices: tablet, phone, e-reader, laptop and desktop computer

A library in your pocket for \$8.99/month

Continue

*Fair usage policy applies

flowers it is exactly intermediate between that species and *erubescens*. The flowers are dull purple, and are produced in June. *Brit. Fl. Gard.* 401.

ASCLEPIADEÆ.

PHILIBERTIA GRACILIS. Slender Philibertia. This is a new and striking species, copiously clothed with soft spreading hairs; the stem is slender and twining, about six feet long, the leaves are opposite, stalked, green on both sides, an inch and a half long; the flowers are of a yellowish white, thickly studded with purple lines and spots, and are produced from the peduncle, which is from an inch to an inch and a half long. It was discovered by Mr. Tweedie, in the country between Buenos Ayres and Tucuman, who forwarded seeds of it to his correspondents. The plant was raised in the garden of Dr. Neill, Edinburgh, in the spring of 1836,—it flowers in June. *Brit. Fl. Gard.* 403.

CLASS II.—PLANTS WITH ONE COTYLEDON (MONOCOTYLEDONÆ).

THE LILY TRIBE (LILIACEÆ).

ANTHERICUM GLAUCUM. Glaucous-leaved Anthericum. An interesting South American fibrous-rooted plant. The top of the root is covered with rigid fibres, the weathered remains of old leaves, from which the recent ones spring, these are one and two feet long; the scape is from one to three feet high, bearing a long raceme of rather large pure white flowers, mostly three together from each bractæ, but of these one only opens at a time and that only for a day. The species inhabit the vicinity of Lima, and the tubers were received at the Glasgow Botanic Garden from J. Maclean, Esq., of that city. Flowers from August to September. *Bot. Mag.* 3610.

THE ORCHIS TRIBE (ORCHIDEÆ).

ERIA STELLATA. Star-flowered Eria. The stem of this handsome species is creeping, and bearing what may be considered *pseudo-bulbs*, clothed with larger scales, and each of these having two broadly lanceolate leaves marked with five longitudinal ribs. The scape rises from the base of the leaves, long, curved, clothed with ferruginous down, and bearing copious pale yellowish green flowers nearly the whole length. "It is considered to be a native of Java, but when and by whom introduced is not known. It was first described in this country from plants which flowered in Mrs. Cattley's collection. The long, curved spike of copious, fragrant, stellated flowers, and the creeping habit, with ample and graceful foliage, combine to render this a most desirable plant for our stoves." *Bot. Mag.* 3605.

MILTONIA SPECTABILIS. Showy Miltonia. This is a truly beautiful Brazilian Orchideous plant, named in compliment to Earl Fitzwilliam, for the zeal which that nobleman has displayed in the cultivation of that beautiful tribe of plants. The genus is nearly related to *Brassia*, *Cyrtochilum*, and *Oncidium*: differing from the latter in its lip being slightly connected with the column, much dilated and

undivided; and from *Brasia* and *Cyrtóchilum*; in its column being auricled, and its lip not only much larger than the sepals, but also altogether different in form. The flower is produced from a short, erect, compressed stem rising from the base of the *pseudo-bulb*; the sepals are pale greenish white, the lip a beautiful violet. It flowered with Messrs. Loddiges, in July last. *Bot. Reg.* 1992.

. *APORUM ANCEPS*. Two-edged *Aporum*. A very remarkable plant, agreeing with *Dendrobium* as concerns the fructification, but differing in the distichous equitant leaves. It produces several stems from the same roots, six to eight inches long, jointed and leafy the whole length, leaves lanceolate, and sheathing at the base. The flowers are solitary, rising from the sheaths, having two bractees at the base, almost lemon-yellow. Its native country is the estuaries of the rivers of Bengal and Pegu, where it is found on the trunks of trees in swampy situations, and whence it was introduced by Dr. Wallich to the garden of the Horticultural Society. It flowers in May. *Bot. Mag.* 3608.

NOTICES OF NEW AND RARE PLANTS

IN FLOWER IN THE LEADING NURSERIES IN THE VICINITY OF LONDON.

MESSRS. HENDERSON'S, Pine-Apple Place. *Eutoca viscida*. This extremely beautiful annual is still in flower at the above nursery; and, from the brilliant colour and great profusion of its pretty blue blossoms, as well as the great length of time it remains in flower, no collection should be destitute of so desirable a summer ornament to the flower-garden. *Lychnis Bungeana*. A very fine specimen of this splendid plant is now in flower in the greenhouse of the above nursery; and as the centre of the flowers is of a much lighter colour than usual, we were led at first to believe that this plant was a variety of the before-named species, but this is probably owing to the season of the year, or some local circumstance connected with it. Many beautiful species of *Erica* are now finely in flower at this nursery, and we may here add that, perhaps, no person in the vicinity of London propagates and cultivates this extensive and much-admired genus more successfully than the Messrs. Henderson; and nothing contributes more to enhance their beauty than the degree of taste and neatness with which they are here potted and tied up.

MR. KNIGHT'S, Chelsea. *Cattleya labiata*. This magnificent plant, which appears to supersede, in point of real beauty, all other known species of *Orchideæ*, and seems to defy every attempt made to represent it faithfully on paper, such is the exquisite beauty and richness of its flowers, is now flowering in perfection at the above nursery; and we are convinced it only needs to be seen at once to be admired, and its merits justly appreciated; on this account we should think no lover of *Orchideæ* would willingly long deprive his collection of such a highly-beautiful and desirable ornament. Mr. Knight has recently flowered a new species of *Cattleya*, bearing some resemblance to *C. labiata*, but in many points essentially different from it; the flowers are quite as large as those of the species just men-

tioned, and the petals and sepals are similar in colour to it, but the lip is considerably longer, does not expand so much, and is not undulated at the edges; besides this, it is not of a purple colour, but of a somewhat lighter colour than the petals, with a rich purple mark round the edges; the leaves are also longer and not so broad; it may probably be considered a variety of *C. labiata*, but even a variety of so splendid a species cannot fail to form a desirable and valuable accession to any collection, particularly when it is equally beautiful.

MESSRS. LODDIGES', Hackney. *Trichocentrum fuscum*. This is a highly interesting and new Orchideous plant, and is now flowering most profusely in the rich collection of the above gentlemen. The petals and sepals of the flowers are of a dull-brown colour, the labellum is white, with a few stripes of pink, and there is a tail to the flower of about an inch in length, which gives it rather a singular appearance; as it flowers frequently, and produces its pretty blossoms in great abundance, it will be a decided acquisition to any collection. *Sophranitis cernua*. This is not a new, but is, we believe, a rare Orchideous plant; however this may be, it is an extremely elegant and interesting one. The foliage is small, nearly round, and thick, and reclines on the block of wood to which it is attached; the flowers are of a bright red colour, with a little yellow in the centre; they are produced (generally six or seven in number) on a short scape, and have a peculiarly modest and attractive appearance. *Oncidium Lanceanum*. There are two or three specimens of this splendid species now in flower at this nursery, one of which is a decided variety.

MR. LOW'S, Clapton. *Convolvulus Pintestun*. This is a new and very pretty species of *Convolvulus*; the flowers are small, and are produced in dense clusters at the axil of every leaf; they are of a bright blue colour, and the smallness of them is sufficiently counterbalanced by the immense number produced; it is a stove-climbing species, and is well worthy of a place in every collection. *Euphorbia punicea*. A remarkably fine specimen of this truly splendid (though old) plant is now beautifully in flower in the stove of the above nursery. Several new and good species of *Grevillea*, *Hakea*, &c., appear likely to result from importations of seeds made by Mr. Low from New Holland, &c., and he appears to possess an excellent stock of that elegant and truly desirable plant, *Euphorbia fulgens*.

MESSRS. ROLLISONS', Tooting. *Aporum indivisum*. This is, we believe, a new species of this genus; and though there is nothing striking in its appearance, the flowers being very small, it is nevertheless pretty; the flowers are produced in terminal clusters, and in general appearance it is somewhat similar to *A. anceps*. *Calanthe densiflora*. A good specimen of this beautiful species is now in flower at the nursery before named; and, with its densely-covered spikes of pretty yellow flowers, it has a very interesting and attractive appearance. *Brassia lanceana*. This fine Orchideous plant is now flowering in great perfection in the choice collection of the above nursery, and merits a place in every collection. Messrs. Rollison have recently made some additions to their stock in the genus *Dendrobium*, and others which are new.

MR. YOUNG'S, Epsom. *Tropæolum tuberosum*. This plant, which has been



THIS PAGE IS LOCKED TO FREE MEMBERS

Purchase full membership to immediately unlock this page

DELVE INTO FANTASY, MAGIC, MYTHOLOGY & FOLKLORE

Forgotten Books'
Full Membership gives
access to 797,885 ancient
and modern, fiction and
non-fiction books.

Continue

*Fair usage policy applies

The situation in which they are placed is an area of about thirty or forty feet square, which is formed by being nearly surrounded by the greenhouses and conservatory from which the plants are taken. In the centre of this area is a walk paved with stone, which runs to another part of the nursery, and there is another walk across the centre in an opposite direction. The whole of the surface of the ground (excepting these walks) is covered with a good layer of coal ashes; these not only prevent the worms from rising and getting into the pots, and the bottoms of the pots from being clogged up with soil so as to prevent proper drainage, but make an excellent surface to walk upon. We have however seen a system practised for keeping down worms, and ensuring a dry, firm, and even surface, to place plants of this description on, which it may be well here to detail. On the piece of ground selected for the purpose, a quantity of stiff clay is placed of about three inches in thickness, which is beaten or trodden down as firmly as possible; on this is placed another layer of clay to the thickness of about two inches more, which is likewise beaten down very firm; after being left a few days to settle, a slight layer of common mortar is placed over the whole, taking care to keep the surface level; this, when dry, will make a surface almost as hard and level as stone, although, where this latter article can be procured readily and cheap, it is much more effectual and durable; but the method just detailed is particularly beneficial where the situation is low and consequently wet. But to return to our former position; a dry surface being ensured by coal ashes, so as to prevent the intrusion of worms, and form good walks, from the central walks before named other ones are made to diverge, in such a manner that each bed or cluster of plants is entirely surrounded by a walk, so as to afford facilities for watering. Between the central walk and the houses, the plants are arranged in beds of various size and shape according to taste, the smallest plants being placed nearest the walk, and the others arranged so as to rise higher and higher, till, finally, the largest plants occupy the space nearest the houses, thus forming a regular and gradual slope. To describe or enumerate the various species of which these beds are composed would be impossible; suffice it, for a general outline, to say that the beds nearest the centre are composed in some instances of small Alpine plants, many of which being in flower have a very pretty appearance, and two large slate orange tubs are placed in an inverted position, one on each side of the central walk (at regular distances from each other and the houses), on the tops of which are placed Alpine and other small plants in flower, which give the whole a more diversified and less formal appearance, and are intended as substitutes for vases; which, it is needless to observe, would look far better. The remaining beds near the centre are filled up with young plants of the various species of *Erica*, *Epacris*, &c., and the others with plants of a larger size, always placing the tallest plants in the centre of the bed; by putting a few plants of *Petunias*, *Lobelias*, or any other plants that may be in flower, in each bed, the whole is made to present a very lively and interesting appearance. As the beds approach the houses, large plants, such as *Rhododendrons*, *Acacias*, and other plants that attain a large size, are used, and, divided as it is into almost numberless small beds, and intersected with walks, the whole has the appearance of a curious and

novel kind of flower garden. We are aware that this system cannot be practised to so great an extent in small collections; but even in these, the plants would look much prettier and more ornamental if arranged in small beds of various shape and size, than in straight, oval, or other kinds of large and unsightly masses, and in this system nothing is seen of the pots except those small ones which stand nearest the central walk. In conclusion, we may add, that beds of various shape and size cut out in a lawn, in some retired part of the pleasure ground, the soil from which has been taken out, and the beds filled with coal ashes for placing greenhouse plants upon during the summer months, would have a very neat and pretty appearance, and deserves extensive notice.

OPERATIONS FOR NOVEMBER.

It is of the first consequence in managing plants that require protecting from cold violent winds, dashing rain, and frost, that they have particular and steady attention during winter, for when these plants have been exposed to the action of the open air, with all the variations of temperature, &c. during the summer months, and come to be taken on the approach of winter into a glass-house, or frame, the change from an out-door to an in-door climate would very perceptibly injure them, were it not that the degree of heat is modified and brought as near as circumstances will admit to that of the external air. It then follows as a consequence, that the greatest pains in preserving plants through the winter season are required; more particularly the first few weeks after bringing them from the open air, or until such time as they become inured to the in-door climate. Many times, plants after having completed their growth in the open air are brought and staged in the greenhouse, where they commence a new growth as though it was spring—to their great injury when the proper growing season arrives; this is entirely attributable to improper management. Among frame and half-hardy plants, similar effects have been witnessed. As the houses, &c. are now being filled with their winter stores, we cannot too earnestly entreat attention to the following hints:—Give air in abundance both back and front of the house, when the weather is mild and not too windy. Warm the flues a little for the purpose of drying up damp, but let this be done in the day when the ventilators are open, and the artificial heat thus produced, in conjunction with the air, will speedily expel the damp; if done in the night, as is too frequently the case when the house is close, the effect will be bad. Water not with a rose, but individually with a small-spouted pot that does not carry a deal of water or make any unnecessary wet, as the nights at this time of the year are very long and cold; it is necessary and indeed preferable to water all kinds of plants in the morning, so that all superfluous moisture may have a chance to pass off before evening; it is also well to avoid watering the foliage as much as possible. Plants of all descriptions in frames and pits must never be left exposed in rainy

weather at this season; still every opportunity should be taken to give a plentiful supply of air, when the weather is fine and mild: water as directed above.

STOVE.

THE most important operations in this department at this season, consist in keeping the plants clean and neat, and properly watered. The temperature in the night should not exceed 70° , and in the day not 75° . Succulents will mould and rot if not watered with the utmost caution. Bulbs of *Amaryllises*, &c. will not need any water until they show symptoms of growth, when they should receive a little, and be removed into a somewhat higher temperature for early spring flowering. *Ferns* should be daily watched, and watered sparingly; the tender kinds and seedlings, as well as those not well established in the soil, often suffer from want of attention in this respect.

GREENHOUSE.

KEEP succulents free from damp. Give plenty of water to flowering chrysanthemums. Decayed branches and decaying leaves should be carefully removed. *Camellias* that were started very early last spring, and have been since kept in heat, will be now in flower; they may be brought into the greenhouse, where they make a pretty show; those having the blossoms not open, yet swelling for expansion, should have plenty of water, as without it they are very liable to throw the flowering buds. Any desired to flower early in the spring should be taken into the Pine Stove or other place where a little heat is kept. Bulbs if well tended will flower strong and abundantly. Seeds of *Stocks*, *Larkspurs*, *Schizanthus*, *Salpiglossis*, &c., sown last month should now be potted off and placed in a light situation. *Nemophila insignis*, *atomaria*, *aurita*, &c., sown early in this month, carefully watered, &c. during winter, will make fine plants for flowering in pots in the spring. A little seed of *Clintonia pulchella* might be sown and carefully managed till spring.

FLOWER-GARDEN.

SEE directions for last month, page 216. Pot off young seedlings; attend immediately, if not already done, to the potting off of young Pink Pippings if sufficiently struck. Tender species of *Pinus*, border plants, or indeed tender plants of any description that the frost is liable to injure, should be judiciously protected with mats, awning, or other efficient material. Dahlia roots should be looked after; a little coarse material over the roots will secure the surface buds from nipping frosts. Temporary awning, where practicable, will preserve the flowers for a short time against slight frosts and cutting winds.

Attend to winter operations, such as digging and manuring the borders, dividing roots of perennials, &c. where too large, repairing edgings, effecting improvements, &c. &c.



THIS PAGE IS LOCKED TO FREE MEMBERS
Purchase full membership to immediately unlock this page



Never be without a book!

Forgotten Books Full Membership gives universal access to 797,885 books from our apps and website, across all your devices: tablet, phone, e-reader, laptop and desktop computer

A library in your pocket for \$8.99/month

Continue

*Fair usage policy applies



Brugmansia Waymaniana





THIS PAGE IS LOCKED TO FREE MEMBERS

Purchase full membership to immediately unlock this page

DELVE INTO FANTASY, MAGIC, MYTHOLOGY & FOLKLORE

Forgotten Books'
Full Membership gives
access to 797,885 ancient
and modern, fiction and
non-fiction books.

Continue

*Fair usage policy applies

In the nearly allied genus *Datura*, we find the species *fastuosa* described as occasionally bearing semi-double flowers, but an instance so strange and unusual as that we now record never before came under our notice. The flowers are somewhat fragrant, and appear about May and June.

Sandy peat, and loam mixed with a little well-decomposed manure, will make a suitable compost for it. It is a free grower, therefore should have plenty of water, both at the roots and over the branches; and what is of greater importance, plenty of pot room.

Propagated freely from cuttings in sand in a little heat under a glass. Messrs. Webber and Pierce, of whom plants may be obtained, have hitherto treated it in the greenhouse, but think it will flower in the open air in summer.

We have named it in compliment to Sir H. Digby's intelligent gardener, Mr. Wayman.



Pentstemon Cobaea.



THIS PAGE IS LOCKED TO FREE MEMBERS
Purchase full membership to immediately unlock this page



Never be without a book!

Forgotten Books Full Membership gives universal access to 797,885 books from our apps and website, across all your devices: tablet, phone, e-reader, laptop and desktop computer

A library in your pocket for \$8.99/month

Continue

*Fair usage policy applies

PENTSTEMON COBÆA.

(COBÆA-FLOWERED PENTSTEMON.)

CLASS.
DIDYNAMIA.ORDER.
ANGIOSPERMIA.NATURAL ORDER.
SCROPHULARIACEÆ.

GENERIC CHARACTER.—*Calyx* in five parts. *Corolla* two-lipped, ventricose (blown up). *Fifth filament* longer than the rest, and bearded at the upper end. *Capsule* two-celled, two-valved, somewhat compressed. *Seeds* naked.

SPECIFIC CHARACTER.—A hardy perennial. *Stem* slightly downy all over, upwards of two feet high, erect, nearly round or obtusely angular. *Leaves* opposite, the upper oblong, half amplexicaul, the middle ones oblong, narrower at the base and sessile, the radical or root leaves oval spatulate, petioled, somewhat glossy, and dentate at the margin. *Flowers* produced on a terminal panicle. *Peduncles* bearing from three to five large almost white flowers, tinged with purple. *Calyx* divided into five pointed segments. *Corolla* with an enlarged considerably inflated tube. *Limb* consisting of five spreading segments, inside white mixed with a little yellow, and marked with red. *Filaments* fertile, curved. *Anthers* reniform. *Fifth filament* lengthened, somewhat clavate, furnished internally at the apex with long hairs. *Capsule* ovate, two-valved. *Seeds* numerous, chaffy.

THIS handsome species of *Pentstemon* lately flowered with our valued friend and neighbour Mr. Cooper, of Wentworth, who with his usual kindness communicated the sample for the drawing in August last.

The species was discovered by Mr. Drummond in the interior of Texas, and by him seeds were forwarded to the Glasgow Botanic Garden in 1835, but we are informed that Mr. Nuttall originally found it on the prairies of the Red River, growing in calcareous soil.

In the *Bot. Mag.*, page 3465, Sir W. J. Hooker observes, in respect to this species—"Handsome as is this species of *Pentstemon*, the native specimens gave me reason to expect a more splendid plant than that which is here represented." And again—"Certain it is, that the flowers on some of our dried specimens are nearly twice as large as those here represented." Bearing these remarks in mind, and comparing our figure with that in the *Bot. Mag.*, a question arises whether this may not prove to be the more splendid one Sir W. J. Hooker was led to expect, from the native specimens he examined; for certainly the flowers here represented

are larger, and in every other respect much finer, than that in the *Bot. Mag.*; but considering that the properties of the flowers have been known to vary as the treatment has been good or bad, or the season of flowering favourable or unfavourable, we feel inclined to consider the greater size and beauty of the flower here shown as most probably attributable to these causes. As an instance, in the *British Flower Garden*, page 348, we find the flowers there represented to differ from those in the *Bot. Mag.* both in size and shade of colouring, which is accounted for by the plants flowering at different seasons. Whether the view here taken be correct or not, our present experience does not enable us to say; but if so much depends on culture, how necessary it is that the best method should be properly made known, and carefully practised!

For want of the necessary information, we are obliged to defer our remarks on culture, &c. to the succeeding number, when we shall take pains to point out that system of management which experience has proved to be advantageous to the growth of this splendid plant. Plants or seeds may be obtained of any of the London and most of the country nurserymen.

The generic name is explained in Vol. III., page 266.

The specific name is given by Mr. Nuttall, on account of the magnitude, and sort of general resemblance of the flowers to those of *Cobæa scandens*.



THIS PAGE IS LOCKED TO FREE MEMBERS

Purchase full membership to immediately unlock this page

DELVE INTO FANTASY, MAGIC, MYTHOLOGY & FOLKLORE

Forgotten Books'
Full Membership gives
access to 797,885 ancient
and modern, fiction and
non-fiction books.

Continue

*Fair usage policy applies



Costus speciosus.

DEC^r 1837.



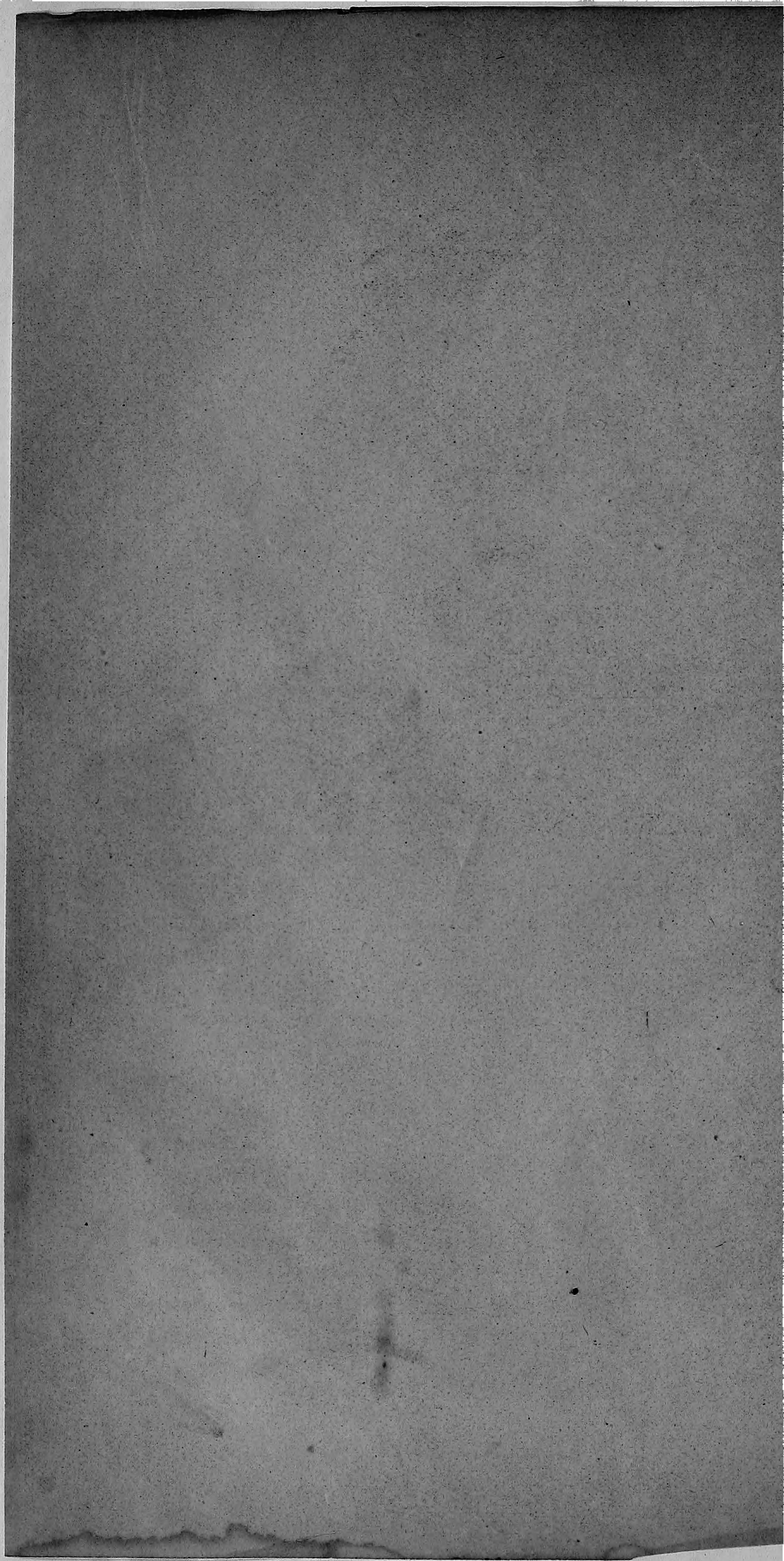



THIS PAGE IS LOCKED TO FREE MEMBERS
Purchase full membership to immediately unlock this page



Never be without a book!

Forgotten Books Full Membership gives universal access to 797,885 books from our apps and website, across all your devices: tablet, phone, e-reader, laptop and desktop computer

A library in your pocket for \$8.99/month

Continue

*Fair usage policy applies

die; a short time after this they must be cut off, the pots placed in a dry cool situation, and the roots scarcely watered again until spring.

Young plants are obtained by dividing the roots.

This species is a native of the East Indies, and flowers from August till September.

Our drawing was taken from a plant in flower in Messrs. Rollisons' nursery, at Tooting, in August last.

The generic name is substituted for the Arabic appellation, "*Gorth.*"



Cattleya Harrisonia.



THIS PAGE IS LOCKED TO FREE MEMBERS

Purchase full membership to immediately unlock this page

DELVE INTO FANTASY, MAGIC, MYTHOLOGY & FOLKLORE

Forgotten Books'
Full Membership gives
access to 797,885 ancient
and modern, fiction and
non-fiction books.

Continue

*Fair usage policy applies

CATTLEYA HARRISONIÆ.

(MRS. HARRISON'S CATTLEYA.)

CLASS.
GYNANDRIA.NATURAL ORDER.
ORCHIDEÆ.ORDER.
MONANDRIA.

GENERIC CHARACTER.—See vol. i. p. 151.

SPECIFIC CHARACTER.—An Epiphyte. *Stems* very numerous, each from twelve to sixteen inches long, rather slender, and slightly furrowed between four apparent angles, two of which, one on each side, are most obvious. *Leaves* nearly dark green, flat, upwards of six inches long, of an ovate figure tapering nearly to a point. *Spathe* three inches long, generally rounded at the top. *Flowerstalk* nearly round, supporting mostly four or five flowers. *Sepals* nearly equal in size, of a delicate but beautiful rose and blue colour. *Lip* two inches and a half in length, paler than the sepals, somewhat curved downwards. *Column* half the length of the lip and overlapped by it, of a pale colour.

AMONG cultivators of *Orchideæ*, this superb plant has long been known as Mrs. Harrison's variety, having been considered merely a variety of the well-known species *C. Loddigesii*; but after repeated observations on these two plants when both in a high state of flowering, we feel satisfied that we have not done wrong in considering it in the light of a distinct species, and therefore have named it in compliment to the late Mrs. Harrison (the name it has gone under as a variety), of Aigburgh, near Liverpool. The points wherein these two plants differ, have been for such a length of time so perfectly constant, that the greatest reliance may with safety be placed upon them. They are chiefly to the following effect:—The stems of *C. Loddigesii* are more rounded, invariably stronger, and shorter than those of *C. Harrisoniæ*, which always appear more delicate, are less bulky, and five or six inches longer; in the leaves also there is a striking difference, those of the former being firmer, broader, and always of a darker texture; but perhaps the most obvious disagreement will be found in the flowers, for while those of the former have the sepals and petals considerably reflexed downwards, and freckled as it were over every part except the lip, with small dark purple spots, those parts of the latter are scarcely at all bent, and entirely free from spots. In a word, so strikingly different is the aspect of these two plants, even when not in flower, that any one seeing them

side by side, would not for a moment question the propriety of considering them distinct species, upon the grounds set forth above.

When the plant from which our drawing was taken was in full flower in the Orchideæ house at Chatsworth, in the autumn of the present year, we must say that there are few known vegetable displays that could surpass it in beauty, the colour being almost inimitable; it is second only to the noble plants of *C. labiata*, in the collection of Earl Fitzwilliam at Wentworth, when in their greatest gaiety, with from twelve to sixteen large dazzling blossoms. The plant this season has made no less than twelve good shoots, nine of these have flowered mostly with five good blossoms, which remained more or less perfect for upwards of two months.

Numerous as are the species of beautiful Orchideæ now in our collections, wonderful is the fact that we as yet know, comparatively speaking, little of what vast numbers there remain to be introduced, for there is scarcely an importation but can boast of its twenty, thirty, and sometimes many more new and undescribed species.

Districts where this family is known to abound in rich profusion, have been, some not at all, and others only partially visited as yet. Who can form an idea of the extent of those vegetable beauties which our great Creator has yet in reserve to be ultimately made known! Indeed, who, not so long since, would have thought of the already many beautiful and interesting forms which now adorn our stoves!

“ But God,
Inspiring God! who boundless spirit all,
And unremitting Energy, pervades,
Adjusts, sustains, and agitates the whole.
He ceaseless works alone, and yet alone
Seems not to work; with such perfection framed
Is this complex, stupendous form of things.
But though concealed, to every purer eye
The informing Author in His works appears.”

For culture, &c., see vol. i. page 151, and page 122 of this volume, where also the generic name is explained.

We know nothing of the history of this plant, any further than that it has been several years in many orchideous collections, and originated in the first place, it may be presumed, in that of the late Mrs. Harrison.



THIS PAGE IS LOCKED TO FREE MEMBERS
Purchase full membership to immediately unlock this page



Never be without a book!

Forgotten Books Full Membership gives universal access to 797,885 books from our apps and website, across all your devices: tablet, phone, e-reader, laptop and desktop computer

A library in your pocket for \$8.99/month

Continue

*Fair usage policy applies

at Spofforth, persuades me that when their cultivation is found difficult, a soil that is more disposed to set firm, and not fall to pieces when turned out of the pot, should be substituted, with good drainage and cautious watering. The difficulty is to find a light soil which has a little tenacity. There is a yellow earth of that nature in which I have observed *Erica cinerea* thrive with much greater vigour than in any black soil, in the neighbourhood of the New Forest, which would perhaps suit the *Cyrtanthi*. In a soil of that nature all Mr. Woodford's *Ericæ* were cultivated at Rickmansworth. The earth of Mitcham Common was so congenial to the *Ixias*, that in it I have had seventy-two flowers from one bulb of *Ixia longiflora*, and nearly as many from one of *Spiraxis grandiflora*, whereas the confluent soils of this neighbourhood, though favourable to the hardier *Gladioli*, destroy the *Ixias* and *Babianas*, and are not favourable to *Sparaxis*."

ON HIPPEASTRUM.

"THERE is some difference as to the cultivation of the various species of *Hippeastrum*, in consequence of the several latitudes, altitudes, and situations, in which they are found. Capricious watering is their bane; they should be watered pretty freely while they are making leaves, more sparingly after they are grown, and not at all when at rest. *Aulicum* I have found very difficult to manage; I have had but two or three roots of it, and have not been satisfied with their treatment. *Calyptratum* flourished well with me in light soil on the hothouse flue, growing all the year round, till I was told by a gentleman that they had been found to succeed better in the greenhouse, and having transferred them according to his advice, I lost all my bulbs of that species. *Psittacinum* and the beautiful mules between it and *Regio-vittatum* are hardy greenhouse plants, requiring absolute rest in the winter, and flower freely in the spring; they grow weak in the stove, and will not flower without rest. *Solandriflorum* and *Stylosum* are tender stove plants, but should rest in winter time. *Vittatum* is a greenhouse plant, requiring rest in winter, and may be brought into the stove in spring to flower it. In Surrey it lived well, flowered yearly, and sometimes ripened seed, in the open ground near the south front of my house, a small heap of ashes being thrown over it in winter. The mules between *Psittacinum* and *vittatum* would perhaps bear as much exposure if the wet could be kept from them in winter. *Reticulatum* and *striatifolium* are tender stove plants, and I believe the former is nearly lost, and its habitation has never been exactly ascertained. Of latter years the striped-leaved variety has been frequently sent from Brazil, but the original plant has not been met with. The mules between *striatifolium* and different varieties of *bulbulosum*, as well as *regium* and *regio-vittatum*, have a hardier constitution, and many of them come so near to the reticulated parents, that they will be preferred in cultivation for ornaments. *Equestre* is a plant of singular constitution, and frequently lost in the stoves; though a native of the hottest regions of the west, it will not live if watered constantly in the stove. It requires absolute rest in winter, in a moderately cool but not damp situation; it will flower early in the summer, and after flowering should be placed in the greenhouse, or in the open air, where it will grow better than in the stove.

Regium requires less care, the stove, and rest in winter. The whole family of *bulbulosum*, except *crocatum*, are easily managed. By giving them two periods of rest, in winter and again at midsummer, they, as well as the mules, *regio-vittatum* and *rutilo-regio-vittatum*, may often be made to flower in the spring and autumn. I have found great advantage with bulbs that were to stand on a hot flue, in placing under them a shallow tray, made of tin or zinc, and nearly filled with sand. In pursuance of this system of encouraging their growth, by moist warm sand underneath, a gentleman to whom I had given several tender bulbs informed me that he had constructed a pit for them with a chamber, into which was introduced a slender steam pipe, perforated with small holes; and the chamber was covered with hurdles, over which he placed a layer of brushwood, and on that a body of sand, in which the pots were plunged. The steam worked its way through into the sand, and kept up a moist warmth, which was very congenial to the tender bulbs during their season of growth; and I do not conceive that any better mode of cultivation could be adopted. A bed of the various splendid *Hippeastra*, successfully cultivated in a low warm house, would exceed most vegetable displays in beauty. Some of the varieties of *H. bulbulosum*, if not all, may be found in South America, growing in black vegetable earth. My collector found *pulverulentum* in such soil with the scape three feet high, and the leaves long; and I discovered *equestriforme* growing unperceived in a mass of parasitic plants, *Cereus* and *Pitcairnia*, which had been torn off a stem or the face of a rock. I have, however, lost so many bulbs by the use of peat at various times, that I am generally fearful of using it. There is so much variety in the vegetable black earth of different places, that it should be tried cautiously. I have been told that *H. calyptratum* has been found growing on the branches of trees, and that it has been necessary to shoot off the limb by repeated discharges of a gun, in order to get the bulb; and I have seen it grown in a pot of moss. The principal causes of the sickly state of *Hippeastra* in cultivation, are too light a soil, want of water when the leaves are pushing, and too much water after. I have observed them grow with unusual vigour in a split or broken pot, in consequence of better drainage. The finest bulbs I ever saw were two self-sown seedlings from a cross-bred plant, which established themselves in the pot where *Convolvulus Gangeticus* was growing. They killed the *Convolvulus*, and at last broke the pot, and have not been so vigorous since; in consequence of its falling to pieces, it became necessary to shift them. It is evident that good drainage is essential to their health. With earth that sets firm, that object may be effected better by a single crock placed carefully so as to cover only part of the hole, than by many, of which the lowest covers the aperture, and the remainder become choked by the earth settling amongst them. I have had seedlings of crosses with *vittatum*, which sent up two stems of blossoms from a pot scarcely twice the size of the bulb. A self-sown seedling established itself in one of my stoves, and is growing freely on a stump of wood, into the cavity of which a little peat had been thrown to encourage the growth of a *Pleurothallis*; and I do not doubt the bulbs being often found on old trees, amongst the ferns, and other parasites; but I consider a well-drained rich alluvial soil to be most fit for bringing them to perfection. They appear to have

gone rather out of favour lately with cultivators, probably from failures through mismanagement, for certainly they can be surpassed by few flowers in beauty, and most of them may be cultivated in a warm greenhouse, if they are kept quite dry in the winter ; but it should be always remembered that very tender bulbs, which are to be kept dry in a greenhouse, will rot if above ground from the dampness of the atmosphere, though they would have been uninjured if closely covered by light earth."

"It is now pretty well understood that, although cuttings of *Camellia Japonica* strike root readily in sand, a light and confluent soil is fatal to the growth of the plant, causing the young leaf to turn yellow, become spotted, and fall off, especially if exposed to the sun ; a well-drained stronger soil being essential to their health. Most sorts of *Hippeastrum* seem to me liable to suffer from the same cause, which is apparently too rapid evaporation of the moisture which they require. The more frequent watering, which becomes necessary to the development of their leaves, occasions the decay of the fibres. Due attention to this point will make the cultivation of the bulbs of this genus easy to those who have been unsuccessful in their treatment, always bearing in mind that, the stronger the soil used, the more perfect should be the drainage. Strong loam and a cool situation, with complete rest in winter, suits *H. vittatum*, and I believe that *Aulicum* will succeed best with the same treatment. I consider that *Hippeastrum* generally does not thrive well in soil which is powdery when dry, and does not set."

This work we warmly solicit those of our readers who desire to improve or extend their knowledge of bulbous plants to purchase, being perfectly convinced that another so well calculated for that purpose cannot be found. Looking over the genus *Crinum*, we observe a variety named *Careyanum*, on which the author has the following lines, which we extract for the purpose of laying before our readers some account of that eminent man, in memory of whom the above variety of *Crinum* is named, and to whom the succeeding remarks relate. "This beautiful plant was brought to light by Dr. Carey, late of Serampore, and I had the pleasure of naming it after one of the best, the most amiable, gifted, and indefatigable of men ; whose virtues and talents adorned his country, and whose labours have promoted the glory of the Almighty. I never saw this excellent man, but fifteen years' correspondence had accustomed me to look upon him as a deeply valued friend. His life was devoted to the diffusion of the gospel ; horticultural, natural history, and botany, afforded the brief recreation he allowed himself from his daily toils. His favourite plants were the Amaryllidaceous family, and to him we are indebted for our knowledge of many of them. He was born in 1761, at Hackleton, in Leicestershire, and embarked for India in 1793. In 1800 he was settled at Serampore, and he closed the labours of his useful life in 1834, beloved by all who knew him, honoured by all whom his name has reached, having translated and superintended the publication of the gospel in forty oriental languages, which he had the perseverance to acquire for that purpose. Born in the humblest circumstances, often uncertain of his daily bread, at first a journeyman shoemaker, then a village schoolmaster, he had before his departure from England taught himself to read the Bible in Greek, Latin, Hebrew, French, Italian, and Dutch, and had become



THIS PAGE IS LOCKED TO FREE MEMBERS

Purchase full membership to immediately unlock this page

DELVE INTO FANTASY, MAGIC, MYTHOLOGY & FOLKLORE

Forgotten Books'
Full Membership gives
access to 797,885 ancient
and modern, fiction and
non-fiction books.

Continue

*Fair usage policy applies

round the branches; the flowers are of a beautiful brilliant red, slightly variegated and produced in the greatest profusion in loose panicles on the young shoots—these panicles are axillary; when the blossoms are at the greatest height of perfection, the whole plant appears one complete mass of flowers; added to its truly lovely blossoms, and the brilliant display they create in the wilds of India, is its stunted peculiar habit. It is well ascertained that the generality of shrubs prefer a situation where there is a body of soil or a quantity of decayed vegetable matter for their roots to run amongst, but this plant is remarkable for fixing itself upon the trunks of trees and upon huge rocks, where there is seldom any trace of the least particle of soil of any description. And in point of situation, it is by no means particular, for it is frequently found growing upon large prominent rocks and trunks of sturdy old trees, fully exposed to the influence of a tropical sun, and at other times in the midst of almost impenetrably dense woods, at an elevation of four thousand feet; at its root it produces immense thick fleshy nodosities, some of which are as thick as a man's body, and equalling four or five feet in length; these nodosities coil themselves round the trunks of those trees on which they fix, and round large portions of rocks they adhere and twist in a surprising manner, penetrating every fissure and chasm within their reach, in order to fortify themselves from being torn up by the merciless hurricane: besides the purpose of climbers or tendrils, they serve as reservoirs of nutriment for the future use of the plant, particularly through the dry or hot season, during which they become contracted, wither, and decrease in circumference, and appear as though they did not contain the least particle of moisture; but no sooner does the rainy season return, than they refill themselves, become bulky, assume their original size and fatness, and as the plant increases, so these nodosities enlarge and extend in the same proportionate degree.

CULTURE.—Either of the fine species named above will grow freely if merely laid on the surface of a body of soil in a moist shady part of the greenhouse or a cool part of the stove, providing they are furnished with similar reservoirs for moisture as above described; but as it is perhaps more desirable to have fine specimens of these plants in pots or tubs for the convenience of moving about, it will be the best way to plant the roots in soil.

In the process of potting or tubbing, care should be taken to keep the thick portion of the root on the surface, else they will probably rot; the small fibrous roots should be only just covered.

Any rich light soil will answer, but that which is close and retentive is highly objectionable.

PROPAGATION.—If branches are taken carefully off in spring, and put into good-sized pots, and placed in a moist shady part of the stove under a glass, they will immediately make young roots: while in the striking pot, they require only a moderate supply of water; but when older, and growing, they delight in a liberal quantity.

During the cold season, that is about December, on the Khoseea Hills the above species may be seen in a state of perfection rarely equalled or surpassed in the whole range of vegetable life.

ON MANURES AND COMPOSTS.

THE pure or simple earths alone do not perform any material part in the process of vegetable nutrition; they may be considered as the media by which the plant is supported, and through which it is enabled to supply itself with the aliment necessary to the growth and development of its parts.

That aliment appears to be furnished either by decayed vegetation naturally (*i. e.* by absorption of the products of natural fermentation, either from the surface of the ground, or floating in the atmosphere), or artificially, and chiefly by the organic materials applied by labour. The earths so supplied with organic matter are called soils, and are said to be manured; and it now remains to examine the nature and composition of various composts, which experience has proved to possess properties fitted to recruit the soil with matter of which it has been deprived by the crops that it has borne.

“Vegetable and animal substances deposited in the soil, as is shown by universal experience, are consumed during the process of vegetation; and they can only nourish the plant by affording solid matter capable of being dissolved by water, or gaseous substances capable of being absorbed by the fluids in the leaves of vegetables. Mucilaginous, gelatinous, saccharine, oily, and extractive fluids, carbonic acid, and water, are substances that, in their unchanged states, contain almost all the principles necessary for the life of plants; but there are few cases in which they can be applied as manures in their pure forms; and vegetable manures in general contain a great excess of fibrous and insoluble matter, which must undergo chemical changes before they can become the food of plants.” “If any fresh vegetable matter which contains sugar, mucilage, starch, or other vegetable compounds, soluble in water, be moistened, and exposed to the air, at a temperature of from 55° to 80°, oxygen will soon be absorbed, and carbonic acid formed; heat will be produced, and elastic fluids, principally carbonic acid, gaseous oxyde of carbon, and hydro-carbonic gas, will be evolved; a dark-coloured liquid, of a sour or bitter taste, will likewise be formed; and if the process be suffered to continue for a time sufficiently long, nothing solid will remain, except earthy and saline matter, coloured black by charcoal.”

“Animal matters in general are more liable to decompose than vegetable substances: oxygen is absorbed, and carbonic acid and ammonia formed in the process of their putrefaction. They produce fetid, compound, elastic fluids, and likewise azote. They afford dark-coloured acid and oily fluids, and leave a residuum of salts and earths mixed with carbonaceous matter. The principal animal substances which constitute their different parts, or which are found in their blood, their secretions, or their excrements, are, gelatine, fibrine, mucus, fatty or oily matter, albumen, urea, uric acid, and other acids, saline and earthy matters.”

“Whenever manures consist principally of matter soluble in water, their fermentation and putrefaction should be prevented as much as possible. To prevent

manures from decomposing, they should be preserved dry, and kept as cool as possible."

Vegetable substances convertible into manures embrace a vast variety of articles too numerous to be detailed; among these are green succulent plants and weeds of every description, and sea weed. These ought to be dugged into the ground as soon after their death as possible, as if exposed to the air they readily ferment, and consume almost to nothing. Green crops, pond weeds, and parings of hedges and ditches, or any kind of fresh vegetables, require no preparation to fit them for manure; but dry straw, spoiled hay, and other vegetable matter, should be broken up by previous fermentation, as should moist woody fibre, peat, and tanners' bark. Tanners' bark particularly demands notice, as it has been deemed useless, if not injurious, to land, and consequently has become a burdensome stock to the tanner, owing to its rapid accumulation. On this subject I quote the following authorities from Loudon.—A. Young attributes the deleterious effects of bark to the "astringent matters which it contains." Lord Meadowbank has judiciously recommended a mixture of common farm-yard dung, in the proportion of one part to three or four of peat; "and tanners' bark will probably require as much dung to bring it to fermentation as the worst kind of peat. It is evident, from the analysis of woody fibre, by Gay-Lussac, and Thenard (which shows that it consists principally of the elements of water, and of carbon, the carbon being in a larger proportion than in other vegetable compounds), that any process which tends to abstract carbonaceous matter from it, must bring it nearer in composition to the soluble principles; and this is done in fermentation, by the absorption of oxygen and production of carbonic acid." A similar effect is produced also by quick-lime.

Manures of animal origin are supposed to require but little or no chemical preparation: they may be introduced at once into the soil. The great object is to blend them with the earths equally and perfectly, so as to prevent too rapid a decomposition. Among the animal substances are, muscular flesh, fish, bones reduced to fine powder, hair, woollen rags, feathers, blood, urine, dung of cattle, &c., night-soil, and soot. But the great mass of manures is procured from the stable, or farm-yard, where the excrements of horses, cattle, swine, and poultry, are blended indiscriminately with straw and every kind of litter. Soot is principally formed from the combustion of coal, and contains substances derived from animal matters. "It is a very powerful manure; it affords ammoniacal salts by distillation, and yields a brown extract to hot water, of a bitter taste; it likewise contains an empyreumatic oil. Its great basis is charcoal, in a state in which it is capable of being rendered soluble by action of oxygen and water. This manure is well fitted to be used in a dry state, thrown into the ground with the seed, and requires no preparation." Soot is also inimical to vermin, and sometimes is used in preventing the ravages of the insects which attack young turnips, carrots, &c.—(*Gard. Manual.*)



THIS PAGE IS LOCKED TO FREE MEMBERS
Purchase full membership to immediately unlock this page



Never be without a book!

Forgotten Books Full Membership gives universal access to 797,885 books from our apps and website, across all your devices: tablet, phone, e-reader, laptop and desktop computer

A library in your pocket for \$8.99/month

Continue

*Fair usage policy applies

country-seats, at the time they were so much in vogue. These country-seats were generally castellated, and defended by moats or walls. The terraces within these boundaries were usually confined spaces, where there was just room to form a geometric flower-plat. The time arrived, however, when these defences were no longer necessary, and on their demolition the field of action of the gardener, together with his cramped taste, were expanded at once; he stretched his dressed ground over the surrounding lawn, and associated it with the neighbouring woods.

From this time the Italian topiary-work disappeared; and an entirely new style was adopted, especially in this country. Wresting the forms and objects of nature into the patch-work of the sempstress, the scroll-work of the house decorator, or the precise resemblance of kaleidoscopic reflections, were condemned as bad taste; and a more exact imitation of nature, as to *irregular disposition*, became "the rage."

In this revolution, perhaps, we have gone too far; because as all gardens are artificial associations, it may as well be avowed at once, as endeavour to deceive ourselves and others by concealing our art merely by irregular dispositions. Geometric gardens are therefore, now-a-days, not regarded, as they were some years ago, with abhorrence; but are considered as rather a desirable feature when introduced with judgment.

Falling in with this change of taste, and thinking, as already observed, that they may be made very interesting, when filled with a proper selection of flowering plants, we present the following isometrical view of the middle of a flower plat, which has the novelty of a trellis over the walks where they cross each other. Isometrical drawing has the double advantage of combining both plan and elevation in one view; and is particularly useful in illustrating garden scenery. In no other *single view* would the station and elevation of this trellis have been represented, as a glance at the plate will evince. The use of the trellis need hardly be adverted to; it is intended for beautiful climbers, which should always have a conspicuous place in the flower-garden. The erection may be formed of either wood or iron; the standards let into sockets of wood or stone, permanently fixed in the ground, though the standards and hoops may be moveable.

No extension boundaries are traced in the plate; but it may occupy either a circular or rectangular spot, with a surrounding walk; and the angles outside the cross walks, may be turf, dotted with roseries or single plants.

Our artist has introduced here a very elegant *Dolphin Fountain*, which would be a highly ornamental object in such a pattern. On the propriety of introducing sculptured figures, or models of antique sculpture, into flower-gardens, we shall have something to say on another occasion; especially as we have been supplied with a collection of beautiful drawings of Grecian, Etruscan, Oriental, and Grecian vases, &c., which we intend to present in a future number.

The lower sketch on the plate, is another isometrical view of a parallelogrammatic flower-garden laid out in circular plats, surrounded by walks with box edgings. The beds are planted with an irregular collection of flowers, or are grouped according to the taste or fancy of the manager.

NEW AND BEAUTIFUL PLANTS,
FIGURED IN THE THREE LEADING PERIODICALS FOR NOVEMBER.

CLASS I.—PLANTS WITH TWO COTYLEDONS (DICOTYLEDONEÆ.)

PEDALIACEÆ.

MARTYNIA DIANDRA. Diandrous Martynia. This is a pretty tender annual, which Dr. Lindley says is quite worth cultivation, notwithstanding a somewhat unpleasant smell emitted by the leaves when pressed. The flowers, which grow in short racemes from the axil of the leaves, are of a most delicate pink, fading to white, with the tips of the lobes of the corolla deeply stained with crimson; moreover, a bright yellow-broken streak passes down the tube of the corolla from the middle of the lip. It is found inhabiting the neighbourhood of Vera Cruz, whence it was long ago introduced to this country, although now seldom seen. It requires the treatment of a cockscomb, or any similar tender annual. *Bot. Reg.* 2001.

BIGNONIACEÆ, OR THE TRUMPET-FLOWERED TRIBE.

TECOMA JASMINOIDES. Jasmine-leaved Tecoma. This charming greenhouse climbing shrub is an evergreen, not uncommon in collections, but so seldom flowering that Dr. Lindley, only in August last, heard for the first time of its blossoms having been formed in Messrs. Chandlers' nursery. It is said to be a native of New Holland, and to have been originally received at the royal gardens at Kew. The flowers seem to be produced on terminal racemes in considerable numbers, the segments are white, while the eye is red or purple, which look very pretty. *T. australis* is the species to which this seems to approach the most closely, but the latter is far more beautiful, and must be considered one of the finest of its handsome race. *Bot. Reg.* 2002.

PHILADELPHACEÆ, OR THE SYRINGA TRIBE.

PHILADELPHUS SPECIOSUS. Showy Syringa. This is a hardy shrub, growing to the height of eight or ten feet, by no means formal, but with gently bending branches loaded with snow-white flowers of the largest size, and scentless. It is among the least common of the genus, although much the handsomest. Dr. Lindley intends figuring the other species by degrees, which we are glad of; and he says, as the task of doing so is proceeded with, the distinctions between them will be more apparent than any thing that could be said without the figures. *Bot. Reg.* 2003.

GESNERIÆ. THE GESNERIA TRIBE.

GESNERIA DOUGLASII; var. VERTICILLATA. Mr. Douglas's Gesneria; whorled var. This is a charming variety, tubers of which were imported from Rio by Mr. Allcard. The flowers are arranged in immense numbers in dense whorls, and look extremely handsome. *Bot. Mag.* 3612.

POLYGALEÆ. THE POLYGALA TRIBE.

POLYGALA MYRTIFOLIA: var. GRANDIFLORA. Myrtle-leaved Milkwort, large-flowered var. This plant has gone under the name of *T. grandiflora*, and as such was figured by Messes. Loddiges in the *Bot. Cab.*; but Dr. Hooker thinks it only a slight variety of *P. myrtifolia*. It is a much-branched shrub, from four to six feet high, with oblong, somewhat pointed, smooth green leaves, and produces its lively purplish blossoms in April and May, which continue a long time in perfection. *Bot. Mag.* 3616.

ASCLEPIADEÆ. THE ASCLEPIAS TRIBE.

PHILIBERTIA GRANDIFLORA. Large-flowered Philibertia. An extremely handsome *Asclepiadeous* plant, of which seeds were sent to the Glasgow Botanic Garden by Mr. Tweedie, from Buenos Ayres, but the native country is Tucuman. It will probably succeed in the greenhouse, for which place its twining habit well suits it. The flowers are cream-coloured, prettily dotted and streaked with purple within. *Bot. Mag.* 3618.

ASCLEPIADEÆ.

TWEEDIA CÆRULEA. Blue-flowered Tweedia. This beautiful and interesting plant was discovered by Mr. Tweedie in Buenos Ayres, by whom seeds were sent to this country. The flowers are blue, and produced in clusters of four to five together upon a footstalk an inch and a half in length, arising from the axil of the opposite cordate-lanceolate entire green leaves. Its natural habit is twining, but young plants, says Mr. Don, raised from cuttings are frequently erect, and blossom when they scarcely have attained a foot in height. It is a plant that we hope soon to see in all our flower-garden collections. *Brit. Fl. Gard.* 407.

ROSACEÆ. THE ROSE TRIBE.

ROSA INDICA: var. BLAIRI. Blair's New China Rose. This splendid rose is a hybrid production, having been raised by Mr. Blair seven years ago from seeds of the yellow China, which had been fecundated by the pollen of the Tuscan rose. Its aspect is more robust than that of the other varieties of the China rose, and is remarkable for the size of its leaves and flowers. The petals are yellow at the base, especially towards the centre of the flower, and are besides frequently furnished with a white stripe along their middle, a character also present in the common blush China rose. The blossoms are produced in abundance, they are very showy and fragrant, and their colour is of a rich purple. It is a strong-growing kind, and there are few varieties more worthy of cultivation. It may be increased by cuttings, or successfully budded upon the *Rosa canina*, or any other of our larger native roses. *Brit. Fl. Gard.* 405.

SCROPHULARINEÆ.

MIMULUS LUTEUS; var. WILSONI. Miss Wilson's Monkey-flower. This singularly beautiful variety was raised at Miss Stamford's, Stanhard House, Stamford Hill, from seeds of the *M. luteus*. Like the other varieties of the same species, it



THIS PAGE IS LOCKED TO FREE MEMBERS

Purchase full membership to immediately unlock this page

DELVE INTO FANTASY, MAGIC, MYTHOLOGY & FOLKLORE

Forgotten Books'
Full Membership gives
access to 797,885 ancient
and modern, fiction and
non-fiction books.

Continue

*Fair usage policy applies

but it has not been stimulated by any artificial heat, and if this character proves permanent, it will doubtless be valuable. In the Orchideæ house we were surprised to find the *Cattleya labiata* still in flower; its splendid blossoms have now been expanded full two months, and this feature in its habits holds out still stronger inducements to the lovers of floriculture to cultivate this charming plant. Some fine specimens of various species of *Zygopetalum* are now beautifully in flower; and the whole of this fine genus is highly deserving of the cultivator's care.

MESSRS. LODDIGES', Hackney. A considerable addition has been made this season to the Orchideæ house of the above gentlemen; it is now completed, and the extreme length from one end to the other is one hundred and fifty feet, and, perhaps we may safely say, that there is not such another edifice so well filled with the plants of this beautiful tribe in Europe, though some collections are fast approaching to it. They have now a good specimen of *Cattleya labiata* finely in flower. *Dendrobium moniliforme*. The fine specimen of this elegant species in the possession of the above gentlemen is now beautifully studded over with its delicate, almost transparent, pink blossoms; these will most probably remain in flower for more than a month, and, according to its usual habits, it will be similarly covered with blossoms in about two months more, for it generally flowers three times in a season; it is a most lovely plant, and we know of none that is more worthy of cultivation. *Dendrobium secundum*, another beautiful species, though with smaller flowers, is now exhibiting its densely covered racemes of pretty pink blossoms in fine perfection at this nursery. There is also a probable new species of *Maxillaria* now in flower, but we think it is scarcely distinguishable from *M. picta alba*. Several other good orchideous plants are now beautifully in flower, and we think we never saw Messrs. Loddiges' orchideous plants look better or more healthy than they do at this time.

MR. LOW'S, Clapton. *Convolvulus pintanthus*. We take this opportunity of correcting a mistake which we quite inadvertently made in our last number, in speaking of a new species of *Convolvulus*; we there called it *C. pintestum*, whereas it should be as above. *Thunbergia lutea*. This is, we believe, a new or very rare species of *Thunbergia*; it bears some resemblance to *T. alata*, except that the colour of the flowers is of a lighter yellow, and there is no dark eye in the centre; it is a tolerably good species, worthy of a place in any collection, and is now in flower at the above nursery. *Clematis cœrulea*. This lovely species is now finely in flower at this nursery, where we believe plants may be procured, and no collection should be without it. We are given to understand, that Mr. Low has recently flowered *Statice arborea*, of which highly valuable plant he has a small stock, but it is at present extremely scarce.

MESSRS. ROLLISONS', Tooting. *Oncidium triquetrum*. This rare and extremely elegant little plant is now flowering in the fine collection of Orchideæ at the above nursery; it seems to possess the true character of an Epiphyte, for it delights in growing on a block of wood, suspended from the roof of the house; the flowers, few in number, are produced on short peduncles, and are of a greenish

white-coloured ground, beautifully and abundantly streaked and marked with reddish purple ; it has a most interesting and pretty appearance when in flower, and recommends itself to a place in every collection. *Epidendrum Skinneri*. This charming plant is again in flower at this nursery, and forms, with its pretty pink blossoms, a most lovely and attractive feature in a collection of Orchideæ. *Octomeria lancifolia*. This is a new species of this genus with lanceolate leaves, out of the centre of which spring the little pale green flowers ; the habit of the plant is certainly not inelegant, but the flowers possess no particular beauty, and it may be cultivated for the sake of variety. *Chorizema Manglesii*. This is a new and exceedingly beautiful species of *Chorizema*, the specific name of which has been appropriately given in honour of Captain Mangles, who first introduced it to notice. The flowers are equal in beauty and somewhat similar in colour to those of *C. ovata*, but the plant is of a much stronger habit, and grows much more freely and luxuriantly. It is now in flower at the above nursery, and from its striking beauty no collection should be without it.

MR. YOUNG'S, Epsom. *Loasa aurantiaca*. This is a new and extremely fine species of *Loasa* ; it is a greenhouse plant of twining habits ; the foliage is large and remarkably beautiful, and the flowers are of a very deep orange colour, and when expanded, are full an inch across, and very handsome ; the habit of the plant is peculiarly graceful and elegant, the flowers are produced in great abundance, and there appears to be a good succession ; it is just in flower at the above nursery, and is a highly interesting and valuable plant, particularly as it produces its fine blossoms at this dull season of the year, and it should be in the possession of every person who delights in the cultivation of greenhouse plants. *Nemophila atomaria*. This is a new species of this interesting genus, and, though not so strikingly beautiful as *N. insignis*, is by no means destitute of interest ; but, we think, is an exceedingly pretty and neat little plant, and is well worthy of cultivation ; the flowers are white and beautifully spotted with blue, and it is now flowering most profusely in the greenhouse of the above nursery. It will most probably prove as hardy as *N. insignis*. A fine specimen of *Clematis Sieboldi* is still in flower at this nursery, and has been for these last three months ; and we feel convinced that we cannot say too much in commendation of this truly beautiful and valuable plant. Mr. Young possesses an excellent stock of it, from a guinea to a guinea and a half a plant.

OPERATIONS FOR DECEMBER.

THERE is little to be done in the flower-garden at this season, consequently our remarks under this head will be necessarily very brief. Beds of bulbs, &c., newly planted during the preceding month or two, will, if strong frosts set in, require to be slightly sheltered; else, as not unfrequently happens, the growth will be seriously injured, if not altogether destroyed. Plants of *Aloysia citriodora*, *Fuchsias* of any kind, *Clianthus puniceus*, and indeed every plant, whether on the border, lawn, or against the wall, that frosts or cutting winds threaten to injure, must have some efficient protection. Walls fired for the purpose of repelling the frost, &c. from acting on hardy greenhouse plants, or others that promise to endure the open air in this country, with slight protection in unusually bad weather, must be carefully heated, or the plants will be liable to injury, arising from overcharging the flues with heat in bad weather, when the wind is very cold and frost very severe; injuries of this description show themselves on the plants, by inducing the young inert buds to swell and many to burst, only to become the victims of the succeeding blasts; also the roots are liable to suffer from the same causes, for if the fire be kept very strong, the whole materials in the neighbourhood of them will become considerably heated, which speedily communicates with the adjoining soil, and destroys any roots that may have made their way through to the face of the wall; for we know from experience, that the young growing roots will make for the face of a wall much in the same manner as they do to the side of a flower-pot. The way to prevent this, is to have the fires excited all day in bad weather, according to the degree of cold; by this, the heat is equally distributed over the whole move of flue, without violently heating one part, before the other is sufficiently warm. When it is only required to warm the flues at night, the safest way is to move the fires early in the afternoon. Another planting of bulbs should be put in to succeed those that have been coming on since October. The greenhouse must be actively attended to in regard to giving air, keeping out frost, &c. Give air on all occasions when the weather will admit; warm the flues just sufficiently to allay prevailing damp, and to keep out the frost. Do not let the atmosphere of the stove fall below 65°, or that of the succulent house below 50°, while that of the greenhouse may come down to 40°. Damp in the propagating house, or frame, must be attentively watched, or it will spread to an alarming extent, particularly if the weather be cloudy and the external atmosphere heavy. Dressing and pruning creepers, roses, and shrubs, of every prunable description, should be duly thought of, and attended to as opportunities offer; besides an overwhelming number of other little matters, due and timely attention to which can only be given by making the best of this and the succeeding month or two.



THIS PAGE IS LOCKED TO FREE MEMBERS
Purchase full membership to immediately unlock this page



Never be without a book!

Forgotten Books Full Membership gives universal access to 797,885 books from our apps and website, across all your devices: tablet, phone, e-reader, laptop and desktop computer

A library in your pocket for \$8.99/month

Continue

*Fair usage policy applies



Pentstemon gentianoides.



THIS PAGE IS LOCKED TO FREE MEMBERS

Purchase full membership to immediately unlock this page

DELVE INTO FANTASY, MAGIC, MYTHOLOGY & FOLKLORE

Forgotten Books'
Full Membership gives
access to 797,885 ancient
and modern, fiction and
non-fiction books.

Continue

*Fair usage policy applies

readily propagated by offsets, and seems to ripen seeds much more freely than *P. Murrayanus*.

Of the native situation we have hitherto been unable to learn anything certain.

We are obliged to the kindness of Messrs. Young, for the sample for the drawing, who we believe can supply young plants.

The generic name is explained in vol. iii., page 265

The specific name is derived from its general resemblance to the genus *Gentiana*.

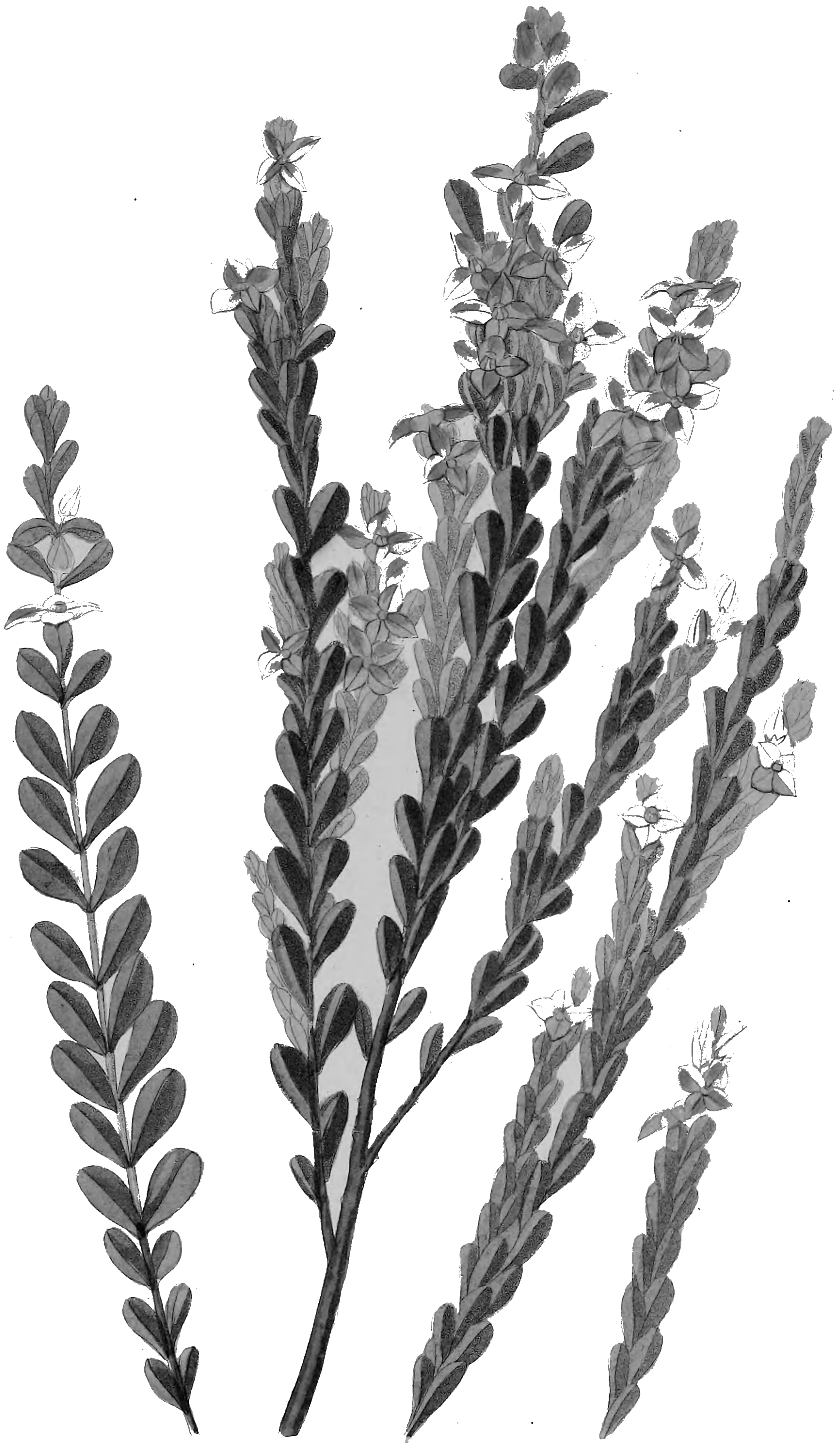

Boronia crenulata.



THIS PAGE IS LOCKED TO FREE MEMBERS
Purchase full membership to immediately unlock this page



Never be without a book!

Forgotten Books Full Membership gives universal access to 797,885 books from our apps and website, across all your devices: tablet, phone, e-reader, laptop and desktop computer

A library in your pocket for \$8.99/month

Continue

*Fair usage policy applies

BORONIA CRENULATA.

(CRENULATE-LEAVED BORONIA.)

CLASS.
OCTANDRIA.ORDER.
MONOGYNIA.NATURAL ORDER.
RUTACEÆ.

GENERIC CHARACTER.—*Calyx* four-parted; or four-cleft, permanent. *Petals* four, marcescent. *Stamens* eight, the four opposite the petals shortest, all shorter than the petals, free, fringed, or tuberculated, linear, usually dilated at the top, whence a very short thread arises, bearing the anther. *Anthers* heart-shaped, usually with a short appendage at the apex. *Styles* four, erect, smooth, approximate or joined together, terminated by an equal or capitate four-furrowed stigma. *Fruit* four two-valved carpels. *Seeds* ovate, compressed, usually one in each carpel.—*Don's Gard. and Botany*.

SPECIFIC CHARACTER.—Plant shrubby, growing from eighteen inches to two feet high (it is however probable that it will ultimately attain as much as three feet in height). *Leaves* of an obovate figure, crenulate, and mucronate. *Peduncles* axillary, terminal, one-flowered. *Flowers* small pinkish, deepening towards the margin. *Calyx* fringed. *Filaments* densely fringed, obtuse, and glandular. *Anthers* nearly terminal.

THE species of *Boronia* already known in our collections have always been great favourites, and justly the admiration of every lover of beautiful plants; it is gratifying indeed to be enabled to add another with nearly equal claims and merits.

We were for some time unable to assign with certainty a name to this beautiful plant when we first saw it in flower, but having shortly after met with the following account from the pen of Sir J. E. Smith, in the Linnæan Society's Transactions, vol. viii. p. 284, we feel satisfied that the name *crenulata* is correct, as is evident from what follows.

“This plant was gathered at King George's Sound, by Mr. Menzies, and at first sight it appears only a variety of *B. serrulata*, but on examination of the flowers sufficient marks of distinction are to be found. Even the leaves differ essentially in being obovate, obtuse with a small point, and *crenulated*, not *serrulated*, about the extremity;” added to this, the filaments are densely fringed, obtuse (by no means inversely heart-shaped, which is so remarkable in *B. serrulata*) see fig. vol. i. t. 173, glandular, scarcely at all bristly, bent and swelling below the top.

The habit of it is very pleasing, the flowers appear near the extremity of the branches, and about the month of May or June they are fully expanded, and continue in tolerable profusion until late in August.

It thrives well with the treatment usually given to the rest of the species, which may be described as follows. In potting, use nice free sandy peat, not over full of fibres, take care to drain well, and always avoid over-shifting. Water at all times with cautious judgment, but more so in winter. Cuttings require active attention, or they will not succeed; they should be clean cut at a joint, and afterwards planted in sand, a glass placed carefully over them, and then set in a frame: air should be admitted now and then, by removing the glass for the escape of vapour, &c.; an excess of moisture, if not checked, will seriously injure if not totally kill them. Young plants may also be obtained from layers if properly managed, which is nothing more than care and skill in the operation. Air and light are so essential to these plants, that they never thrive well if partially supplied with either. They should therefore never be suffered to stand crowded with other plants.

Messrs. Loddiges, to whose kindness we are obliged for the opportunity of publishing it, raised a number of plants from seeds received several years ago from New Holland, and we believe it is only in their possession, of whom it may be purchased; but as it is so scarce, it will undoubtedly be at present rather dear.

The generic name is given in honour of Francis Borone, an Italian servant of Dr. Sibthorp, who perished from an accident at Athens.

The specific name applies to the notches or crenatures in the leaves, which appear like convex teeth.



THIS PAGE IS LOCKED TO FREE MEMBERS

Purchase full membership to immediately unlock this page

DELVE INTO FANTASY, MAGIC, MYTHOLOGY & FOLKLORE

Forgotten Books'
Full Membership gives
access to 797,885 ancient
and modern, fiction and
non-fiction books.

Continue

*Fair usage policy applies



Malva Munroana.



THIS PAGE IS LOCKED TO FREE MEMBERS
Purchase full membership to immediately unlock this page



Never be without a book!

Forgotten Books Full Membership gives universal access to 797,885 books from our apps and website, across all your devices: tablet, phone, e-reader, laptop and desktop computer

A library in your pocket for \$8.99/month

Continue

*Fair usage policy applies

All the species of this genus may be increased by seed, which should be sown, if in the open border, in April; but this species if grown in pots would be as well or better sown a trifle earlier, in a closish nearly cold frame.

Our drawing was made in Mr. Young's Nursery, Epsom, in August 1837. The generic name is a Latin alteration of the Greek, Malake, *soft*, in allusion to the soft mucilaginous qualities of the species. Malva was esteemed an excellent vegetable with the Romans, but what species they made use of is uncertain; one sort of Mallow is used as food by the Chinese.

The specific name is given by Mr. Douglas, in compliment to Mr. Munro, the present very skilful and intelligent gardener to the Horticultural Society.



Zygopetalum flavellarii
Jul.



THIS PAGE IS LOCKED TO FREE MEMBERS

Purchase full membership to immediately unlock this page

DELVE INTO FANTASY, MAGIC, MYTHOLOGY & FOLKLORE

Forgotten Books'
Full Membership gives
access to 797,885 ancient
and modern, fiction and
non-fiction books.

Continue

*Fair usage policy applies

ZYGOPETALUM MAXILLARE.

(TOOTH-LIKE FLOWERED ZYGOPETALUM.)

CLASS.
GYNANDRIA.

ORDER.
MONANDRIA.

NATURAL ORDER
ORCHIDEÆ

GENERIC CHARACTER.—See vol. iii. p. 97.

SPECIFIC CHARACTER.—*Epiphyte*. *Leaves* lanceolate, acuminate, smooth, about a foot in length. *Scape* arising from the base of the bulbs, smooth two-thirds the length of the leaves. *Flowers* racemose, of a beautiful blue, spotted irregularly with dark-brown spots, very handsome. *Petals* and *Sepals* ovate, oblong, acute. *Labellum* (lip) obovate, very broad; on the disk surrounding the column is a fleshy production resembling the lower jaw beset with teeth, which has suggested the name *Maxillar*, tooth-like appearance; relating to the jaw-bone.

ALL the species belonging to this genus are extremely handsome, and have always been favourites in the Orchideæ house. The species *Mackaii*, already figured vol. iii. t. 97, is admired by all for its handsome flowers, peculiar for being large, and for having a very showy lip, which is of a light colour, very broad, and beautifully spotted with purple and blue. In some orchideous collections there are some very showy varieties of this species, differing more or less in the colouring of the flowers; one in particular, called Mrs. Harrison's white variety, is quite remarkable for having a nearly white lip with few spots.

Z. rostratum, although the least showy, is highly curious, and as it flowers frequently in the season, is always an object of great interest and beauty; the flowers are large, and the lip pure white, except a few radiating lines delicately introduced near the base, which look very pretty.

The species now represented has not such large flowers as those adverted to above, nevertheless it is unquestionably the most beautiful and interesting; the deep rich blue colour of the lip, and the bright green chocolate of the sepals, constitute it one of the most delightful objects that now adorn our stoves: it is also remarkable for the length of time the flowers continue perfect; the plan

from which our drawing was taken continued beautifully in flower in the Orchideæ house at Chatsworth for upwards of two months. It is a native of Rio Janeiro, and was sent to the Messrs. Loddiges of the Hackney nursery, by their friend Mr. F. Warre, in 1829.

For particulars on culture, &c., see vol. iii. page 97.

The generic appellation refers to the union of the five petals at the base, and is derived from *Zygos yoke*, and *Petalon petal*.

The specific name, from *Maxillar*, refers to the fleshy teeth-like productions resembling the lower jaw of an animal, surrounding the column: these are quite obviously delineated in the coloured figure



THIS PAGE IS LOCKED TO FREE MEMBERS
Purchase full membership to immediately unlock this page



Never be without a book!

Forgotten Books Full Membership gives universal access to 797,885 books from our apps and website, across all your devices: tablet, phone, e-reader, laptop and desktop computer

A library in your pocket for \$8.99/month

Continue

*Fair usage policy applies

showy plant to the notice of our readers as one of the most splendid embellishments at present known in our collections of stove plants. Plants of it not more than nine inches high, have been in flower at the above nursery nearly three months and still remain so. *Schizopetalum Walkeri*. This is a new annual of no great beauty; the flowers are white, but prettily divided into numerous segments, and it is now flowering abundantly in the greenhouse of this nursery. A fine specimen of *Loasa aurantiaca* is still in flower, and this is a plant of considerable merit.

OPERATIONS FOR JANUARY.

FOR work to be done in the flower-garden &c. this month, we refer to our last number, page 264, where necessary directions will be found, to which we have little to add in this place. Beds of bulbs, to which attention was called last month, should immediately be minutely looked over, and encouraged in every possible way, first by guarding those that require it from severe weather, and in the second place by taking means to destroy all kinds of insects &c. likely to attack them. Mice are not unfrequently great pests among bulbs and various kinds of roots; especially in winter, when provisions grow scarce, they resort in great numbers to seeds newly sown, or bulbs newly planted. There are many means to decoy them, most of which if persevered in will succeed. Dahlias and other roots stored in sand or other material for preservation through the winter, are exposed to injuries arising from damp &c., it is therefore necessary that they be looked over now and then, and timely means adopted to check its increase. Young plants of *Clintonia pulchella* will stand quite safe in the greenhouse near the glass, if the situation be light and airy. The soil best for this handsome though delicate plant should comprise two parts of leaf mould, to which may be added a little well-decomposed manure, and one part good sandy loam; the soil in mixing should be broken down very fine, and the plants put into sixty-sized pots, until they have made some advance, when larger will be necessary. Roses in the forcing-house should be constantly attended to; indeed all shrubs, whether Jasmines, Persian-Lilac, Azaleas, &c., or whatever species of plant intended to flower early by means of artificial heat, should be attended to, liberally watered, and, when necessary, fumigated with tobacco, for they are very often seriously annoyed by green-fly &c., which infest the young shoots to an alarming extent, but perhaps more particularly roses and pinks. Continue to introduce bulbs &c., and a succession of flowers will be secured for the greenhouse. Attend to Amaryllises, and all kinds of stove-roots that are started and starting,—pot and water them, and if necessary place them in an increased heat, and be sure to let them have plenty of light.

INDEX.

A.

ACACIA longifolia, pulchella, with a select list of desirable species, 197, 198
Acacia pubescens, 71
Aconitum versicolor, 191; *Chinense*, 213
 Advantages of striking cuttings in water, 180
Æolian Cytisus, 16
Ærides odorata (cornuta), fine flowering plant of, 118
Agrostemma Bungeana, 7
 Akee Tree, culture of, 60
 Aloes, hints on, 24
 Alonsoa, to be propagated, 24
Alstrœmerias, 157
Altingia excelsa, hints on the management of, 207
Amaryllises, &c. to be attended to, 24
Anagallis Phillipsii, Monelli, 157
Angræcum odoratissimum, 95; *caudatum*, 132
Anigozanthos, perhaps *rufa*, 212
 Annuals, tender, to be sown and attended to, 96, 120, 192; half-hardy, to be sown, 72; hardy, sow full crop, and otherwise attend to them, 72, 96
Anthericum glaucum, 234
Antirrhinum caryophylloides, 165
Aporum anceps, 235; *indivisum*, 236
 Aquatic Plants, a selection of, culture, &c. 107
Arenaria rubra, its presence and indication of sand, 9
Aspasia variegata, 19
 Auriculas, hints respecting, 48, 72, 96
Azalea Indica, variegated, 44, 94; *Indica Smithii*, 94; propagation, 144; *Indica*, 69

B.

BANKSIA occidentalis, 20
Bartonia aurea, 18
 Baxter's Isopogon, 20
 Beech Tree, 158
Begonia octopetala, 68; *Fischeri*, 18; *monoptera*, 89; *odorata*, culture of, 123; *insignis*, 233
 Biennials, to be sown, &c. 72, 96
Bifrenaria flagellifera, 44
Blighia sapida, 60
Blumenbachia multifida, 210

Bog-plants, a selection of, culture, &c., 107
 Bojer's spurge, 17
Bolbophyllum-like *careyanum*, 21; *barbigerum*, interesting notices of, 68, 132, 166; *cocoinum*, 137; *saltatorium*, 164
Boronia crenulata, 267
Brassavola cordata, 20
Brassia Lanceana, 95, 137
Brugmansia suaveolens, remarks on, 87; *Waymannii*, 241
 Bulbs to be attended to, 24, 72, 120, 192
 Bunge's Scarlet Campion, 7
Burlingtonia candida, 42

C.

САСТÆ, hints respecting, 96
Calanthe densiflora, 236; *veratrifolia*, 119
Calceolarias, remarks on, 24, 119, 144, 192
Calliprora lutea, 16
Callionema pulchra, 132
Calochortus venusta luteus, 165
Camellia Doncklaerii, 21, 71; forcing, 24; bicolor, 71; *Hendersonii*, 43; to have them to flower early, 72, 96; cultivation of, as practised by Messrs. Chandlers, Vauxhall, 114
Campanula Scheuchzeri, 190; *Portenschlagiana*, 232
Canadian Desmodium, 66
 Carnations, removing young plants, 48; sowing seed, 96, 192
Catasetum luridum, 45
Cattleya guttata, 21; probable new species, 96, 235; *labiata*, 121, 166, 235; culture, 122, *crispa*, 166; *Harrisoniæ*, 247
Cephalanthus occidentalis, 191
Cereus serpentinus, 89; *senilis*, 213
Ceropegia stapelformis, 89; *elegans*, *bulbosa*, 168
Charlwoodia australis, 44
 Chemical agents of soil, 12
Chimonanthus fragrans, to be layered, 144, 192
 China roses, 96
 Chinese scarlet-flowered Air Plant, 49
Chorizema ovata, culture of, 95, 119, 153, 154; *Henchmannia*, 95, 233
Chrysanthemum Indicum, 96, 168; remarks on the genus, 129
Chryseis compacta, 88

Chysis aurea, 68, 71, 166
 Cinnamon Tree, remarks on, 103
 Cineraria Waterhousiana, 219; cultivation of, 220; Hendersonii, 43
 Cistus speciosus, 213; culture of the genus, 183
 Clarkia guauroides, 90
 Clematis coerulea, 116, 193; azurea grandiflora, 119; Sieboldii, 147, 213
 Cleome centranthifolia, 167
 Clivanthus puniceus, method of training, 21, 134
 Clintonia pulchella, 145; culture, 146, 240
 Cocoa-nut Tree, culture of, 40
 Cold Frames, Pits, &c. hints on, 216
 Collinsia bicolor, 133
 Commelina coelestis, 131
 Convolvulus Pintestum, 236; minor, 190
 Costus speciosus, 245
 Cowania plicata, 211
 Cow Tree, notice of, 128
 Cratogeomys flava; var. lobata, 65; Oxyacantha; var. Oliveriana, 65
 Creepers, attention to, 120, 168
 Cyclamen roots to be turned out, 144
 Cycnoches ventricosum, 190; Loddigesii, 190
 Cyrtanthus, cultivation of the genus, and others, 249
 Cyrtochilum flavescens, 212
 Cyrtopodium Andersonii, 71
 Cytisus racemosus, 118; Æolicus, 16

D.

DALIA roots to be potted, &c., 48; to be protected from frost, 96, 120, 144
 Dancing Bolbophyllum, 164
 Dalmatian Wall-flower, 232
 Datura Guayaquilensis, 90
 Daviesia latifolia, 223; ulicina, cultivation of, 29
 Delicate Ionopsis, 18
 Delphinium tenuissimum, 41; montanum, 67; Barlowii, 88, 167; intermedium; var. pallidum, 163; intermedium; var. coeruleus, 209
 Dendrobium densiflorum, 21; Pierardii, pulchellum, 70; moschatum, &c., 119
 Desmodium Canadense, 66
 Deutzia scabra, culture of, 113, 189
 Dianthus superbus flore plenus, 213
 Dillwynia glycinifolia, 99
 Dipodium punctatum, 189
 Douglas's Limnanthes, 66
 Drosera filiformis, 20
 Drummond's Pink-flowered Vervain, 19
 Drymonium bicolor, 190

E.

ECHEVERIA racemosa, 116
 Echinocactus sessiliflorus, 89; mammillarioides, 67; Mackieanus, 68
 Elegant globe-flowered Fuchsia, 75
 Epacris impressa, 44, 69 126 · variabilis, 69, 126

Epidendrum æmulum, 17; macrochilum, 18; large-lipped, 18; Skinneri, 21; chloroleucum, 68; green and white flowered, 68; bicornutum, 95; Imetrophyllum, 119; elongatum, 119
 Epimedium macranthum, 18
 Epiphyllum speciosum, culture and grafts, 22
 Eria stellata, 234
 Eriobotrya Japonica, culture of, 111
 Ericas, to be propagated, 96, 120
 Eriostemon buxifolium, cuspidatum, 132
 Eucharidium concinnum, 135
 Eulophia cochleata, 21; macrastachya, 164
 Euphorbia fulgens, culture of, 31, 236; Jacquinaeflora, 21; Bojera, 17; punicea, 236
 Eutoca viscida, 165, 235; viscosa, 116
 Evergreens, to be pruned, 168

F.

FLOWER-GARDEN, hints respecting, 216, 240; Plans and ornaments, commencing a series of, 257
 Flower-stand, design for a new one, 59
 Flywort, triangular-lipped, 17
 Ficus stipulata, 227
 Fischer's Begonia, 18
 Food of Plants, 15
 Forcing Pinks, &c., 48
 French and English roses to flower late, 96
 Friability of soil, 11
 Fuchsia macrostema; var. recurvata, 17; large stamened, 17; globosa; var. elegans, 75, 212; Atkinsonia, 190; globosa, 191
 Fuel, economic use of, 57
 —, remarks on, 185

G.

GALARDIA picta, 131
 Garden Architecture, 82
 Gardenia pannea, 115
 Garden Chair, design for, 206
 Genista monosperma, 19, 45; single seeded, 19
 Gesneria oblongata, 22; to be excited, 24; Selloi, 27; faucicaulis, 27; sceptrum; var. ignea, 116; Lindleyi, 210; Douglasii; var. verticillata, 259
 Gloriosa superba, 190
 Gloxinia speciosa, &c. culture of, 127; to be encouraged, 24
 Golden Bartonia, 18
 Golden-flowered Chysis, 68
 Governia pallida, 70
 Grabowskia Boerhaaviaefolia, 209
 Greenhouse Plants, hints respecting, 72; propagation of, 144, 192; additional hints on, 216; a method of arranging during summer, 237; remarks on watering, &c., 240
 Grevillea rosmarinifolia, 47
 Griffin's Lissochilus, 25
 Guayaquil Thorn Apple, 90
 Guara-like Clarkia, 90
 Guavas, culture of red and white, 39



THIS PAGE IS LOCKED TO FREE MEMBERS

Purchase full membership to immediately unlock this page

DELVE INTO FANTASY, MAGIC, MYTHOLOGY & FOLKLORE

Forgotten Books'
Full Membership gives
access to 797,885 ancient
and modern, fiction and
non-fiction books.

Continue

*Fair usage policy applies

Oncidium iridifolium, 19, 95; *leucochilum*, 21, 213.
Oncidium Lanceanum, 21, 95, 133, 166, 169; culture of, 170, 236
Oncidium crispatum, 42; *cebolleti*, 44; *luridum*, 45, 71, 95
Oncidium ampliatum, 45; *lunatum*, 66; *pulchellum pictum*, 70
Oncidium citrinum, 77; *papilio*, 118; *divaricatum*, *altissimum*, 119; *pumillum*, 137; *ornithorhynchum*, 166
Operations for February, 23; March, 48; April, 72; May, 96; June, 120; July, 144; August, 168; September, 192; October, 216; November, 239; December, 264; January, 274
Orange trees, to be started, 72, 144, 192
Orchideæ, cultivation of, as practised by Messrs. Rollinson, Tooting, 45
Orchideæ, shading suitable for, 134
Ornamental plants, to be propagated, 96
Ornithogalum latifolium, 189
Oxalis acetosella, its presence an indication of the presence of iron, 9
Oxalis alba, 210; *Barlerii fruticosa*, 133; *bipartita*, *divergens*, 210
Oxalis versicolor, 44

P.

PANCRATIUM *calathinum*, 53
Passiflora Kermesina, 45, 71; *Loudoniana*, 45
Pavetta Caffra, 136
Pelargonium, cuttings to be put in, &c., 48, 120, 168
Pentstemon heterophyllum, 16; various-leaved, 16; *latifolium*, 21; *breviflorus*, 88; *Scholeri*, 133; *Cobæa*, 165, 243, *Murrayanus*, 167, 213; *gentianoides*, 213, 265
Pereskia aculeata, 64; *Blco*, 70
Peristeria cerina, 117, 132
Petrea Stapelsiæ, 199
Phajus albus, 166
Pharbitis diversifolia, 209
Philbertia gracilis, 234; *grandiflora*, 260
Philadelphus speciosus, 259
Phlox Drummondii, 211; *cordata grandiflora*, 191
Physostegia truncata, 237
Pigmy *Oncidium*, 19
Pinks, to be fumigated, &c., 24; propagation, 120, 144
Pitcher Plant, culture of, 1; contents of pitchers, 3
Pit-coal, 57
Plants, planted out with a view to endure the open air, 120
Plants in pots, and management of cuttings, 225
Platystemon Californicum, 136, 189
Platystigma lineare, 115
Pleiothalis saurocephala, 164
Podolobium staurophyllum, 171
Poinsettia pulcherrima, 97
————— culture of, 98
Polyanthus, seed to be sown, 48; potted, 96, 120
Polygala myrtifolia; *var. grandiflora*, 260

Potentilla Thomasii, 41, 211; *Hopwoodiana*, 211; *formosa*, 191; *Garneriana*, 165
Power of soils, to absorb water from, 11
Primula Sinensis, 21; *venusta*, 188
Productiveness of soils, 11
Psoralea orbicularis, 163

R.

RABBIT Berry, culture of, 106
Ranunculuses, to be planted, 48
Rauch, M. F., on *Euphorbia fulgens*, 32
Rehmannia Chinensis, 135
Remarks on the genus *Hoya*, 13
Renanthera coccinea, 49; culture of, 50
Rhodanthe Manglesii, 94
Rhododendron Cunninghamii, 71; *arborea*, 71, 130; *cinnamomum*, 95; *multimaculatum*, 133; *Phœniceum*; *var. splendens*, 137; *arborea*; *var. cinnamomum*, 188
Rhodora Canadense, 70
Robinia Pseudo-acacia, 143
Rockets, &c., 144, 192
Rondoletia odorata, 21
Rosa lutea; *var. plena*, 16; *Sinica*, 41; *Indica*; *var. Blairi*, 260
Roses, to be fumigated, 24; to be taken up, 144
— forced, 70; budded, 144
Russelia juncea, 79

S.

SACCOLOBIUM *præmorsum*, 94, 119; *guttatum*, 119
Sarcanthus teretifolius, 117
Sarracenia, new species of, noticed, 21
Sceptum-flowered *Gesneria*, 116
Schizopetalon Walkeri, 136
Scottia lævis, 44
Sea-coal, 57
Sedum cœruleum, 132
Sellow's *Gesneria*, 27
Serpent-like *Cereus*, 89
Shepherdia argentea, culture of, 106
Short-spurred *Tropæolum*, 41
Shrubs, forcing of, 24
Siebold's *Clematis*, 147
Silene chloræfolia, 209
Silphium terebinthaceum, 17
Single-winged *Begonia*, 89
Sinningia villosa, 190
Siphocampylos bicolor, 163, 195
Snow-white *Burlingtonia*, 42
Soils, improved by pulverisation, 12
— definite appropriate terms indispensable, 228
Souls, admission of air &c. tends to improve, 12
— improved by adding to, 13
— effects of burning, 13
— prepare, 24
Solanum Herbertia, 119
Sopronitis cernua, 236
Sparmannia Africana, culture of, 204
Spartium acutifolium, 163
— *junceum*; *var. odoratissimum*, 163

Speckled Nemophila, 67
 Splendid Rose-bay, 137
 Spiræa Japonica, 166
 Stanhopea insignis, 165
 —, oculata, eburnea, 165
 Stapelia, culture of the genus, 92
 Stapelia-like Ceropogia, 89
 Statice arborea, 217
 — conspicua, 218
 — sinuata, 218
 — spathulata, 218
 — speciosa, 218
 Steel's Maxillaria, 117
 Stocks &c., noticed, 240
 Stove plants, propagation of, 120
 — — to be potted, 72; notice on, 240
 Stranvæsia glaucescens, 116
 Streptocarpus Rexii, 81
 Succulents, to be propagated, 72
 Sundew, narrow-leaved, 20
 Sisyrinchium grandiflorum, 71, 137; graminifolium; *var.* pumilum, 20

T.

TECOMA Jasminoides, 259
 Telfairia pedata, 230
 Tenacity of soils, arising from, 10
 Tender annuals to be sown, 48
 Terebinthine Silphium, 17
 Testudinaria elephantipes, 21, 190
 Thibaudia, hints on the genus, &c., 253
 Thomas's Cinquefoil, 41
 Three-leaved China Rose, 41
 Tigridia Pavonia, to be sown, &c. 48
 Tradescantia caricifolia, 43
 Trichocentrum fuscum, 90, 236
 Trigonidium obtusum, 42
 Tritelaria uniflora, 43
 Tropæolum brachyceras, 41, 55; tricolorum, 237
 Tropæolum tuberosum, 236
 Tuberoses, to be encouraged, 120
 — to be planted, 72
 Tulbaghia violacea, 66
 Tulips, to be examined, 48

Tussilago Farfara, its presence an indication of blue clay, 9
 Tweedie's Scarlet Vervain, 5, 19
 Tweedia coerulea, 260

U.

UPON the supposed absorbent powers of the cellular points, or spongioles of the roots of trees, and other plants, 184
 Uses of earths, 10

V.

VANDA tessellata, or Roxburghii, 190
 Variegated Aspasia, 19
 Verbena Tweediana, 5, 19, 168, 192; pulchella alba, 167
 Verbena chamædrifolia, 167; Drummondi, 168
 — Lambertia; *var.* rosea, 19; remarks on, 216
 Veronica perfoliata, 65
 Vesicaria gracilis, 18; slender-stemmed, 18

W.

WAXEN Dove-flower, 117
 West-coast Banksia, 20
 West Indian gooseberry, 64
 White Lily, narrow-sepaled, 42
 Wigandia Caraccasana, 136
 Wistaria consequana, mode of training it, &c. 135

X.

XANTHOSIA rotundifolia, 136

Z.

ZYGOPETALUM cochleata, 166
 — maxillare, 166, 271

XXXX
 (6)





THIS PAGE IS LOCKED TO FREE MEMBERS
Purchase full membership to immediately unlock this page



Never be without a book!

Forgotten Books Full Membership gives universal access to 797,885 books from our apps and website, across all your devices: tablet, phone, e-reader, laptop and desktop computer

A library in your pocket for \$8.99/month

Continue

*Fair usage policy applies