



PLC
+HMI
ALL IN ONE™

Powerful Software

Outstanding Support

Complete Range of PLCs

VISION
SAMBA
JAZZ



Powerful Software

Single, intuitive, feature-rich programming environment & utilities suite

Unitronics provides a powerful solution; our software is more than a match for any requirement. Hardware configuration, HMI design and communications are all programmed in an single, intuitive software environment, which includes a extensive utilities suite with DataExport, Remote Access and more. This all-in-one approach reduces the time and effort needed to program a unit. Not only is our software user-friendly, all of Unitronics software and utilities are provided at no extra cost.

Outstanding Support

Expert support without fees or tiers

“The support, both via telephone, email and the Unitronics forum, is among the best in the industry” says Jose Padro, President of Alpha Systems, Inc. Unitronics offers best-of-breed technical support to every user without added fees, tiers, or hoops to jump through. Every question we receive is answered by an experienced member of our support team. The same team of experts is available at every step of the project.

About Unitronics



Complete Range of PLCs

A range of product lines to match your exact requirements

With 25 years of experience in automation, Unitronics has established several PLC lines with options to meet a diverse range of requirements. Our R&D strategy is to stay close to the market; we listen to our customer's current needs and future plans and develop new solutions accordingly. This strategy enables us to offer simple tried-and-true solutions alongside cutting edge innovations.

PLC
+ HMI
ALL IN ONE™

Unitronics designs, manufactures, and markets quality PLCs for the global market. Easy to use, efficient, and affordable, our products have been automating processes, systems, and stand-alone applications since 1989.

We maintain more than 160 distributors in over 55 countries around the globe, enabling our customers to purchase our products with local marketing support. Unitronics' field-proven PLCs automate hundreds of thousands of installations in diverse fields: petrochemical, automotive, food processing, plastic & textile, energy & environment, water & waste water management - anywhere automated processes are required.

Download Unitronics' App:



Table of Contents	Page
Integrated Programming Environment.....	6
Utilities.....	7
Vision 1210 / 1040.....	8
Vision 700.....	10
Vision 570J / 570 / 560.....	12
Vision 430.....	14
Vision 350J / 350.....	16
Vision 130J / 130.....	18
Vision 120.....	20
Vision 200.....	21
SAMBA.....	22
JAZZ.....	24
M91	26
I/O Expansion Modules	28
Snap-in I/O Modules	29
Network Configuration	30

Powerful software – included with your All-in-One package

A single, intuitive environment for all of your application needs



Hardware Configuration

Intuitive set up: controller, I/Os, and COM channels

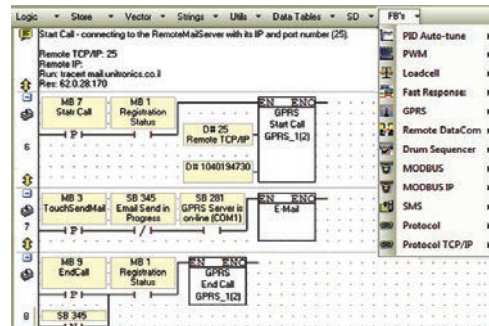

Ladder Programming

Rapidly drag & drop elements and Function Blocks

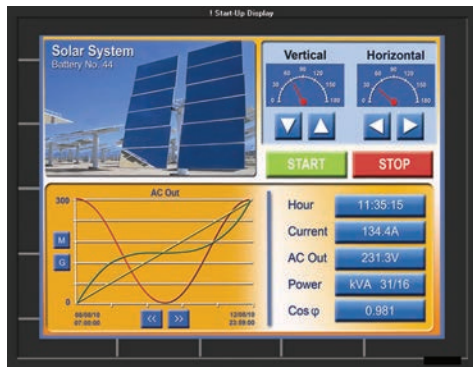

HMI Application

Create beautiful HMI displays – includes rich image library

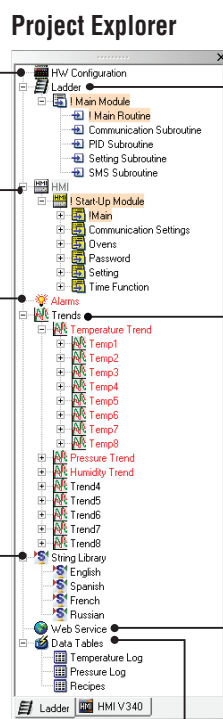

Project Explorer



Trend Graphs

Display dynamic values in real-time



Alarms: Built-in Screens

Effectively alert staff via Alarm screens

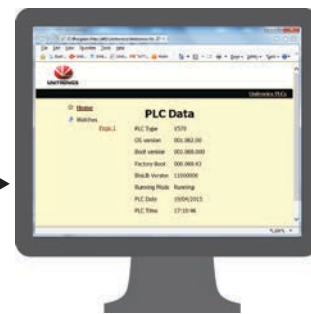

Web Server

Display and edit application values via browser

Languages - String Library

Instantly switch HMI language via screen touch

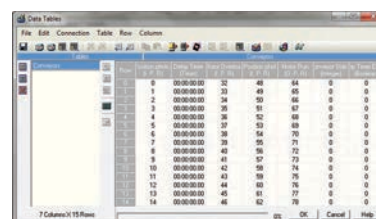







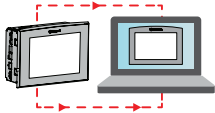

Data Tables

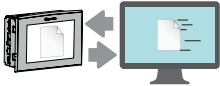
Create logs, import/export data, implement recipes

Software features vary according to controller model

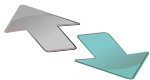
Smart Utilities – Remote Access, Efficient Data Management and more

Utility Name	Function	Key Features	Targeted Users
Remote Access 	View and control a PLC directly from PC, via local or remote connection	<ul style="list-style-type: none"> View an HMI panel; use the PC keyboard + mouse to run the HMI application Operand and Data Table values: view values during runtime, import and export values to/from Excel/.csv files 	<ul style="list-style-type: none"> Operators requiring Remote Access System integrators: remote debugging, troubleshooting, fault-finding
Remote Operator 	Simultaneously view and operate the HMI panels of multiple PLCs in multiple locations	<ul style="list-style-type: none"> Easily place HMI panels side-by-side to monitor distributed systems, or applications in several locations Run the HMI applications via PC keyboard + mouse 	<ul style="list-style-type: none"> Control room operators Installation Managers
DataXport 	Create Data Logs from Data Tables and operand values in PLCs	<ul style="list-style-type: none"> Harvest data from multiple PLCs - on demand or according to time/date Export the data to Excel/CSV files Automatically email files 	<ul style="list-style-type: none"> Data analysts Plant managers Process engineers
UniDownload Designer 	Create compressed VisiLogic / U90Ladder applications(.udc files) for secure installation in local or remote PLCs	<ul style="list-style-type: none"> Prevent end-users from uploading and opening the application Include an OS to be installed at download Set a Download channel, restrict end-user actions after installation and more 	OEMs / System Integrators can: <ul style="list-style-type: none"> Protect source code. Enable customers to install an application without using VisiLogic or U90Ladder
Download Manager & UniDownloader 	Securely install .udc applications in local or remote PLCs	<ul style="list-style-type: none"> Download Manager: installs the same application in multiple PLCs UniDownloader: installs an application in a single PLC 	<ul style="list-style-type: none"> OEMs / System Integrators in installations with high security requirements
SD Card Suite 	Remotely access and manage SD cards and their data	<ul style="list-style-type: none"> Browse a remote PLC's SD card. Read/write data, including Data Table files View SD card contents - Trends, logs, alarm history, data tables - export to Excel 	<ul style="list-style-type: none"> Data analysts Plant managers Process engineers
UniVision Licensing 	Safeguard your PLC application security	<ul style="list-style-type: none"> Embeds unique licenses in the PLC, which enables application to run only on a licensed PLC Option to activate or deactivate different sections of your application Prevents theft of applications 	<ul style="list-style-type: none"> System integrators OEMs
UniOPC Server 	Exchange data between Unitronics PLCs and OPC-supported software	<ul style="list-style-type: none"> Create channel to connect PLCs to SCADA systems, such as plant control rooms Compliant with the OPC foundation standards 	Control room operators
UniDDE 	Exchange data with Windows based applications	Enables data exchange between Unitronics PLC's and software that supports Microsoft's Dynamic Data Exchange protocols, like Excel.	Control rooms operators
Programming tools for developers 	Easily implement communication between PLC & PC applications	Using ActiveX & .NET communication drivers	Developers

VISION 1210™ /1040™

Advanced PLC from the back-bay & high resolution color touchscreen from the front, 12.1" /10.4". Snap-in I/Os for an All-in-One; expand up to 1000 I/Os

Features:

HMI

- Up to 1024 user-designed screens
- 1500 images per application
- HMI graphs - color-code Trends
- Built-in alarm screens
- Text String Library - easy localization
- Memory and communication monitoring via HMI - No PC needed

PLC

- I/O options include high-speed, temperature & weight measurement
- Auto-tune PID, up to 24 independent loops
- Recipe programs and datalogging via Data Tables
- Micro SD card - log, backup, clone & more
- Date & Time-based control

Communication

- TCP/IP via Ethernet
- Web server: Use built-in HTML pages, or design complex pages to view and edit PLC data via the Internet
- Send e-mail function
- SMS messaging
- GPRS/GSM
- Remote Access utilities
- MODBUS protocol support
- BACnet, KNX, M-bus – via 3rd-party converter
- CANbus: CANopen, UniCAN, SAE J1939 and more
- DF1 Slave
- SNMP agent V1
- FB Protocol Utility: enables serial or TCP/IP communications with 3rd-party device; barcode readers, frequency converters, etc.
- Ports: supplied with 2 isolated RS232/RS485, 1 CANbus, 1 USB programming port; 1 port may be added for serial/Ethernet



V1210
Flat Panel



V1040
Classic Panel



“I’ve not yet encountered a job that a Unitronics PLC was unable to cover.”

Timothy Moulder,
Engineer at Black & Decker



Snap-in I/O

Plug a Snap-in module directly into the back of a Vision PLC.

Compatible with all V200, V500, V1040 and V1210 Vision series models.

	V1040	V1210
Article Number	V1040-T20B	V1210-T20BJ
I/O Options	<p>Snap-in I/O Modules Plug these modules directly into the back of the Vision unit to create a self-contained PLC with up to 62 I/Os. Inputs may include Digital, Analog and Temperature Measurement. Outputs may include Transistor, Relay or Analog (sold separately).</p> <p>I/O Expansion Local or Remote I/Os may be added via expansion port or via CANbus. Expand up to 1000 I/Os. (See I/O Expansion Modules- page 28)</p>	
Program	<p>Application Memory Application Logic: 2MB • Images: 40MB • Fonts: 1MB</p> <p>Scan Time 9µsec per 1K of typical application</p> <p>Memory Operands 8192 coils, 4096 registers, 512 long integers (32 bit), 256 double words (32 bit unsigned), 64 floats, 384 timers (32 bit), 32 counters Additional non-retainable operands: 1024 X-bits, 512 X-integers, 256 X-long integers, 64 X-double words</p> <p>Data Tables 120K dynamic RAM data (recipe parameters, datalogs, etc.), up to 256K fixed data</p> <p>SD Card (Micro) Store datalogs, Alarm History, Data Tables, Trend data, export to Excel • Back up Ladder, HMI & OS, clone PLCs</p> <p>USB 1 USB programming port (Mini-B)</p> <p>Enhanced Features Trends: graph any value and display on HMI • Built-in Alarm management system • String Library: instantly switch HMI language</p>	
Operator Panel	<p>Type TFT LCD</p> <p>Display Backlight Illumination White LED</p> <p>Colors 65,536 colors, 16-bit resolution • Brightness - Adjustable via touchscreen or software</p> <p>Display Resolution & Size 800 x 600 pixels (SVGA), 10.4" 800 x 600 pixels (SVGA), 12.1"</p> <p>Touchscreen Resistive, Analog</p> <p>Keys 9 programmable function keys Virtual Keyboard</p>	
General	<p>Power Supply 12/24VDC</p> <p>Battery 7 years typical at 25°C, battery back-up for all memory sections and RTC</p> <p>Clock Real-time clock functions (date and time)</p> <p>Environment IP65/NEMA4X (when panel mounted) IP66/IP65/NEMA4X (when panel mounted)</p> <p>Standard CE, UL Many of our products are also UL Class 1 Div 2 and GOST certified - please contact Unitronics</p>	

VISION 700™

Advanced PLC from the back - big & high resolution color 7" touchscreen from the front. Snap-in I/Os for an All-in-One; expand up to 1000 I/Os

Features:

HMI

- Up to 1024 user-designed screens
- 1500 images per application
- HMI graphs - color-code Trends
- Built-in alarm screens
- Text String Library - easy localization
- Memory and communication monitoring via HMI - No PC needed

PLC

- I/O options include high-speed, temperature & weight measurement
- Auto-tune PID, up to 24 independent loops
- Recipe programs and datalogging via Data Tables
- SD card - log, backup, clone & more
- Date & Time-based control

Communication

- TCP/IP via Ethernet
- Web server: Use built-in HTML pages, or design complex pages to view and edit PLC data via the Internet
- Send e-mail function
- SMS messaging
- GPRS/GSM
- Remote Access utilities
- MODBUS protocol support
- BACnet, KNX, M-bus – via 3rd-party converter
- CANbus: CANopen, UniCAN, SAE J1939, and more
- DF1 Slave
- SNMP Agent V1
- FB Protocol Utility: enables serial or TCP/IP communications with 3rd-party device; barcode readers, frequency converters, etc.
- Ports: supplied with mini-USB programming port, 1 RS232/RS485 and 1 Ethernet port. 1 ports may be added: 1 Serial/Ethernet/Profibus and 1 CANbus

Vision700™ has Ethernet port onboard, that supports 8 sockets, enabling to communicate with 8 devices simultaneously.



V700



“Reliability, ease of use, connectivity and competitive prices are Unitronics’ main strengths.”

Mr. Andrea Della Bosca,
EV srl

	V700
Article Number	V700-T20BJ
I/O Options	
Snap-in I/O Modules	Plug these modules directly into the back of the Vision unit to create a self-contained PLC with up to 62 I/Os. Inputs may include Digital, Analog, and Temperature measurement. Outputs may include Transistor, Relay, or Analog. (sold separately)
I/O Expansion	Local or Remote I/Os may be added via expansion port or via CANbus (See I/O Expansion Modules- page 28)
Program	
Application Memory	Application Logic: 2MB • Images: 40MB • Fonts: 1MB
Scan Time	9µsec per 1K of typical application
Memory Operands	8192 coils, 4096 registers, 512 long integers (32-bit), 256 double words (32-bit unsigned), 64 floats, 384 timers (32-bit), 32 counters. Additional non-retainable operands: 1024 X-bits, 512 X-integers, 256 X-long integers, 64 X-double words
Data Tables	120K dynamic RAM data (recipe parameters, datalogs, etc.), up to 256K fixed data
SD Card	Store datalogs, Alarm History, Data Tables, Trend data, export to Excel • Back up Ladder, HMI & OS, clone PLCs
Enhanced Features	Trends: graph any value and display on HMI • Built-in Alarm management system • String Library: instantly switch HMI language
Operator Panel	
Type	TFT LCD
Display Backlight Illumination	White LED
Colors	65,536 colors, 16 bit resolution • Brightness - Adjustable via touchscreen or software
Display Resolution & Size	800 x 480 pixels, 7"
Touchscreen	Resistive, Analog
Keys	Virtual Keyboard
General	
Power Supply	12/24VDC
Battery	7 years typical at 25°C, battery back-up for all memory sections and RTC
Clock	Real-time clock functions (date and time)
Environment	IP66/IP65/NEMA4X (when panel mounted)
Standard	CE, UL Many of our products are also UL Class 1 Div 2 and GOST certified - please contact Unitronics

VISION 570™ /560™

Advanced PLC from the back-big & high resolution color 5.7" touchscreen from the front. Snap-in I/Os for an All-in-One; expand up to 1000 I/Os

Features:

HMI

- Up to 1024 user-designed screens
- 1000 images per application
- HMI graphs - color-code Trends
- Built-in alarm screens
- Text String Library - easy localization
- Memory and communication monitoring via HMI - No PC needed

PLC

- I/O options include high-speed, temperature & weight measurement
- Auto-tune PID, up to 24 independent loops
- Recipe programs and datalogging via Data Tables
- SD card - log, backup, clone & more
- Date & Time-based control

Communication

- TCP/IP via Ethernet
- Web server: Use built-in HTML pages, or design complex pages to view and edit PLC data via the Internet
- Send e-mail function
- SMS messaging
- GPRS/GSM
- Remote Access utilities
- MODBUS protocol support
- BACnet, KNX, M-bus – via 3rd-party converter
- CANbus: CANopen, UniCAN, SAE J1939 and more
- DF1 Slave
- SNMP Agent V1
- FB Protocol Utility: enables serial or TCP/IP communications with 3rd-party device; barcode readers, frequency converters, etc.
- Ports: supplied with 2 isolated RS232/RS485 and 1 CANbus; In Vision570: 1 USB programming port; 1 port may be added for serial/Ethernet



V570
Flat Panel



V570
Classic Panel

“ For a first time user, I had a great experience. I look forward to incorporating this brand of product on future jobs. ”

Jeremy Charles Keene,
Controls Manager at General Broach Company



V560



	V570		V560
Article Number	V570-57-T20B	V570-57-T20B-J	V560-T25B*
I/O Options			
Snap-in I/O Modules	Plug these modules directly into the back of the Vision unit to create a self-contained PLC with up to 62 I/Os. Inputs may include Digital, Analog, and Temperature measurement. Outputs may include Transistor, Relay, or Analog. (sold separately)		
I/O Expansion	Local or Remote I/Os may be added via expansion port or via CANbus. Expand up to 1000 I/Os (See I/O Expansion Modules- page 28)		
Program			
Application Memory	Application Logic: 2MB • Images: 16MB • Fonts: 1MB		
Scan Time	9µsec per 1K of typical application		
Memory Operands	8192 coils, 4096 registers, 512 long integers (32-bit), 256 double words (32-bit unsigned), 64 floats, 384 timers (32-bit), 32 counters. Additional non-retainable operands: 1024 X-bits, 512 X-integers, 256 X-long integers, 64 X-double words		
Data Tables	120K dynamic RAM data (recipe parameters, datalogs, etc.), up to 256K fixed data		
SD Card	Store datalogs, Alarm History, Data Tables, Trend data, export to Excel • Back up Ladder, HMI & OS, clone PLCs		
Enhanced Features	Trends: graph any value and display on HMI • Built-in Alarm management system • String Library: instantly switch HMI language		
Operator Panel			
Type	TFT LCD		
Display Backlight Illumination	White LED		
Colors	65,536 colors, 16 bit resolution • Brightness - Adjustable via touchscreen or software		
Display Resolution & Size	320 x 240 pixels (QVGA), 5.7"		
Touchscreen	Resistive, Analog		
Keys	Virtual Keyboard	24 programmable keys. Labeling options – function keys or customized	
General			
Power Supply	12/24VDC		
Battery	7 years typical at 25°C, battery back-up for all memory sections and RTC		
Clock	Real-time clock functions (date and time)		
Environment	IP65/NEMA4X (when panel mounted)	IP66/IP65/NEMA4X (when panel mounted)	IP65/NEMA4X (when panel mounted)
Standard	CE, UL Many of our products are also UL Class 1 Div 2 and GOST certified - please contact Unitronics		

* Not yet UL certified

VISION 430™

Advanced PLC integrated with a 4.3" wide aspect color touchscreen. Includes an onboard I/O configuration; expand up to 512 I/Os

Features:

HMI

- 1024 user-designed screens and 1000 images per application
- HMI graphs - color-code Trends
- Built-in alarm screens
- Text String Library - easy localization
- Memory and communication monitoring via HMI - No PC needed

PLC

- I/O options include high-speed, temperature & weight measurement
- Auto-tune PID, up to 24 independent loops
- Recipe programs and datalogging via Data Tables
- Micro SD card - log, backup, clone & more
- Date & Time-based control

Communication

- TCP/IP via Ethernet
- Web server: Use built-in HTML pages, or design complex pages to view and edit PLC data via the Internet
- Send e-mail function
- SMS messaging
- GPRS/GSM
- Remote Access utilities
- MODBUS protocol support
- BACnet, KNX, M-bus – via 3rd-party converter
- CANbus: CANopen, UniCAN, SAE J1939 and more
- DF1 Slave
- SNMP Agent V1
- FB Protocol Utility: enables serial or TCP/IP communications with 3rd-party device; barcode readers, frequency converters, etc.
- Ports: supplied with mini-USB programming port and 1 RS232/RS485 ; 2 ports may be added: 1 Serial/Ethernet/Profibus and 1 CANbus



V430



“The huge advantage of this PLC was that - with everything built-in - the communications and use of tags in the HMI was so simple and intuitive.”

Ashley Parr,
HPS

Article	Summary	Inputs ¹				Outputs				Operating voltage
		Digital ²	HSC/Shaft-encoder ²	Analog	Temperature Measurement	Transistor ³	PWM/HSO ³	Relay	Analog	
V430-J-B1	No onboard I/Os	None	None	None	None	None	None	None	None	12/24VDC
V430-J-RH2	10 Digital, 2 D/A Inputs ¹ 6 Relay Outputs	12	3 200kHz, 32-bit	2 0-10V, 0-20mA, 4-20mA 10-bit	None	None	None	6	None	24VDC
V430-J-R34	20 Digital, 2 D/A Inputs ¹ 12 Relay Outputs	22	3 30kHz, 32-bit	2 0-10V, 0-20mA, 4-20mA 10-bit	None	None	None	12	None	24VDC
V430-J-TR34	20 Digital, 2 D/A Inputs ¹ 8 Relay, 4 High-speed Transistor Outputs	22	3 200kHz, 32-bit	2 0-10V, 0-20mA, 4-20mA 10-bit	None	4 npn	4 (3 PTO) 200 kHz max	8	None	24VDC
V430-J-RH6	6 Digital, 2 D/A ¹ , 4 Analog Inputs 6 Relay Outputs	8	1 200kHz, 32-bit	2 0-10V, 0-20mA, 4-20mA and 4 0-20mA, 4-20mA 10-bit	None	None	None	6	None	24VDC
V430-J-RA22	8 Digital, 2 D/A, 2 TC/PT100/ Digital ¹ Inputs 8 Relay, 2 Analog Outputs	12	1 30kHz, 32-bit	2 0-10V, 0-20mA, 4-20mA 14-bit	2 Thermocouple, PT100	None	None	8	2 0-10V, 4 -20mA 12-bit	24VDC
V430-J-TRA22	8 Digital, 2 D/A, 2 TC/PT100/ Digital ¹ Inputs 4 Relay, 2 Analog, 4 High-Speed Transistor Outputs	12	1 200kHz, 32-bit	2 0-10V, 0-20mA, 4-20mA 14-bit	2 Thermocouple, PT100	4 npn	4 (2 PTO) 200 kHz max	4	2 0-10V, 4 -20mA 12-bit	24VDC
V430-J-T2	10 Digital, 2 D/A Inputs ¹ 12 Transistor Outputs	12	3 30kHz, 32-bit	2 0-10V, 0-20mA, 4-20mA 10-bit	None	12 pnp	7 0.5kHz	None	None	24VDC
V430-J-T38	20 Digital, 2 D/A Inputs ¹ , 16 Transistor Outputs	22	2 30kHz, 32-bit	2 0-10V, 0-20mA, 4-20mA 10-bit	None	16 pnp	7 0.5kHz	None	None	24VDC
V430-J-TA24	8 Digital, 2 D/A, 2 TC/PT100/ Digital ¹ Inputs 10 Transistor, 2 Analog Outputs	12	1 30kHz, 32-bit	2 0-10V, 0-20mA, 4-20mA 14-bit	2 Thermocouple, PT100	10 pnp	5 0.5kHz	None	2 0-10V, 4 -20mA 12-bit	24VDC

Product Details

I/O Expansion	Local or Remote I/Os may be added via expansion port or via CANbus. Expand up to 512 I/Os (See I/O Expansion Modules- page 28)
Program	Application Logic: 512K • Images: 12MB • Fonts: 1MB
Application Memory	15µ sec per 1K of typical application
Scan Time	8192 coils, 4096 registers, 512 long integers (32-bit), 256 double words (32-bit unsigned), 64 floats, 384 timers (32-bit), 32 counters Additional non-retainable operands: 1024 X-bits, 512 X-integers, 256 X-long integers, 64 X-double words
Memory Operands	120K dynamic RAM data (recipe parameters, datalogs, etc.), up to 256K fixed data
Data Tables	Store datalogs, Alarm History, Data Tables, Trend data, export to Excel • Back up Ladder, HMI & OS, clone PLCs
SD Card (Micro)	Enhanced Features
Enhanced Features	Trends: graph any value and display on HMI • String Library: instantly switch HMI language
Operator Panel	
Type	TFT LCD • 65,536 colors, 16-bit resolution • Brightness - Adjustable via touchscreen or software
Display	Resolution: 480x272 pixels • Size: 4.3"
Touchscreen	Resistive, Analog
Keys	5 programmable keys.
General	
Power Supply	24VDC, except for V430-J-B1, which is 12/24VDC
Battery	7 years typical at 25°C, battery back-up for all memory sections and RTC
Clock	Real-time clock functions (date and time)
Environment	IP66/IP65/NEMA4X (when panel mounted)
Standard	CE, UL Many of our products are also UL Class 1 Div 2 and GOST certified - please contact Unitronics

¹ In some models certain inputs are adaptable via wiring and software settings, and can function as digital, high-speed, analog, and in certain models as TC or PT100. Adapting requires input pins. This reduces the number of digital inputs. Pin requirements:

- Each high-speed requires 1 or 2 pins according to high-speed mode.
- Each analog input requires 1 pin.
- Each TC requires 2 pins per TC input
- The first PT input requires 3 pins, and two additional pins for each additional PT input.

Example: V430-J-RA22 offers 12 digital inputs. Implementing 2 TC inputs requires 4 pins, leaving 8 pins free. Implementing 2 PT inputs uses 5 input pins.

² The total number of digital inputs listed includes high-speed and adaptable inputs.

³ The total number of digital outputs listed includes high-speed outputs.

VISION 350™

Advanced PLC integrated with a 3.5" color touchscreen. Includes an onboard I/O configuration; expand up to 512 I/Os

Features:

HMI

- 1024 user-designed screens
- 500 images per application
- HMI graphs - color-code Trends
- Built-in alarm screens
- Text String Library - easy localization
- Memory and communication monitoring via HMI - No PC needed

PLC

- I/O options include high-speed, temperature & weight measurement
- Auto-tune PID, up to 24 independent loops
- Recipe programs and datalogging via Data Tables
- Micro SD card - log, backup, clone & more
- Date & Time-based control

Communication

- TCP/IP via Ethernet
- Web server: Use built-in HTML pages, or design complex pages to view and edit PLC data via the Internet
- Send e-mail function
- SMS messaging
- GPRS/GSM
- Remote Access utilities
- MODBUS protocol support
- BACnet, KNX, M-bus – via 3rd-party converter
- CANbus: CANopen, UniCAN, SAE J1939 and more
- DF1 Slave
- SNMP Agent V1
- FB Protocol Utility: enables serial or TCP/IP communications with 3rd-party device; barcode readers, frequency converters, etc.
- Ports: supplied with mini-USB programming port and 1 RS232/RS485; 2 ports may be added: 1 Serial/Ethernet/Profibus and 1 CANbus



V350-J
Flat Panel



V350
Classic Panel



NEW! Extended temperature range unit, operational temperature between -30°C to 60°C.
Available with classic or flat panel design
Extended temperature options also available for Ethernet and CANBus cards.

Classic panel p/n: V350-S-TA24, Flat panel p/n: V350-JS-TA24, CANBus p/n: V100-S-CAN Ethernet p/n V100-S-ET2

“ There were significant cost savings using the Unitronics PLC. ”



Justin Butler,
Senior Electrical Engineer at Energy Plant Solutions

Vision350™ models - Onboard I/Os

		Inputs ¹					Outputs				Operating voltage
Article	Summary	Digital ²	HSC/Shaft-encoder ²	Analog	Temperature Measurement	Transistor ³	PWM/HSO ³	Relay	Analog		
V350-J-B1	V350-35-B1	No onboard I/Os	None	None	None	None	None	None	None	None	12/24VDC
V350-J-TR20	V350-35-TR20	10 Digital, 2 D/A Inputs ¹ 6 Relay Outputs 2 High-speed Transistor Outputs	12	3 200kHz, 32-bit	2 0-10V, 0-20mA, 4-20mA 10-bit	None	2 npn	2 (2 PTO) 200 kHz max	6	None	24VDC
V350-J-R34	V350-35-R34	20 Digital, 2 D/A Inputs ¹ 12 Relay Outputs	22	3 30kHz, 32-bit	2 0-10V, 0-20mA, 4-20mA 10-bit	None	None	None	12	None	24VDC
V350-J-TR34	V350-35-TR34	20 Digital, 2 D/A Inputs ¹ 8 Relay, 4 High-speed Transistor Outputs	22	3 200kHz, 32-bit	2 0-10V, 0-20mA, 4-20mA 10-bit	None	4 npn	4 (3 PTO) 200 kHz max	8	None	24VDC
V350-J-TR6	V350-35-TR6	6 Digital, 2 D/A ¹ , 4 Analog Inputs 6 Relay Outputs 2 High-speed Transistor Outputs	8	1 200kHz, 32-bit	2 0-10V, 0-20mA, 4-20mA and 4 0-20mA, 4-20mA 10-bit	None	2 npn	2 (2 PTO) 200 kHz max	6	None	24VDC
V350-J-RA22	V350-35-RA22	8 Digital, 2 D/A, 2 TC/PT100/ Digital ¹ Inputs 8 Relay, 2 Analog Outputs	12	1 30kHz, 32-bit	2 0-10V, 0-20mA, 4-20mA 14-bit	2 Thermocouple, PT100	None	None	8	2 0-10V, 4-20mA 12-bit	24VDC
V350-J-TRA22	V350-35-TRA22	8 Digital, 2 D/A, 2 TC/PT100/ Digital ¹ Inputs 4 Relay, 2 Analog, 4 High-Speed Transistor Outputs	12	1 200kHz, 32-bit	2 0-10V, 0-20mA, 4-20mA 14-bit	2 Thermocouple, PT100	4 npn	4 (2 PTO) 200 kHz max	4	2 0-10V, 4-20mA 12-bit	24VDC
V350-J-T2	V350-35-T2	10 Digital, 2 D/A Inputs ¹ 12 Transistor Outputs	12	3 30kHz, 32-bit	2 0-10V, 0-20mA, 4-20mA 10-bit	None	12 pnp	7 0.5kHz	None	None	24VDC
V350-J-T38	V350-35-T38	20 Digital, 2 D/A Inputs ¹ , 16 Transistor Outputs	22	2 30kHz, 32-bit	2 0-10V, 0-20mA, 4-20mA 10-bit	None	16 pnp	7 0.5kHz	None	None	24VDC
V350-J-TA24 V350-S-TA24	V350-35-TA24 V350-JS-TA24	8 Digital, 2 D/A, 2 TC/PT100/ Digital ¹ Inputs 10 Transistor, 2 Analog Outputs	12	1 30kHz, 32-bit	2 0-10V, 0-20mA, 4-20mA 14-bit	2 Thermocouple, PT100	10 pnp	5 0.5kHz	None	2 0-10V, 4-20mA 12-bit	24VDC

Product Details

I/O Expansion	Local or Remote I/Os may be added via expansion port or via CANbus. Expand up to 512 I/Os (See I/O Expansion Modules- page 28)
Program	Application Logic: 1MB • Images: 8MB • Fonts: 512K
Application Memory	15µ sec per 1K of typical application
Scan Time	8192 coils, 4096 registers, 512 long integers (32-bit), 256 double words (32-bit unsigned), 64 floats, 384 timers (32-bit), 32 counters
Memory Operands	Additional non-retainable operands: 1024 X-bits, 512 X-integers, 256 X-long integers, 64 X-double words
Data Tables	120K dynamic RAM data (recipe parameters, datalogs, etc.), up to 256K fixed data
SD Card (Micro)	Store datalogs, Alarm History, Data Tables, Trend data, export to Excel • Back up Ladder, HMI & OS, clone PLCs
Enhanced Features	Trends: graph any value and display on HMI • String Library: instantly switch HMI language
Operator Panel	
Type	TFT LCD • 65,536 colors, 16-bit resolution • Brightness - Adjustable via touchscreen or software
Display	Resolution: 320 x 240 pixels (QVGA) • Size: 3.5"
Touchscreen	Resistive, Analog
Keys	5 programmable keys. Labeling options - function keys, arrows, or customized
General	
Power Supply	24VDC, except for V350-35-B1, which is 12/24VDC
Battery	7 years typical at 25°C, battery back-up for all memory sections and RTC
Clock	Real-time clock functions (date and time)
Environment	IP66/IP65/NEMA4X (when panel mounted)
Standard	CE, UL Many of our products are also UL Class 1 Div 2 and GOST certified - please contact Unitronics

¹ In some models certain inputs are adaptable via wiring and software settings, and can function as digital, high-speed, analog, and in certain models as TC or PT100. Adapting requires input pins. This reduces the number of digital inputs. Pin requirements:

- Each high-speed requires 1 or 2 pins according to high-speed mode.
- Each analog input requires 1 pin.
- Each TC requires 2 pins per TC input
- The first PT input requires 3 pins, and two additional pins for each additional PT input.

Example: V350-35-RA22 offers 12 digital inputs. Implementing 2 TC inputs requires 4 pins, leaving 8 pins free. Implementing 2 PT inputs uses 5 input pins.

² The total number of digital inputs listed includes high-speed and adaptable inputs.

³ The total number of digital outputs listed includes high-speed outputs.

VISION 130™

Palm-size, powerful PLC with built-in, black & white LCD 2.4" graphic display, keypad, & onboard I/O configuration, expand up to 256 I/Os

Features:

HMI

- 1024 user-designed screens
- 400 images per application
- HMI graphs - color-code Trends
- Built-in alarm screens
- Text String Library - easy localization
- Memory and communication monitoring via HMI - No PC needed

PLC

- I/O options include high-speed, temperature & weight measurement
- Auto-tune PID, up to 24 independent loops
- Recipe programs and datalogging via Data Tables
- Micro SD card - log, backup, clone & more
- Date & Time-based control

Communication

- TCP/IP via Ethernet
- Web server: Use built-in HTML pages, or design complex pages to view and edit PLC data via the Internet
- Send e-mail function
- SMS messaging
- GPRS/GSM
- Remote Access utilities
- MODBUS protocol support
- BACnet, KNX, M-bus – via 3rd-party converter
- CANbus: CANopen, UniCAN, SAE J1939 and more
- DF1 Slave
- SNMP Agent V1
- FB Protocol Utility: enables serial or TCP/IP communications with 3rd-party device; barcode readers, frequency converters, etc.
- Ports: supplied with 1 RS232/RS485; 2 ports may be added: 1 Serial/Ethernet/Profibus and 1 CANbus



V130-J
Flat Panel



V130
Classic Panel

“The perfect solution for our need, the Vision130™ is easy to program, user-friendly and backed up with responsive tech support.”

Michael Lamore,
President of Barrier1

Vision130™ models - Onboard I/Os

Article		Summary	Inputs ¹				Outputs				Operating voltage
			Digital ²	HSC/Shaft-encoder ²	Analog	Temperature Measurement	Transistor ³	PWM/HSO ³	Relay	Analog	
V130-J-B1	V130-33-B1	No onboard I/Os	None	None	None	None	None	None	None	None	12/24VDC
V130-J-TR20	V130-33-TR20	10 Digital, 2 D/A Inputs ¹ 6 Relay Outputs 2 High-speed Transistor Outputs	12	3 200kHz, 32-bit	2 0-10V, 0-20mA, 4-20mA 10-bit	None	2 npn	2 (2 PTO) 200 kHz max	6	None	24VDC
V130-J-R34	V130-33-R34	20 Digital, 2 D/A Inputs ¹ 12 Relay Outputs	22	3 30kHz, 32-bit	2 0-10V, 0-20mA, 4-20mA 10-bit	None	None	None	12	None	24VDC
V130-J-TR34	V130-33-TR34	20 Digital, 2 D/A Inputs ¹ 8 Relay, 4 High-speed Transistor Outputs	22	3 200kHz, 32-bit	2 0-10V, 0-20mA, 4-20mA 10-bit	None	4 npn	4 (3 PTO) 200 kHz max	8	None	24VDC
V130-J-TR6	V130-33-TR34	6 Digital, 2 D/A ¹ , 4 Analog Inputs 6 Relay Outputs 2 High-speed Transistor Outputs	8	1 200kHz, 32-bit	2 0-10V, 0-20mA, 4-20mA and 4 0-20mA, 4-20mA 10-bit	None	2 npn	2 (2 PTO) 200 kHz max	6	None	24VDC
V130-J-RA22	V130-33-RA22	8 Digital, 2 D/A, 2 TC/PT100/ Digital ¹ Inputs 8 Relay, 2 Analog Outputs	12	1 30kHz, 32-bit	2 0-10V, 0-20mA, 4-20mA 14-bit	2 Thermocouple, PT100	None	None	8	2 0-10V, 4 -20mA 12-bit	24VDC
V130-J-TRA22	V130-33-TRA22	8 Digital, 2 D/A, 2 PT100/ TC/ Digital ¹ Inputs 4 Relay, 2 Analog, 4 High-Speed Transistor Outputs	12	1 200kHz, 32-bit	2 0-10V, 0-20mA, 4-20mA 14-bit	2 Thermocouple, PT100	4 npn	4 (2 PTO) 200 kHz max	4	2 0-10V, 4 -20mA 12-bit	24VDC
V130-J-T2	V130-33-T2	10 Digital, 2 D/A Inputs ¹ 12 Transistor Outputs	12	3 30kHz, 32-bit	2 0-10V, 0-20mA, 4-20mA 10-bit	None	12 pnp	7 0.5kHz	None	None	24VDC
V130-J-T38	V130-33-T38	20 Digital, 2 D/A Inputs ¹ , 16 Transistor Outputs	22	2 30kHz, 32-bit	2 0-10V, 0-20mA, 4-20mA 10-bit	None	16 pnp	7 0.5kHz	None	None	24VDC
V130-J-TA24	V130-33-TA24	8 Digital, 2 D/A, 2 TC/PT100/ Digital ¹ Inputs 10 Transistor, 2 Analog Outputs	12	1 30kHz, 32-bit	2 0-10V, 0-20mA, 4-20mA 14-bit	2 Thermocouple, PT100	10 pnp	5 0.5kHz	None	2 0-10V, 4 -20mA 12-bit	24VDC

Product Details

I/O Expansion	Local or Remote I/Os may be added via expansion port or via CANbus. Expand up to 256 I/Os (See I/O Expansion Modules- page 28)
Program	
Application Memory	Application Logic: 512K • Images: 256K • Fonts: 128K
Scan Time	20µ sec per 1K of typical application
Memory Operands	4096 coils, 2048 registers, 256 long integers (32-bit), 64 double words (32-bit unsigned), 24 floats, 192 timers (32-bit), 24 counters Additional non-retainable operands: 1024 X-bits, 512 X-integers, 256 X-long integers, 64 X-double words
Data Tables	120K dynamic RAM data (recipe parameters, datalogs, etc.), up to 256K fixed data
SD Card (Micro)	Store datalogs, Alarm History, Data Tables, Trend data, export to Excel • Back up Ladder, HMI & OS, clone PLCs
Enhanced Features	Trends: graph any value and display on HMI • Built-in Alarm management system • String Library: instantly switch HMI language
Operator Panel	
Type	Graphic STN LCD, white LED backlight
Display	Resolution: 128 x 64 pixels • Size: 2.4"
Keys	20, including 10 user labeled keys (slide kit sold separately)
General	
Power Supply	24VDC, except for V130-33-B1, which is 12/24VDC
Battery	7 years typical at 25°C, battery back-up for all memory sections and RTC
Clock	Real-time clock functions (date and time)
Environment	IP66/IP65/NEMA4X (when panel mounted)
Standard	CE, UL
	Many of our products are also UL Class 1 Div 2 and GOST certified - please contact Unitronics

¹ In some models certain inputs are adaptable via wiring and software settings, and can function as digital, high-speed, analog, and in certain models as TC or PT100. Adapting requires input pins. This reduces the number of digital inputs. Pin requirements:

- Each high-speed requires 1 or 2 pins according to high-speed mode.
- Each analog input requires 1 pin.
- Each TC requires 2 pins per TC input
- The first PT input requires 3 pins, and two additional pins for each additional PT input.

Example: V130-33-RA22 offers 12 digital inputs. Implementing 2 TC inputs requires 4 pins, leaving 8 pins free. Implementing 2 PT inputs uses 5 input pins.

² The total number of digital inputs listed includes high-speed and adaptable inputs.

³ The total number of digital outputs listed includes high-speed outputs.

VISION 120™

Full-function PLC with built-in, monochrome graphic LCD display, keypad, & onboard I/O configuration; expand up to 256 I/Os



V120

HMI

- Up to 255 user-designed screens
- Hundreds of images per application
- HMI graphs & Trends
- Memory and communication monitoring via HMI - No PC needed

PLC

- I/O options include high-speed, temperature & weight measurement
- Auto-tune PID, up to 12 independent loops
- Recipe programs and datalogging via Data Tables
- Date & Time-based control
- 2 RS232/RS485 built-in ports

Communication

- SMS messaging
- GPRS/GSM
- Remote Access utilities
- MODBUS protocol support
- BACnet, KNX, M-bus – via 3rd-party converter
- CANbus: CANopen, UniCAN (in C models only)
- FB Protocol Utility: enables serial with 3rd-party device; barcode readers, frequency converters, etc.

I/O Expansion Modules

Article	Summary	Inputs ¹				Outputs				Operating voltage
		Digital ²	HSC/Shaft-encoder ²	Analog	Temperature Measurement	Transistor ³	PWM/HSO ³	Relay	Analog	
V120-22-R1	10 Digital, 1 Analog Inputs 6 Relay Outputs	10	3 10kHz, 32-bit	1 0-10V, 0-20mA, 4-20mA 10-bit	None	None	None	6	None	12/24VDC
V120-22-R2C	10 Digital, 2 Analog Inputs 6 Relay Outputs	10	3 10kHz, 32-bit	2 0-10V, 0-20mA, 4-20mA 10-bit	None	None	None	6	None	12/24VDC
V120-22-R6C	6 Digital, 6 Analog Inputs 6 Relay Outputs	6	1 10kHz, 32-bit	2 0-10V, 0-20mA, 4-20mA and 4 0-20mA, 4-20mA 10-bit	None	None	None	6	None	24VDC
V120-22-R34	20 Digital, 2 D/A ¹ Inputs 12 Relay Outputs	22	3 10kHz, 32-bit	2 0-10V, 0-20mA, 4-20mA 10-bit	None	None	None	12	None	24VDC
V120-22-T1	12 Digital Inputs 12 Transistor Outputs	12	2 10kHz, 32-bit	None	None	12 pnp	2 0.5kHz	None	None	12/24VDC
V120-22-T38	22 Digital Inputs 16 Transistor Outputs	22	2 10kHz, 32-bit	None	None	16 pnp		None	None	24VDC
V120-22-T2C	10 Digital, 2 D/A ¹ Inputs 12 Transistor Outputs	12	3 10kHz, 32-bit	2 0-10V, 0-20mA, 4-20mA 10-bit	None	12 pnp		None	None	12/24VDC
V120-22-UN2	10 Digital, 2 D/A/ TC/PT100 ¹ Inputs 12 Transistor Outputs	12	2 10kHz, 32-bit	2 Thermocouple, PT100, 0-10V, 0-20mA, 4-20mA 14-bit	None	12 pnp		None	None	12/24VDC
V120-22-UA2	10 Digital, 2 D/A/TC1 Inputs 10 Transistor, 2 Analog Outputs	12	1 10kHz, 32-bit	2 Thermocouple, 0-10V, 0-20mA, 4-20mA 14-bit	None	10 pnp	None	2 0-10V, 4-20mA 12-bit	24VDC	
V120-22-RA22	8 Digital, 2 D/A, 2 TC/ PT100/Digital ¹ Inputs 8 Relay, 2 Analog Outputs	12	1 10kHz, 32-bit	2 0-10V, 0-20mA, 4-20mA 14-bit	2 Thermocouple, PT100	None	None	8	2 0-10V, 4-20mA 12-bit	24VDC

Product Details

I/O Expansion	Local or Remote I/Os may be added via expansion port or via CANbus. Expand up to 256 I/Os (See I/O Expansion Modules - page 28)
Program	
Application Memory	448K (virtual) Ladder code capacity
Memory Scan Time	48µ sec per 1K of typical application
Operands	4096 coils, 2048 registers, 256 long integers (32-bit), 64 double words (32-bit unsigned), 24 floats, 192 timers (32-bit), 24 counters
Data Tables	120K dynamic RAM data (recipe parameters, datalogs, etc.), up to 256K fixed data
Operator Panel	
Type	Graphic STN LCD
Display	Resolution: 128 x 64 pixels • Size: 2.4"
Keys	16 keys
General	
Power Supply	V120-22-R1 / R2C / T1 / T2C / UN2 : 12/24VDC • V120-22-R6C / R34 / T38 / UA2 / RA22 : 24VDC
Battery	7 years typical at 25°C, battery back-up for all memory sections and RTC
Clock	Real-time clock functions (date and time)
Environment	IP65/NEMA4X (when panel mounted)
Standard	CE, UL Many of our products are also UL Class 1 Div 2 and GOST certified - please contact Unitronics

¹ In some models certain inputs are adaptable via wiring and software settings, and can function as digital, analog, and in certain models as TC or PT100. Adapting requires input pins. This reduces the number of digital inputs. Pin requirements:

- Each high-speed requires 1 or 2 pins according to high-speed mode.
- Each analog input requires 1 pin.
- Each TC requires 2 pins per TC input
- The first PT input requires 3 pins, and two additional pins for each additional PT input.

Example: V120-22-UA2 offers 12 digital inputs. Implementing 2 TC inputs requires 4 pins, leaving 8 pins free. Implementing 2 PT inputs uses 5 input pins.

² The total number of digital inputs listed includes high-speed and adaptable inputs.

³ The total number of digital outputs listed includes high-speed outputs

VISION200™

Advanced PLCs with an integrated operator panel graphic or touch. Snap-in I/Os to create an All-in-One; expand up to 316 I/Os

HMI





- Up to 255 user-designed screens
- Hundreds of images per application
- HMI graphs & Trends
- Virtual alpha-numeric keypad (in V290 & V530)
- Memory and communication monitoring via HMI - No PC needed

PLC

- I/O options include high-speed, temperature & weight measurement
- Auto-tune PID, up to 12 independent loops
- Recipe programs and datalogging via Data Tables
- Date & Time-based control

Communication

- SMS messaging
- GPRS/GSM
- Remote Access utilities
- MODBUS protocol support
- BACnet, KNX, M-bus – via 3rd-party converter
- CANbus: CANopen, UniCAN (in C models only)
- FB Protocol Utility: enables serial or TCP/IP communications with 3rd-party device; barcode readers, frequency converters, etc.
- Ports: supplied with 1 RS232, 1 RS232/RS485 and 1 CANbus; 1 port may be added for serial/Ethernet
- V280-B25B & V290-B25B Not yet UL certified

	V230™	V280™	V290™	V530™
				
Article Number	V230-13-B20B	V280-18-B20B	V290-19-B20B	V530-53-B20B
I/O Options				
Snap-in I/O Modules	Plug these modules directly into the back of the Vision unit to create a self-contained PLC with up to 62 I/Os. Inputs may include Digital, Analog and Temperature Measurement. Outputs may include Transistor, Relay or Analog (sold separately)			
I/O Expansion	Local or remote I/Os may be added via expansion port or via CANbus. Expand up to 316 I/Os (See I/O Expansion Modules - page 28)			
Program				
Application Memory	1MB			
Scan Time	30µsec per 1K of typical application			
Operands	4096 coils, 2048 registers, 256 long integers (32 bit), 64 double words (32 bit unsigned), 24 memory floats, 192 timers, 24 counters			
Data Tables	120K dynamic RAM data (recipe parameters, datalogs, etc.), up to 192K fixed data			
Operator Panel				
Type	STN LCD	Black & White FSTN LCD		
Display Resolution & Size	128 x 64 pixels 3.2"	320 x 240 pixels (QVGA), 4.7" active area	320 x 240 pixels (QVGA), 5.7" active area	
Touch Screen	None	Resistive, Analog		
Keys	24 user labeled keys	27 user labeled keys	Virtual keyboard	
General				
Power Supply	12/24VDC			
Battery Back-up	7 years typical at 25°C, back-up for all memory sections and real-time clock (RTC)			
Environment	IP65/NEMA4X (when panel mounted)			
Standard	CE, UL Many of our products are also UL Class 1 Div 2 and GOST certified - please contact Unitronics			

Full-function PLC with built-in high resolution full-color touch-screen, & onboard I/O configuration. Great look, incredible price.

Features:

HMI

- Display: Color touch-screen
3.5" - 320 x 240, 4.3" - 480 x 272, 7" - 800 x 480
- 24 user-designed screens and 500 images per application
- HMI graphs - color-code Trends
- Built-in alarm screens
- Text String Library - easy localization
- Memory and communication monitoring via HMI - No PC needed

PLC

- I/O options: Digital, Analog, including High-speed
- Auto-tune PID, 2 independent loops
- Recipe programs and data logging via Data Tables
- Date & Time-based control

Communication

- TCP/IP via Ethernet
- Send e-mail function
- SMS messaging
- GPRS/GSM
- Remote Access utilities
- MODBUS protocol supported
- BACnet, KNX, M-bus – via 3rd-party converter
- CANbus: CANopen, UniCAN, SAE J1939, and more
- DF1 Slave
- Programming Port: RS232 for 3.5" model, USB for 4.3" & 7"
- 2 ports may be added: 1 Serial (RS232/RS485)/ Ethernet & 1 CANbus



SAMBA 3.5"



SAMBA 4.3"



SAMBA 7"



“ It really enhanced our product’s look and flexibility. ”



Ralph Hannmann,
President of Alyan Pump Company

Samba™ models - Onboard I/Os

Article	summary	Inputs ¹				Outputs				Operating voltage
		Digital ²	HSC/Shaft-encoder ²	Analog	Temperature Measurement	Transistor ³	PWM/HSO ³	Relay	Analog	
SM35-J-R20 SM43-J-R20 SM70-J-R20	10 Digital, 2 D/A Inputs ⁴ , 8 Relay Outputs	12	1 30kHz, 32-bit	2 0-10V, 0-20mA, 4-20mA 10-bit	None	None	None	8	None	24VDC
SM35-J-T20 SM43-J-T20 SM70-J-T20	10 Digital, 2 D/A Inputs, 8 Transistor Outputs	12	3 30kHz, 32-bit	2 0-10V, 0-20mA, 4-20mA 10-bit	None	8 pnp	7 0.5kHz	None	None	24VDC
SM35-J-RA22 SM43-J-RA22 SM70-J-RA22*	12 Digital, 1 HSC/Shaft- encoder, 2 AI , 2 PT100/TC, 8 Relay, 2 AO	12	1 30kHz, 32-bit	2 0-10V, 0-20mA, 4-20mA 12/14-bit	2 PT100/TC	None	None	8	0-10V, 4-20mA, 12-bit	24VDC
SM35-J-TA22 SM43-J-TA22* SM70-J-TA22*	12 Digital, 1 HSC/Shaft- encoder, 2 AI, 2 PT100/TC, 8 Transistor, 2 AO	12	1 30kHz, 32-bit	2 0-10V, 0-20mA, 4-20mA 12/14-bit	2 PT100/TC	8 pnp	5 0.5kHz	None	0-10V, 4-20mA, 12-bit	24VDC

Product Details

I/O Expansion	Remote I/Os via CANbus
Program	
Application Memory	SM35: Application Logic: 112kb • Images: 1.5 MB • Fonts: 512 k SM43: Application Logic: 112kb • Images: 3 MB • Fonts: 512 k SM70: Application Logic: 112kb • Images: 8 MB • Fonts: 512 k
Scan Time	15µS per 1K of typical application
Memory Operands	512 coils, 256 registers, 32 long integers (32-bit), 32 double words (32-bit unsigned), 24 floats, 32 timers (32-bit), 16 counters. Additional non-retainable operands: 64 X-bits, 32 X-integers, 16 X-long integers, 16 X-double words
Data Tables	32K dynamic RAM data (recipe parameters, datalogs, etc.), up to 16K fixed data
SD Card	None
Enhanced Features	Trends: graph any value and display on HMI • String Library: instantly switch HMI language
Operator Panel	
Type & Colors	TFT LCD • 65,536 colors • 16 bit resolution • Brightness - Adjustable via touchscreen or software
Display	Resolution: 320 x 240 pixels • Size: 3.5" (QVGA) Resolution: 480 x 272 pixels • Size: 4.3" Resolution: 800 x 480 pixels • Size: 7"
Touchscreen	Resistive, Analog
Keys	Displays virtual keyboard when the application requires data entry
General	
Power Supply	24VDC
Battery	7 years typical at 25°C, battery back-up for RTC and system data, including variable data
Clock	Real-time clock functions (date and time)
Environment	NEMA4X/IP66/IP65 (when panel mounted)
Standard	CE, UL Many of our products are also UL Class 1 Div 2 and GOST certified - please contact Unitronics

¹ In some models certain inputs are adaptable via wiring and software settings, and can function as digital or analog.

Adapting requires input pins. This reduces the number of digital inputs.

Pin requirements:

• Each analog input requires 1 pin.

Example: SM35-J-R20 offers 12 digital inputs. Implementing 2 analog inputs requires 2 pins, leaving 10 pins free.

² The total number of digital inputs listed includes high-speed and adaptable inputs.

³ The total number of digital outputs listed includes high-speed outputs.

⁴ When selecting NPN for the digital inputs, the 2 Analog inputs cannot be used.

*Not yet UL certified

An All-in-One that is as affordable as a „smart relay” - full-function PLC combined with a textual HMI and keyboard, with up to 40 onboard I/Os.

Meet the New Jazz 2 series Advantages:

- Faster performance - 30x faster
- Double the memory
- Built-in mini-USB programming port
- Ethernet via Add-on Port
- Fully compatible with current Jazz projects

Features:

HMI

- Up to 60 user-designed screens
- Multilingual: supports over 15 languages and 20 graphic symbols

PLC

- Ladder Logic programming ensures functional flexibility
- Functions include: interrupt, loops, math, store & compare functions
- Date & Time-based control
- High-speed counters & PWM outputs
- Direct temperature inputs
- Auto-tune PID, up to 4 loops

Communication

- SMS messaging via GSM
- Remote Access utilities
- PC access via MODBUS or OPC server
- Supports MODBUS protocol



Jazz®-J
Flat Panel



Jazz®
Classic Panel

“The Unitronics PLC provided the perfect solution for our need for control. Whether it was safety, mechanical or functionality, the Jazz had it all.”

Peter Spano,
President of GTS

Article	Summary	Inputs ¹				Outputs				Operating voltage	
		Digital ²	HSC/Shaft-encoder ²	Analog	Temperature Measurement	Transistor ³	PWM/HZO ³	Relay	Analog		
JZ20-J-R10	6 Digital Inputs 4 Relay Outputs	6	2 10kHz, 16-bit	None	None	None	None	4	None	24VDC	
JZ20-J-R16	6 Digital, 2 D/A, 2 Analog Inputs ¹ 6 Relay Outputs	8		2 0-10V 10 or 12-bit 2 0-20mA, 4-20mA 10-bit	None	None	None	6	None	24VDC	
JZ20-J-R16HS	6 Digital, 3 HSC/Shaft-encoder, 2 A/D, 2 AI, 6 Relay outputs	8		2 0-10V 10 or 12-bit 2 0-20mA, 4-20mA 10-bit	None	None	None	6	None	24VDC	
JZ20-J-R31	16 Digital, 2 D/A, 2 Analog Inputs ¹ 11 Relay Outputs	18		2 0-10V 10 or 12-bit 2 0-20mA, 4-20mA 10-bit	None	None	None	11	None	24VDC	
JZ20-J-T10	6 Digital Inputs 4 Transistor Outputs	6		None	None	4 pnp	None	None	None	24VDC	
JZ20-J-T18	6 Digital, 2 D/A, 2 Analog Inputs ¹ 8 Transistor Outputs	8		2 0-10V 10-bit 2 0-20mA, 4-20mA 10-bit	None	8 pnp	None	None	None	24VDC	
JZ20-J-T20HS	6 Digital, 3 HSC/Shaft-encoder, 2 A/D, 2 AI, 10 Transistor outputs	8		2 0-10V 10-bit 2 0-20mA, 4-20mA 10-bit	None	8 pnp	2 32kHz	None	None	24VDC	
JZ20-J-T40	16 Digital, 2 D/A, 2 Analog Inputs ¹ 20 Transistor Outputs	18		2 0-10V 10-bit 2 0-20mA, 4-20mA 10-bit	None	20 pnp	None	None	None	24VDC	
JZ10-J-UN20	9 Digital, 2 D/A, 1 Analog 1 TC/PT100 Inputs ¹ 5 Relay 2 Transistor Outputs	11		1 5kHz, 16-bit	2 0-10V 10-bit 1 0-20mA, 4-20mA 10-bit	1 Thermocouple, PT100	2 pnp	2	5	None	24VDC
JZ10-J-UA24	9 Digital, 2 D/A, 2 Analog 2 TC/PT100 Inputs ¹ 5 Relay 2 Analog 2 Transistor Outputs	11			2 0-10V 10-bit 2 0-20mA, 4-20mA 10-bit	2 Thermocouple, PT100	2 pnp	2	5	2 +/-10V, 4 -20mA 12-bit	24VDC
JZ10-J-PT15	3 Digital, 3 D/A, 3 PT1000/NI1000 Inputs ¹ 3 Relay 1 Transistor Outputs	6	3 0-10V ² 10-bit		3 PT1000/NI1000	1 pnp	1	5	None	24VDC	

Jazz 2 - Soon to come

Product Details

Program	
Ladder Code Memory	JZ20: 48K • JZ10: 24K
Memory Operands	256 coils, 256 registers, 64 timers
Operator Panel	
Type	STN LCD
Display	2 lines x 16 characters
Touchscreen	16 keys, 10 of which may be user-labeled
General	
Power Supply	24VDC
Battery	10 years typical at 25°C, battery back-up for RTC and system data, including variable data
Clock	Real-time clock functions (date and time)
Environment	NEMA4X/IP65 (when panel mounted)
Standard	CE, UL Many of our products are also UL Class 1 Div 2 and GOST certified - please contact Unitronics
Programming Port	JZ20: On Board Mini USB • JZ10: Article No.: JZ-PRG sold separately
Communication	
Serial	RS232/RS485 Add-on port (isolated) Article No.: JZ-RS4 sold separately
Ethernet	JZ20: Ethernet add-on port Article No.: MJ20-ET1 sold separately • JZ10: Not supported

¹ In some models certain inputs are adaptable, and can function as either digital or analog. Adapting requires input pins. This reduces the number of digital inputs. Pin requirements: • Each analog input requires 1 pin.

² Note that the high-speed inputs are included in the total number of digital inputs

³ Note that the high-speed outputs are included in the total number of npn/pnp digital outputs

⁴ In order to download applications and enable communications, install Jazz® with the appropriate Add-on Module. JZ20 can be programmed via built-in USB device port.

Add-on modules and accessories²

New!

COM Port kit	Ethernet Communication Port	Program Cloner module	Keypad Slide kit
RS232/RS485 Add-on port (isolated) Article No.: JZ-RS4	Ethernet add on port Supported by Jazz® 2 series only Article No.: MJ20-ET1 *	Copy applications from PLC to PLC Article No.: MJ20-MEM1	Customize the Jazz® keypad to your application Article No.: MJ20-JZ-SL1

* Not yet UL certified

M91™

An affordable All-in-One: a smart PLC with a textual HMI and keyboard, plus an onboard I/O configuration; expand up to 150 I/Os.

Features:

HMI

- Up to 80 user-designed screens
- Multilingual: supports over 15 languages and 20 graphic symbols
- Scroll between pre-programmed recipes/menus
- Memory and communication monitoring via HMI - No PC needed

PLC

- Shaft-encoder inputs and PWM outputs
- Direct temperature inputs
- Auto-tune PID, up to 4 loops
- Date & Time-based control
- Database
- Print utilities
- Full source upload

Communication

- SMS messaging via GSM
- Remote access utilities
- PC access via MODBUS or OPC server
- Supports MODBUS protocol
- CANBus (in C models only)
- User-defined ASCII strings, enable communication with external devices
- RS232/RS485 built-in port



M91



M91™ models - Onboard I/Os

Article	summary	Inputs ¹				Outputs				Operating voltage
		Digital ²	HSC/Shaft-encoder ²	Analog	Temperature Measurement	Transistor ³	PWM/HSO ³	Relay	Analog	
M91-2-R1	10 Digital, 1 Analog Inputs 6 Relay Outputs	10	3 10kHz, 32-bit	1 0-10V, 0-20mA, 4-20mA 10-bit	None	None	None	6	None	12/24VDC
M91-2-R2C	10 Digital, 2 Analog Inputs 6 Relay Outputs	10	3 10kHz, 32-bit	2 0-10V, 0-20mA, 4-20mA 10-bit	None	None	None	6	None	12/24VDC
M91-2-R6C	6 Digital, 6 Analog Inputs 6 Relay Outputs	6	1 10kHz, 32-bit	2 0-10V, 0-20mA, 4-20mA 4 0-20mA, 4-20mA 10-bit	None	None	None	6	None	24VDC
M91-2-R34	20 Digital, 2 D/A ¹ Inputs 12 Relay Outputs	22	3 10kHz, 32-bit	2 0-10V, 0-20mA, 4-20mA 10-bit	None	None	None	12	None	24VDC
M91-2-T1	12 Digital Inputs 12 Transistor Outputs	12	2 10kHz, 32-bit	None	None	12 pnp	2 0.5kHz	None	None	12/24VDC
M91-2-T38	22 Digital Inputs 16 Transistor Outputs	22	2 10kHz, 32-bit	None	None	16 pnp		None	None	24VDC
M91-2-T2C	10 Digital, 2 D/A ¹ Inputs 12 Transistor Outputs	12	3 10kHz, 32-bit	2 0-10V, 0-20mA, 4-20mA 10-bit	None	12 pnp		None	None	12/24VDC
M91-2-UN2	10 Digital, 2 D/A/ PT100/TC ¹ Inputs 12 Transistor Outputs	12	2 10kHz, 32-bit	2 Thermocouple, PT100, 0-10V, 0-20mA, 4-20mA 14-bit	None	12 pnp		None	None	12/24VDC
M91-2-UA2	10 Digital, 2 D/A/TC ¹ Inputs 10 Transistor, 2 Analog Outputs	12	1 10kHz, 32-bit	2 Thermocouple, 0-10V, 0-20mA, 4-20mA 14-bit	None	10 pnp		None	2 0-10V, 4-20mA 12-bit	24VDC
M91-2-RA22	8 Digital, 2 D/A, 2 PT100/ TC/Digital ¹ Inputs 8 Relay, 2 Analog Outputs	12	1 10kHz, 32-bit	2 0-10V, 0-20mA, 4-20mA 14-bit	2 Thermocouple, PT100	None	None	8	2 0-10V, 4-20mA 12-bit	24VDC

Product Details

I/O Expansion	I/Os may be added via expansion port. Expand up to 150 I/Os
Program	
Application Memory	36K (virtual) Ladder code capacity
Memory Operands	256 coils, 256 registers, 64 timers
Database	1024 integers, (indirect access)
Operator Panel	
Type	STN LCD
Display Size	2 lines x 16 characters
Keys	15 keys
General	
Power Supply	M91-2-R1 / R2C / T1 / T2C / UN2 : 12/24VDC • M91-2-R6C / R34 / T38 / UA2 / RA22 : 24VDC
Battery	7 years typical at 25°C, battery back-up for all memory sections and RTC
Clock (RTC)	Real-time clock functions (date and time)
Environment	IP65/NEMA4X (when panel mounted)
Standard	CE, UL Many of our products are also UL Class 1 Div 2 and GOST certified - please contact Unitronics

¹ In some models certain inputs are adaptable via wiring and software settings, and can function as digital, high-speed, analog and in certain models as TC or PT100. Adapting requires input pins. This reduces the number of digital inputs. Pin requirements:

- Each high-speed requires 1 or 2 pins according to high-speed mode.
- Each analog input requires 1 pin.
- Each TC requires 2 pins per TC input
- The first PT input requires 3 pins, and two additional pins for each additional PT input.

Example: V91-2-UA2 offers 12 digital inputs. Implementing 2 TC inputs requires 4 pins, leaving 8 pins free. Implementing 2 PT inputs uses 5 input pins.

² The total number of digital inputs listed includes high-speed and adaptable inputs.

³ The total number of digital outputs listed includes high-speed outputs.

I/O Expansion Modules

Expand your system with local or remote I/O expansion modules.

Vision series support both local & remote I/O modules. M91 supports local modules only.

	Expansion Modules article	Inputs					Outputs				Operating voltage	
		Digital ¹	HSC/Shaft-encoder ⁵	Analog	Temperature Measurement	Weight Measurement	Transistor ⁶	PWM/HSO ⁶	Relay	Analog		
Digital	IO-DI8-T08	8 pnp/npn	1 5kHz 16-bit	None	None	None	8 pnp	None	None	None	None	24VDC ⁹
	IO-DI8-R04	8 pnp/npn	1 5kHz 16-bit	None	None	None	None	None	4	None	None	24VDC ⁹
	IO-DI8-R08	8 pnp/npn	1 5kHz 16-bit	None	None	None	None	None	8	None	None	24VDC ⁹
	EX90-DI8-R08 ³	8 pnp	1 5kHz 16-bit	None	None	None	None	None	8	None	None	24VDC
	IO-DI16	16 pnp/npn	1 5kHz 16-bit	None	None	None	None	None	None	None	None	24VDC ⁹
	IO-TO16	None	None	None	None	None	16 pnp	None	None	None	None	24VDC
	IO-R08	None	None	None	None	None	None	None	8	None	None	24VDC ⁹
	IO-R016	None	None	None	None	None	None	None	16	None	None	24VDC ⁹
	IO-DI8ACH	8 AC	None	None	None	None	None	None	None	None	None	110/220 VAC
Analog, Temperature and Weight/Strain Measurements	IO-AI4-A02	None	None	4 0-10V, 0-20mA, 4-20mA 12-bit	None	None	None	None	None	None	2 ±10V 12-bit+sign, 0-20mA, 4-20mA 12-bit	24VDC
	IO-PT400	None	None	None	4 PT100/NI100/NI120	None	None	None	None	None	None	Not relevant
	IO-PT4K	None	None	None	4 PT1000/NI1000	None	None	None	None	None	None	Not relevant
	IO-A06X	None	None	None	None	None	None	None	None	None	6 (Isolated) 0-10V, 0-20mA, 4-20mA 12-bit	24VDC
	IO-LC1	1 pnp	None	None	None	1 Loadcell / Strain gauge	2 pnp	None	None	None	None	24VDC
	IO-LC3	1 pnp	None	None	None	3 Loadcell / Strain gauge	2 pnp	None	None	None	None	24VDC
	IO-ATC8	None	None	8 Thermocouple, 0-10V, 0-20mA, 4-20mA 14-bit	None	None	None	None	None	None	None	Not relevant
	IO-AI8	None	None	8 0-10V, 0-20mA, 4-20mA 14-bit	None	None	None	None	None	None	None	Not relevant
XL Digital/ Analog	IO-D16A3-R016	16 pnp/npn	2 30kHz 16/32-bit ⁸	3 0-20mA, 4-20mA 10-bit	None	None	None	None	16	None	None	24VDC
	IO-D16A3-T016	16 pnp/npn	1 30kHz 16/32-bit ⁸	3 0-20mA, 4-20mA 10-bit	None	None	15 pnp, 1 pnp/npn	1 pnp 0.5kHz npr 50kHz	None	None	None	24VDC
	EX-D16A3-R08 ⁷	16 pnp/npn	2 30kHz 16/32-bit ⁸	3 0-20mA, 4-20mA 10-bit	None	None	None	None	8	None	None	24VDC
	EX-D16A3-T016 ⁷	16 pnp/npn	1 30kHz 16/32-bit ⁸	3 0-20mA, 4-20mA 10-bit	None	None	15 pnp 1 pnp/npn	1 pnp 0.5kHz npr 50kHz	None	None	None	24VDC
High-speed Remote I/O Module	EXF-RC15 ^{2,4}	9 pnp/npn	3 200kHz 32-bit	None	None	None	4 npr	4 (up to 3 PTO)	2	None	None	24VDC

I/O Expansion Module Adapters

I/O Expansion Module Adapters	Article	Description
	EX-A2X ¹	Local I/O module adapter, Galvanic isolation. Up to 8 modules may be connected to a single PLC ¹ . Supports both 12/24 VDC
EX-RC1 ^{1,4}	Remote I/O module adapter, via CANbus. Multiple adapters may be connected to a single PLC, with up to 8 modules to each adapter ¹ . Supports both 12/24 VDC.	

- Number of supported I/Os & I/O modules varies according to module.
- The EXF-RC15 functions as a node in a Vision UniCAN network and connects to the Vision controller via CANbus and programmed in VisiLogic. The EXF-RC15 cannot be extended as regular I/O unit.
- The EX90 is housed in an open casing. Only one EX90 can be connected per PLC, as a single expansion module; Expansion adapter not required.
- Supported by Vision series. Not supported by M91 series.
- The total number of digital inputs listed includes high-speed inputs. Example: the IO-D16A3-T016 offers a total of 16 pnp/npn inputs. You can configure 14 as a HSC and 15 as a Counter reset; this reduces the available number of digital inputs to 14.
- The total number of digital outputs listed includes high-speed outputs. Example: the IO-D16A3-T016 offers a total of 16 transistor outputs. You can configure 1 to high-speed output, reducing the number of available digital outputs to 15.
- Functions as local adapter. Can support up to 7 I/O modules.
- 16-bit or 32-bit, depending on the PLC.
- Also available as 12VDC – contact us for part number.

Snap-in I/O Modules

CE/UL



Plug a Snap-in module directly into the back of a Vision PLC.
Compatible with all V200, V500, V1040 and V1210 Vision series models.

Snap in IO Article	Inputs				Outputs				Operating voltage
	Digital (isolated) ¹	HSC/Shaft-encoder ¹	Analog	Temperature Measurement	Transistor (isolated) ²	PWM/HSO ²	Relay	Analog	
V200-18-E1B	16 pnp/npn	2 10kHz 32-bit	3 0-10 V, 0-20mA, 4-20mA 10-bit	None	4 pnp/npn	2 pnp 0.5kHz npn 50kHz	10	None	24VDC
V200-18-E2B	16 pnp/npn	2 10kHz 32-bit	2 0-10 V, 0-20mA, 4-20mA 10-bit	None	4 pnp/npn	2 pnp 0.5kHz npn 50kHz	10	2 0-10 V, 0-20mA, 4-20mA 12-bit	24VDC
V200-18-E3XB	18 pnp/npn	2 10kHz 32-bit	4 (Isolated) Thermocouple, PT100, 0-10V, 0-20mA, 4-20mA 14-bit		2 pnp/npn	2 pnp 0.5kHz npn 50kHz	15	4 (Isolated) 0-10 V, 4-20mA 12-bit	24VDC
V200-18-E4XB	18 pnp/npn	2 10kHz 32-bit	4 (Isolated) Thermocouple, PT100, 0-10V, 0-20mA, 4-20mA 14-bit		15 pnp 2 npn/npn	2 pnp 0.5kHz npn 50kHz	None	4 (Isolated) 0-10 V, 4-20mA 12-bit	24VDC
V200-18-E5B	18 pnp/npn	2 10kHz 32-bit	3 0-10 V, 0-20mA, 4-20mA 10-bit	None	15 pnp 2 npn/npn	2 pnp 0.5kHz npn 50kHz	None	None	24VDC
V200-18-E6B	18 pnp/npn	2 10kHz 32-bit	2 Thermocouple, PT100, 0-10V, 0-20mA, 4-20mA 14-bit 3 0-10V, 0-20mA, 4-20mA 10-bit		2 pnp/npn	2 pnp 0.5kHz npn 50kHz	15	2 (Isolated) 0-10 V, 4-20mA 12-bit	24VDC
V200-18-E46B ³	18 pnp/npn	2 10kHz 32-bit	6 0-10 V, 0-20mA, 4-20mA 14-bit 3 0-10 V, 0-20mA, 4-20mA 10-bit	None	2 pnp/npn	2 pnp 0.5kHz npn 100kHz	15	2 (Isolated) 0-10 V, 4-20mA 12-bit	24VDC
V200-18-E62B ³	30 pnp/npn	2 10kHz 32-bit	2 0-10 V, 0-20mA, 4-20mA 10-bit	None	28 pnp 2 npn/npn	2 pnp 0.5kHz npn 100kHz	None	None	24VDC

1. The total number of digital inputs listed includes high-speed inputs.
2. The total number of digital outputs listed includes high-speed outputs.
3. Not yet UL certified

Additional COM Modules

Enhance Vision's communication capabilities¹

Vision Model	Ethernet	RS232/RS485	Isolated RS232/RS485	CANbus	Profibus ²
SAMBA	V100-17-ET2	V100-17-RS4	V100-17-RS4X	V100-17-CAN	None
V130, V350, V430	V100-17-ET2, V100-S-ET2 ²	V100-17-RS4	V100-17-RS4X	V100-17-CAN, V100-S-CAN	V100-17-PB1
V200, V500, V1040, V1210 ¹	V200-19-ET2	V200-19-RS4	V200-19-RS4-X	Build in	None
V700	Included	V100-17-RS4	V100-17-RS4X	V100-17-CAN	V100-17-PB1

1. V200/V500/V1040/V1210: 1 optional port for serial or Ethernet, V130/V350: 1 optional port for serial or Ethernet & 1 optional port for CANbus/ Profibus.
2. Extended temperature cards, operational temperature: -30°C to 60°C

DIN-rail Power Supplies

UAP-24V24W	UAP-24V60W	UAP-24V96W
24W 24V 1A	60W 24V 2.5A	96W 24V 4A

GSM

GSM-KIT-17J-3G
KIT, MODEM GPRS, CINTERION, EHS6T



Configure your Network

Collect & communicate data.

Display, access, and remotely control your application.

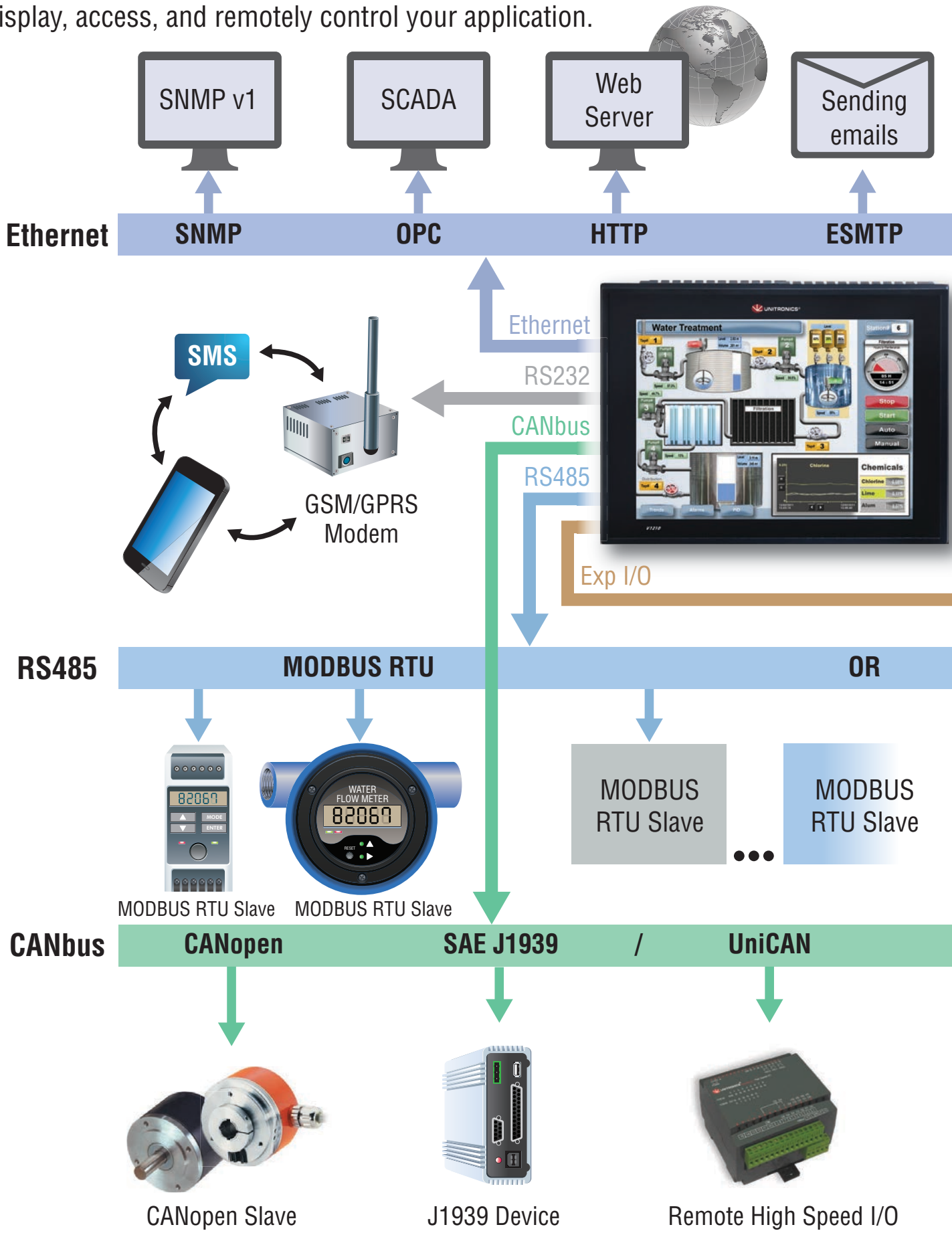

This image is for illustrative purposes only. Features and capabilities vary according to model.

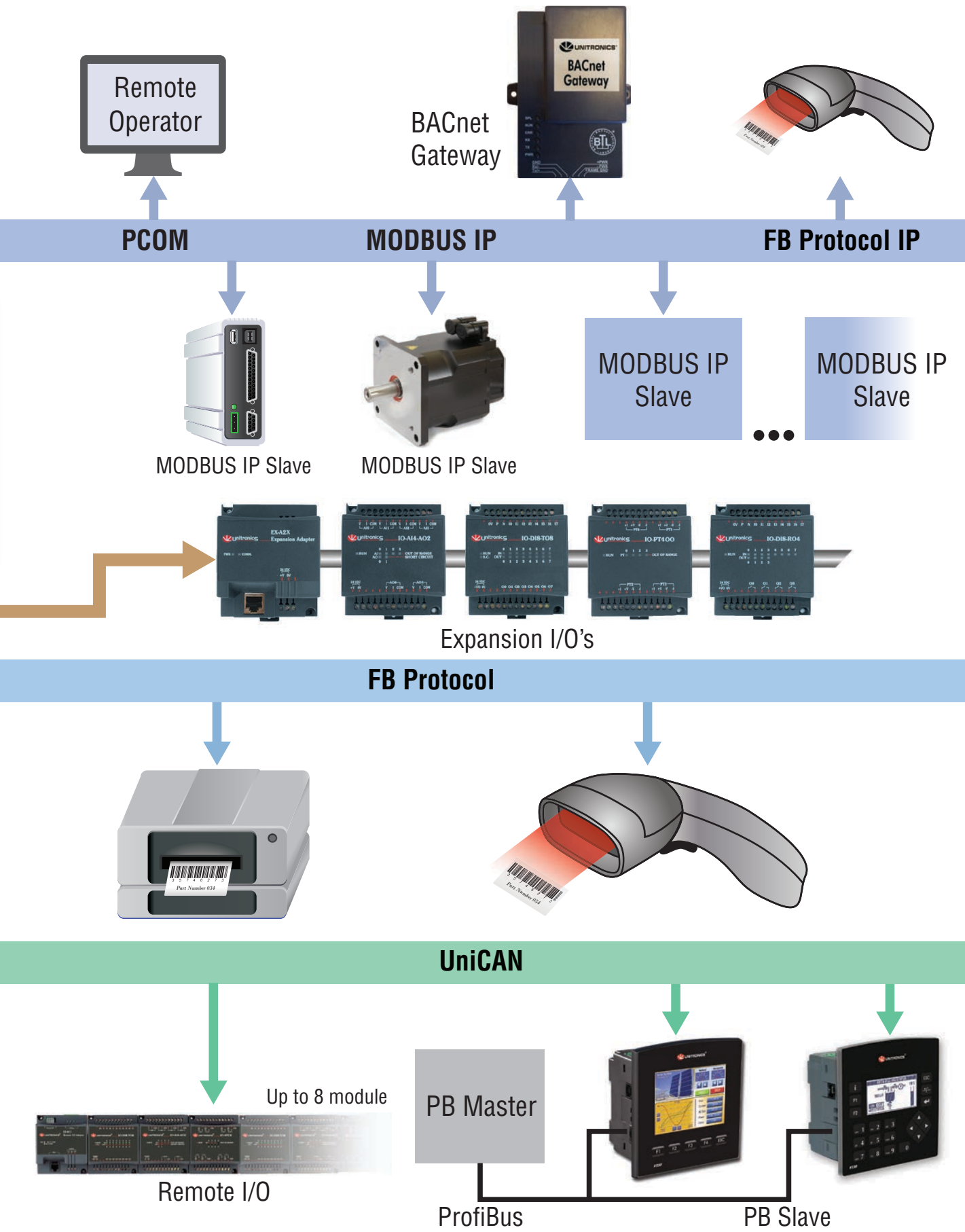

-  **Argentina:**
AEA SACIF
Tel: 11 457 41 555, Fax: 11 457 42 400
servicioalcliente@aea.com.ar, www.aea.com.ar
-  **Australia:**
Micromax Specialists in Automation
Tel: 1300 36 26 26, Fax: 1300 01 71 00
info@micromaxsa.com.au, www.micromaxsa.com.au
-  **Austria:**
Schmachtl GmbH
Tel: 0732/7646-0, Fax: 0732/7-646-704
office@schmachtl.at, www.schmachtl.at
-  **Belarus:**
Klinkmann Belarus
Tel: 17 2000876, Fax: 17 2272082
minsk@klinkmann.com, www.klinkmann.com
-  **Belgium:**
Isotron Systems BVBA
Tel: 034 507 045, Fax: 034 507 046
info@isotron.eu, www.isotron.eu
-  **Bosnia and Herzegovina:**
Tipteh d.o.o. Beograd
Tel: 381 11 30 18 326, Fax: 381 11 31 31 057
damir.vecerka@tipteh.rs, www.tipteh.rs
-  **Brazil:**
DAKOL Instrumentos e Sistemas Ltda.
Tel: (11) 3231 4544, Fax: (11) 3231 4544
vendas@dakol.com.br, www.dakol.com.br
-  **Bulgaria:**
Semo Ltd.
Tel: 2 942 4754, Fax: 2 942 4762
engineering@semo.bg, www.semo.bg
-  **Canada:**
Unitronics, Inc.
Toll free: 866 666 6033
Tel: 617 657 6596, Fax: 617 657 6598
usa.sales@unitronics.com, www.unitronics.com
-  **Chile:**
Schädler Sick SpA
Tel: (2) 274 7430, Fax: (2) 204 9338
info@schadler.com, www.schadler.com
-  **China:**
Beijing Ample Thrive CO, Ltd.
Tel: 010-88177186, 010-88177187
sales@a082.com, www.a082.com
-  **Colombia:**
COLSEIN Ltda.
Tel: 1-519 0967, Fax: 1-519 0967 Ext. 101
info@colsein.com.co, www.colsein.com.co
-  **Croatia:**
Tipteh d.o.o. (Slovenia)
Tel: 013 816 574, Fax: 013 816 577
tipteh@tipteh.hr, www.tipteh.si
-  **Cyprus:**
Anaxagoras Pneumatics Ltd.
Tel: 022 442 200, Fax: 022 495 953
sales@anaxagoras.eu, www.anaxagoras.eu
-  **Czech Republic:**
Schmachtl CZ, spol. s r.o.
Tel: 244 001 559, Fax: 244 910 700
unitronics@schmachtl.cz, www.schmachtl.cz
-  **Denmark:**
Desim Elektronik ApS
Tel: 70 22 00 66, Fax: 70 22 22 20
desim@desim.dk, www.desim.dk
-  **Ecuador:**
Local Ecuadorian distributors: contact Unitronics Ltd.
Tel (Israel): +972 3 9778893 / 5, Fax: +972 3 9778877
export@unitronics.com, www.unitronics.com
-  **Estonia:**
Klinkmann Eesti AS
Tel: 6 684 500, Fax: 6 684 501
klinkmann.est@klinkmann.ee, www.klinkmann.com
-  **Finland:**
Klinkmann Automation Oy
Tel: 9 540 49 40, Fax: 9 541 35 41
automation@klinkmann.fi, www.klinkmann.com
-  **France:**
PL Systems
Tel: 016 092 4171, Fax: 016 928 4193
info@pl-systems.fr, www.pl-systems.fr
-  **Germany:**
Spectra GmbH & Co. KG.
Tel: 0 71 21/ 143 21-0, Fax: 0 71 21/ 143 21-90
spectra@spectra.de, www.spectra.de
-  **Greece:**
Automation & Power Control Ltd.
Tel: 210 531 3111, Fax: 210 598 1435
info@apc.com.gr, www.apc.com.gr
-  **Hong Kong:**
Automate Control Engineering Ltd.
Tel: 02 342 72 76, Fax: 02 342 72 29
ace@automate.corp.com.hk, www.automate-ace.com
-  **Honduras:**
Electrical Dealer
Tel: 558 1400, Fax: 557 9709
info@electrical-dealer.com, www.electrical-dealer.com
-  **Hungary:**
Kvalix Automatika Kft.
Tel: 1 272 2242, Fax: 1 272 2244
info@kvalix.hu, www.kvalix.hu
-  **Iceland:**
Samey ehf
Tel: 510 5200, Fax: 510 5200
Sala@samey.is, www.samey.is
-  **India:**
Rajdeep Automation Pvt Ltd.
Tel: 020-243 937 55, Fax: 020 243 937 56
sales@rajdeep.in / info@rajdeep.in, www.rajdeep.in
-  **Ireland:**
UMAC Systems Ltd.
Tel (Israel): +353 1 9055835
sales@umacsystems.com, www.umacsystems.com
-  **Israel:**
Zivan Instruments Co. Ltd.
Tel: 04 872 98 22, Fax: 04 872 66 27
info@zivan.co.il, www.zivan.co.il
-  **Italy:**
TELESTAR s.r.l.
Tel: +39 0321 966 768, Fax: +39 0321 996 281
telestari@telestari-automation.it, www.telestari-automation.it
-  **Kazakhstan:**
LLP Klinkmann Kazakhstan
Tel: +7 (777) 999 48 25, Fax: +7 (777) 152 51 54
sales@klinkmann.kz
-  **Latvia:**
Klinkmann Lat Ltd.
Tel: 6738 16 17, Fax: 6738 24 51
klinkmann@klinkmann.lv, www.klinkman.com
-  **Lithuania:**
UAB Klinkmann Lit
Tel: 5 216 1646, Fax: 5 216 2641
post@klinkmann.lt, www.klinkmann.com
-  **Macedonia:**
Tipteh d.o.o. Skopje
Tel: 070 399 474, Fax: 023 174 197
tipteh@on.net.mk, www.tipteh.si
-  **Malaysia:**
Yewtech SDN BHD
Tel: 168 761 575, Fax: 856 112 99
sales@yewtech.com, www.yewtech.com
-  **Malta:**
RAYAIR Automation Limited
Tel: 2 16 724 97, Fax: 21 8 051 81
Info@rayair-automation.com
sales@rayair-automation.com, www.rayair-automation.com
-  **Mexico:**
Sistemas de Control Autec, S.A. de C.V.
Tel: 55 527 885 19, Fax: 55 527 885 32
soporte@scautec.com, www.scautec.com
-  **The Netherlands:**
Isotron Systems BV
Tel: 073 639 1639, Fax: 073 639 1699
info@isotron.nl, www.isotron.nl
-  **New Zealand:**
EMC Industrial Group Ltd.
Tel: 9 415 5110, Fax: 9 415 51 15
sales@emc.co.nz, www.emc.co.nz
-  **Nigeria:**
Technosuite Limited
Tel: 1 804 0237, Fax: 1 271 6985
enquiries@technosuiteitd.com, www.technosuiteitd.com
-  **Norway:**
Tormatic as
Tel: 33 16 50 20, Fax: 33 16 50 45
info@tormatic.no, www.tormatic.no
-  **Peru:**
EPLI SAC
Tel: 330 1595, Fax: 431 1492
info@epli.com.pe, www.epli.com.pe
-  **Philippines:**
Cosine Industries INC
Tel: 2 350 74 48, Fax: 2 412 73 21
sales@cosine.net.ph, www.cosine.net.ph
-  **Poland:**
Elmark Automatyka Sp. zo.o.
Tel: 22 541 84 60, Fax: 22 541 84 61
elmark@elmark.com.pl, www.elmark.com.pl
-  **Portugal:**
Tecnilab Portugal, SA
Tel: 21 722 08 70, Fax: 21 726 45 50
geral@tecnilab.pt, www.tecnilab.pt
-  **Romania:**
Local Romanian distributors: contact Unitronics Ltd.
Tel (Israel): +972 3 9778893 / 5, Fax: +972 3 9778877
export@unitronics.com, www.unitronics.com
-  **Russia:**
ZAO Klinkmann Spb
St.Petersburg
Tel: 812 327 37 52/26, Fax: 812 327 37 53
klinkmann@Klinkmann.spb.ru, www.klinkmann.com
Moscow branch
Tel: 495 641 1616, Fax: 495 641 3434
moscow@klinkmann.spb.ru, www.klinkman.com
Yekaterinburg branch
Tel: 343 287 19 19, Fax: 343 287 19 19
yekaterinburg@klinkmann.spb.ru, www.klinkman.com
Samara branch
Tel: 846 273 95 85, Fax: 846 273 95 85
samara@klinkmann.spb.ru, www.klinkman.com
-  **Serbia:**
Tipteh d.o.o. Beograd
Tel: 381 11 30 18 326, Fax: 381 11 31 31 057
damir.vecerka@tipteh.rs, www.tipteh.rs
-  **Singapore:**
YT AUTOMATION SINGAPORE PTE LTD
Tel: 66840702, Fax: 66840703
ytautomation@singnet.com.sg, www.ytautomation.com
-  **Slovakia:**
S.D.A. s.r.o.
Tel: 48 472 34 11, Fax: 48 472 34 69
sekreariat@s-d-a.sk, www.s-d-a.sk
-  **Slovenia:**
Tipteh d.o.o.
Tel: 012 005 150, Fax: 012 005 151
info@tipteh.si, www.tipteh.si
-  **South Africa:**
Vision Automation
Tel: 011 826 7365, Fax: 011 826 7361
info@visionautomation.co.za, www.unitronics.co.za
-  **Spain:**
SIDE, SA
Tel: 93 846 4801, Fax: 93 849 1394
info@side.es, www.side-automatizacion.com
-  **Sweden:**
SensorGruppen AB
Tel: 040 933030 and Fax: 040 933010
info@sensorgruppen.se, www.sensorgruppen.se
-  **Switzerland:**
COMAT AG Industrielle Elektronik
Tel: (0) 31 838 55 77, Fax: (0) 31 838 55 99
info@comat.ch, www.comat.ch
-  **Taiwan:**
MARK Automation Tek. Inc.
Tel: 02-25700992, Fax: 02-25700816
products@marktek.com.tw, www.marktek.com.tw
-  **Thailand:**
Themtech Company Ltd.
Tel: (2) 693 66 29, Fax: (2) 693-66 30
sales@themtech.co.th, www.themtech.co.th
-  **Turkey:**
YORUM OTOMASYON MALZEMELERİ SAN. VE TİC. A.Ş.
Tel: 216 364 69 69, Fax: 216 364 69 75
yorum@yorum-automation.com, www.yorum-automation.com
-  **Ukraine:**
Klinkmann Ukraine LLC
Tel: 44 495 33 40, Fax: 44 495 33 41
klinkmann.kiev@klinkmann.kiev.ua, www.klinkmann.com
-  **United Kingdom:**
Local UK distributors: contact Unitronics Ltd.
Tel (Israel): +972 3 977 88 94, Fax: +972 3 977 88 77
export@unitronics.com, www.unitronics.com
-  **USA:** Unitronics Inc.
Toll free: 866 666 6033
Tel: 617 657 6596, Fax: 617 657 6598
usa.sales@unitronics.com, www.unitronics.com
-  **Venezuela and Panama:**
Intrave, S.A.
Tel: +507 6275 0055, Fax: 0212 951 2521
Venezuela: +58-212-720 7805, Panamá: +507-838 5558
ventas@intrave.com, www.intrave.com, panama@intrave.com
-  **Vietnam:**
ANS
Tel: 8 3517 0401 Ext:17, Fax: 8 3517 0403
sales.ans@ansvietnam.com, www.ansvietnam.com



GEN00138-A0 - EUR