

PANELS

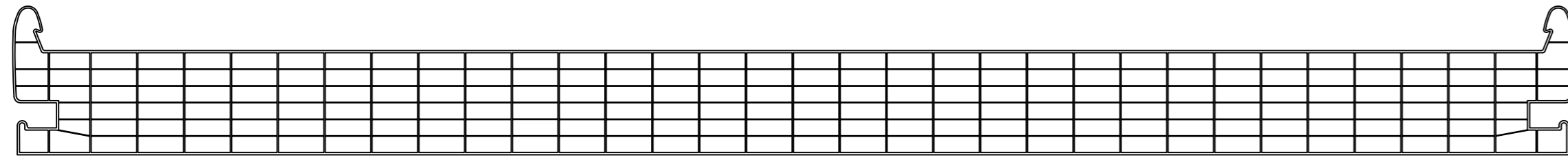

PC 2640-7-U



PC 2610-4

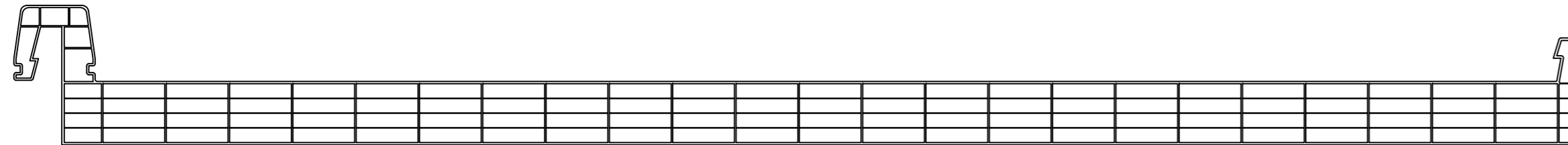

PC 2625-5



PC 2253-2

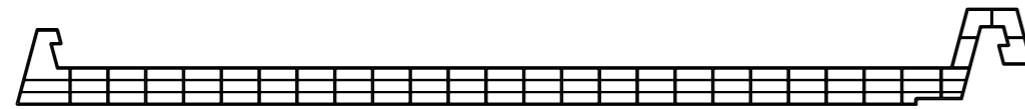

PC 2250-10-4

PC END-CAPS

non scale

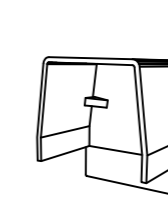

395005
for 2610-4

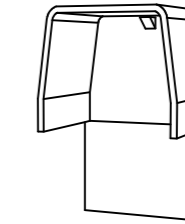

395004
for 2625-5

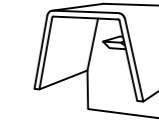

395006
for 2250-10-4

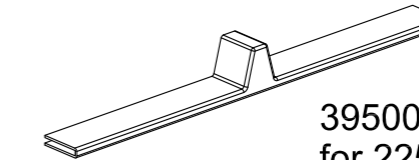

395001
for 2253-2

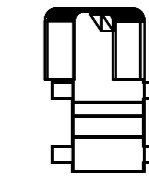

395008
for 2640-7-U

PROFILES / FASTENERS



494002
calotte
for 2625-5
& 2610-4



494003
for 2253-2



494004
for 2250-10-4



494010
for 2610-4

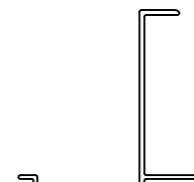

494025
for 2625-5

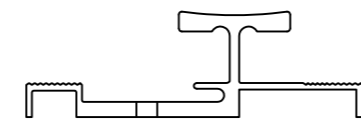

49404000
fastener for PC 2640-7-U

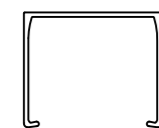

50008060

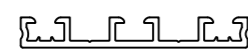

46006000



218400

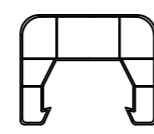

380061



461011



462511

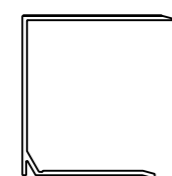

464011

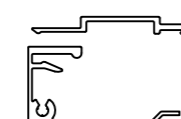

461040+492001

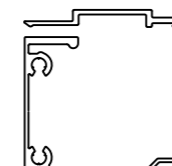

462540+492001

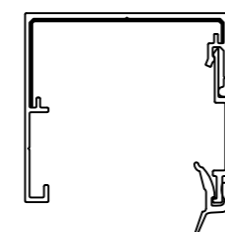

420040+492001

(493022 profile connector)

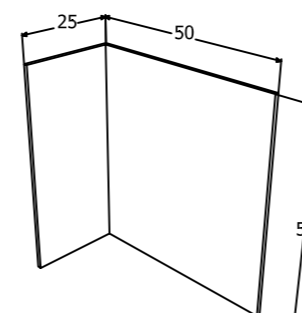

59w5025255

angle for 420040

GASKETS

non scale



902103
EPDM
black



902904
TPE
grey



902101
EPDM
black



902901
TPE
grey

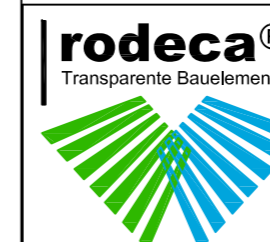

RODECA® GmbH
Freiherr vom Stein Str. 165
45473 Mülheim an der Ruhr
Tel. +49(0)208/76502-0
Fax +49(0)208/76502-17
E-Mail info@rodeca.de
Internet www.rodeca.de

Zeichnungsnummer	MFP Übersicht	Order	rodeca/Profile/Übersicht
Datum	25.06.2012	Bez.	MFP+Zubehör
Maßstab	1 : 2	Technische Änderung vorbehalten	
Unsere Zeichnungen dürfen weder vervielfältigt, noch Dritten zugänglich gemacht werden. Der Mißbrauch hat strafrechtliche Folgen.			